



Oficina: Inovação Farmacêutica & Propriedade Intelectual

Universidade Federal do Espírito Santo
Vitória, ES
13 de agosto de 2018

Apoiadores



Mantenedores da Academia de Ciências Farmacêuticas do Brasil

Diamante:



Ouro:



Prata:



Uso Estratégico de Propriedade Intelectual e Informações Tecnológicas

Foco no Setor Farmacêutico

Universidade Federal do Espírito Santo
Vitória, ES
13 de agosto de 2018





- **Ministrante**

Henry Suzuki

Sócio Diretor da Axonal Consultoria Tecnológica Ltda. (Brasil), Principal da Innovalyst LLC (Estados Unidos), Consultor Colaborador da Questel Consulting (França), Agente da Propriedade Industrial (INPI BR). Graduado em Farmácia e Bioquímica pela FCF-USP e pós-graduado em Administração de Empresas pela ESPM. Titular da Cadeira nº 2 da Academia Nacional de Farmácia. Empreendedor e Inventor. Membro da rede Mentores do Brasil.

henry.suzuki@axonal.com.br



Uso Estratégico de Propriedade Intelectual e Informações Tecnológicas

Foco no Setor Farmacêutico

- Agenda

- Propriedade Intelectual no contexto farmacêutico, com destaque a patentes
- Uso estratégico de patentes e informações patentárias
- Ferramentas e técnicas de busca e análise de informações tecnológicas
- Fontes, sistemas de busca e análise de informações com foco na área farmacêutica
- Exemplo de mapeamento de segmento tecnológico

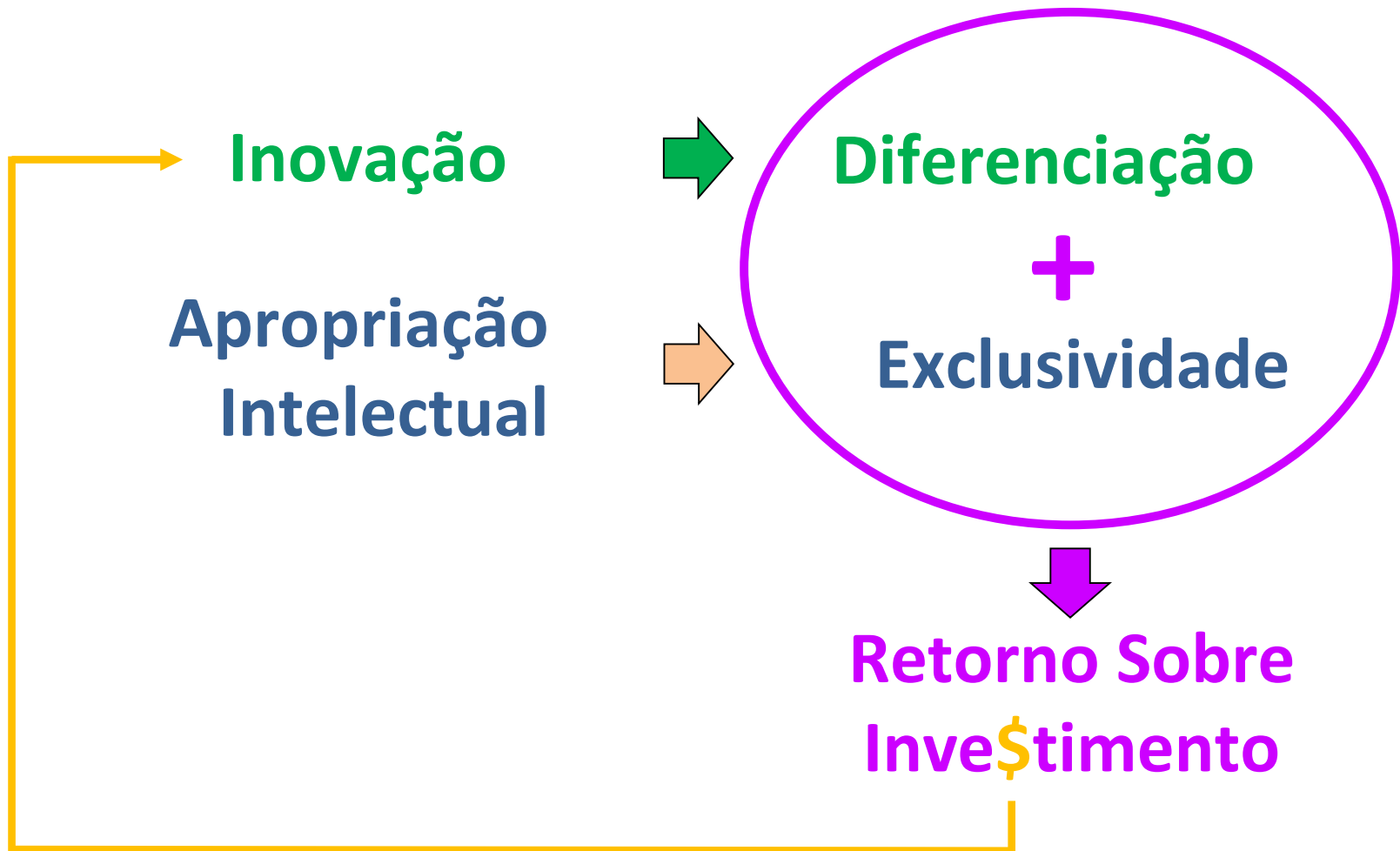


Uso Estratégico de Propriedade Intelectual e Informações Tecnológicas

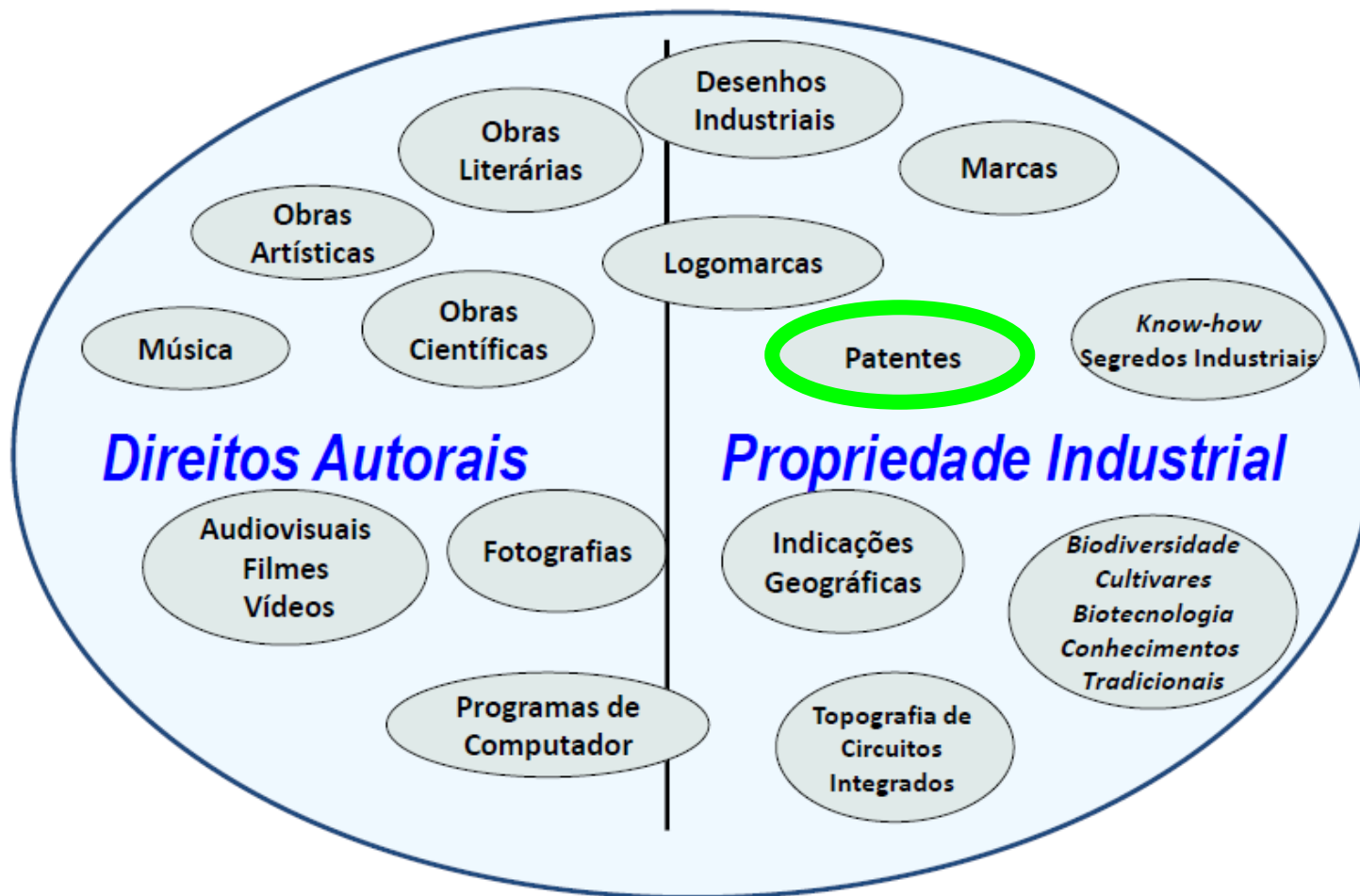
Foco no Setor Farmacêutico

- Agenda
 - **Propriedade Intelectual no contexto farmacêutico, com destaque a patentes**
 - Uso estratégico de patentes e informações patentárias
 - Ferramentas e técnicas de busca e análise de informações tecnológicas
 - Fontes, sistemas de busca e análise de informações com foco na área farmacêutica
 - Exemplo de mapeamento de segmento tecnológico

Inovação & Propriedade Intelectual



Propriedade Intelectual em sua várias dimensões, com destaque a patentes



Cartilha da Propriedade Intelectual 2015 – OAB-RS

http://www.oabrs.org.br/arquivos/file_55d349cb980bb.pdf



SUMÁRIO

OBRAS LITERÁRIAS.....	6 e 7
OBRAS MUSICAIS.....	8 e 9
OBRAS AUDIOVISUAIS.....	10 e 11
OBRAS DE ARTES PLÁSTICAS E FOTOGRAFIAS.....	12 e 13
PROJETOS ARQUITETÔNICOS.....	14 e 15
TRADUÇÕES E OBRAS DERIVADAS.....	16 e 17
ARTISTAS INTÉRPRETES OU EXECUTANTES, PRODUTORES FONOGRAFICOS E EMPRESAS DE RADIODIFUSÃO.....	18 e 19
PROGRAMAS DE COMPUTADOR.....	20 e 21
INVENÇÕES.....	22 e 23
MODELOS DE UTILIDADE.....	24 e 25
DESIGN.....	26 e 27
KNOW HOW E SEGREDOS INDUSTRIAIS.....	28 e 29
TOPOGRAFIA DE CIRCUITOS INTEGRADOS.....	30 e 31
MARCAS.....	32 e 33
OBRAS PUBLICITÁRIAS.....	34 e 35
MARCAS DE CERTIFICAÇÃO.....	36 e 37
MARCAS COLETIVAS.....	38 e 39
NOMES EMPRESARIAIS.....	40 e 41
NOMES DE DOMÍNIO.....	42 e 43
INDICAÇÕES GEOGRÁFICAS.....	44 e 45
CULTIVARES.....	46 e 47
CONCORRÊNCIA DESLEAL.....	48 e 49

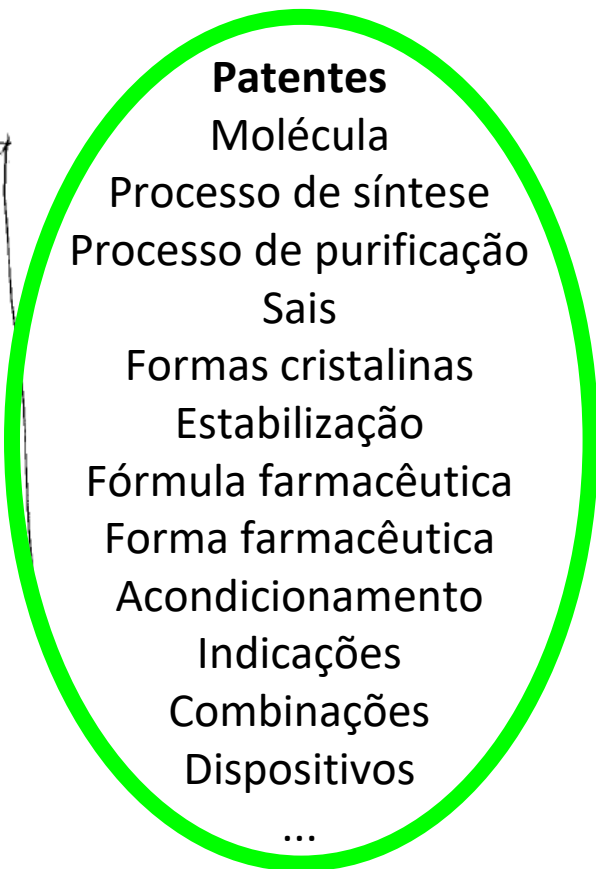
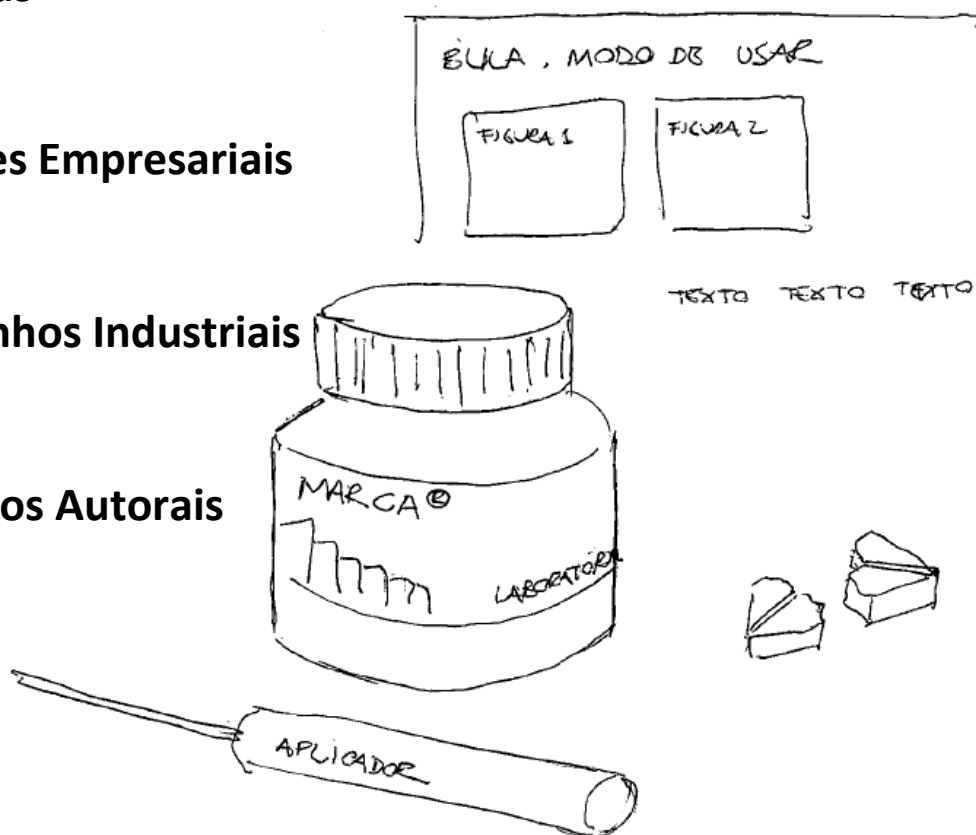
Propriedade Intelectual em sua várias dimensões, com destaque a patentes

Marcas

Nomes Empresariais

Desenhos Industriais

Direitos Autorais



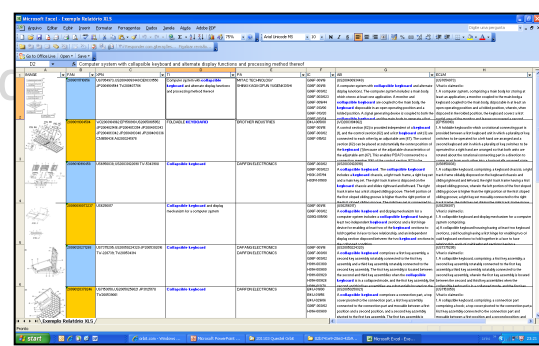
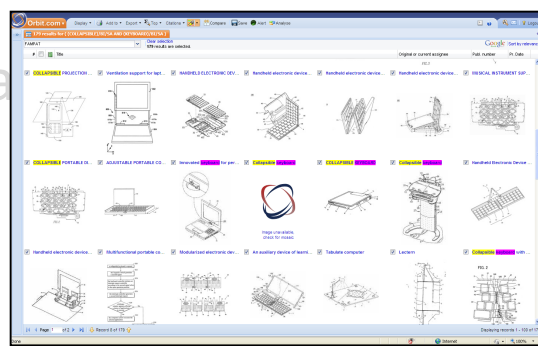
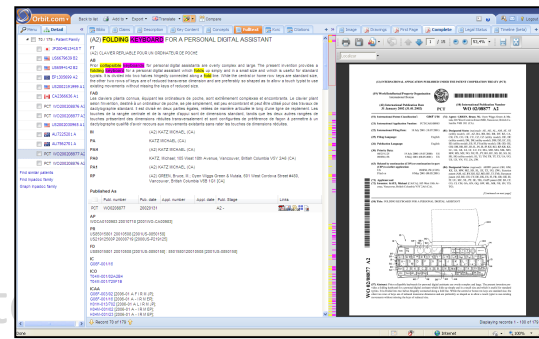
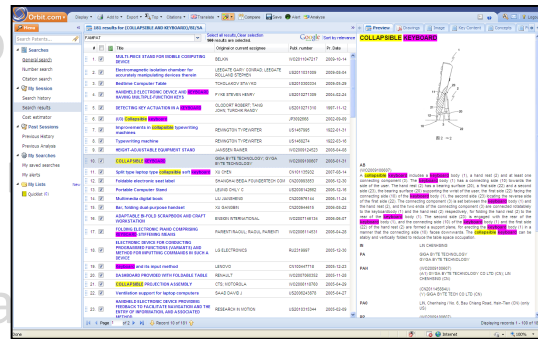
Segredos industriais

Uso estratégico de patentes e informações patentárias

- Estudos de patenteabilidade e (in)validade
- Estudos de liberdade de comercialização
- Mapeamento de segmentos tecnológicos

O que?

- Invenção
- Patenteabilidade
- Monitoramento
- Identificação
- Etc.



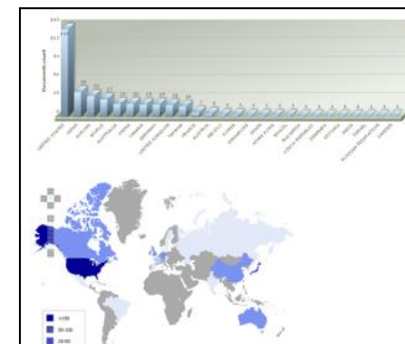
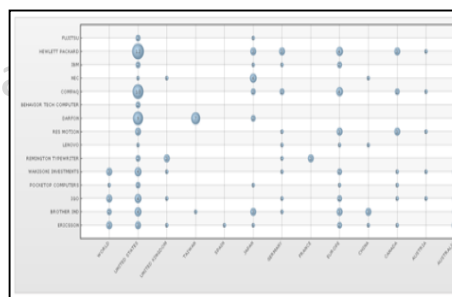
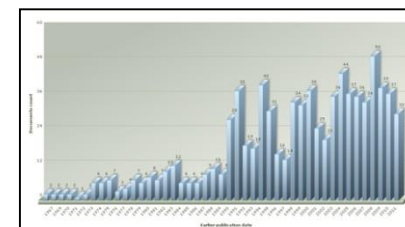
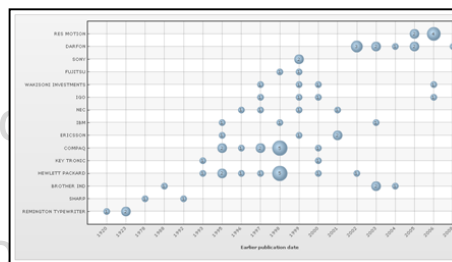
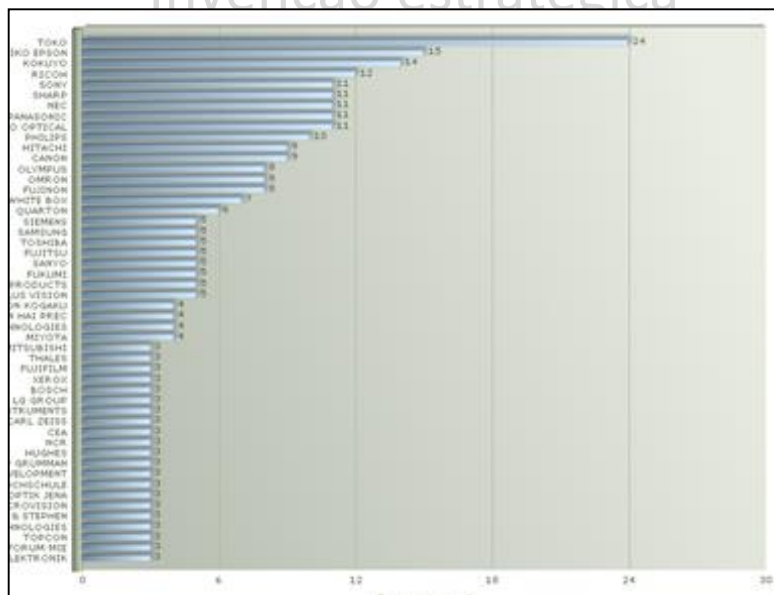
Uso estratégico de patentes e informações patentárias

- Estudos de patenteabilidade e (in)validade
- Estudos de liberdade de comercialização
- Mapeamento de segmentos tecnológicos
- Invenção estratégica

Quem ?

Quando?

Onde?

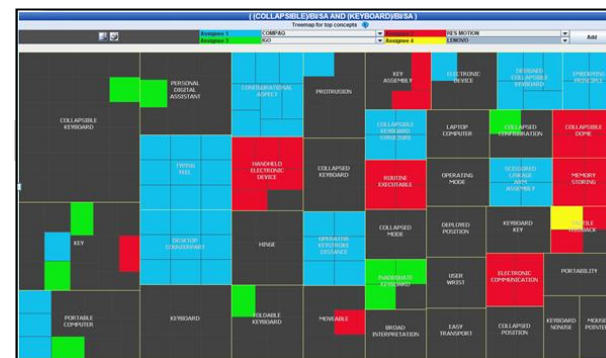
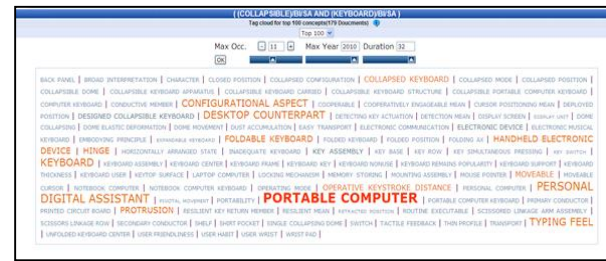
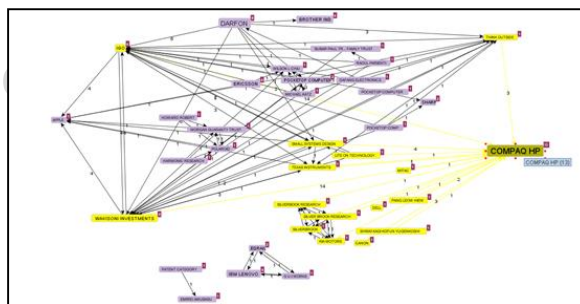
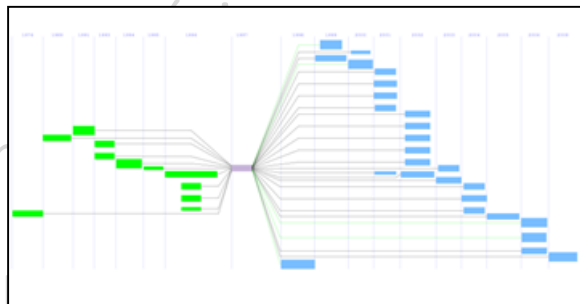


Uso estratégico de patentes e informações patentárias

- Estudos de patenteabilidade e (in)validade
- Estudos de liberdade de comercialização
- Mapeamento de segmentos tecnológicos

Como?

- Invenção
- Patentear
- Monitorar
- Identificar
- Etc.

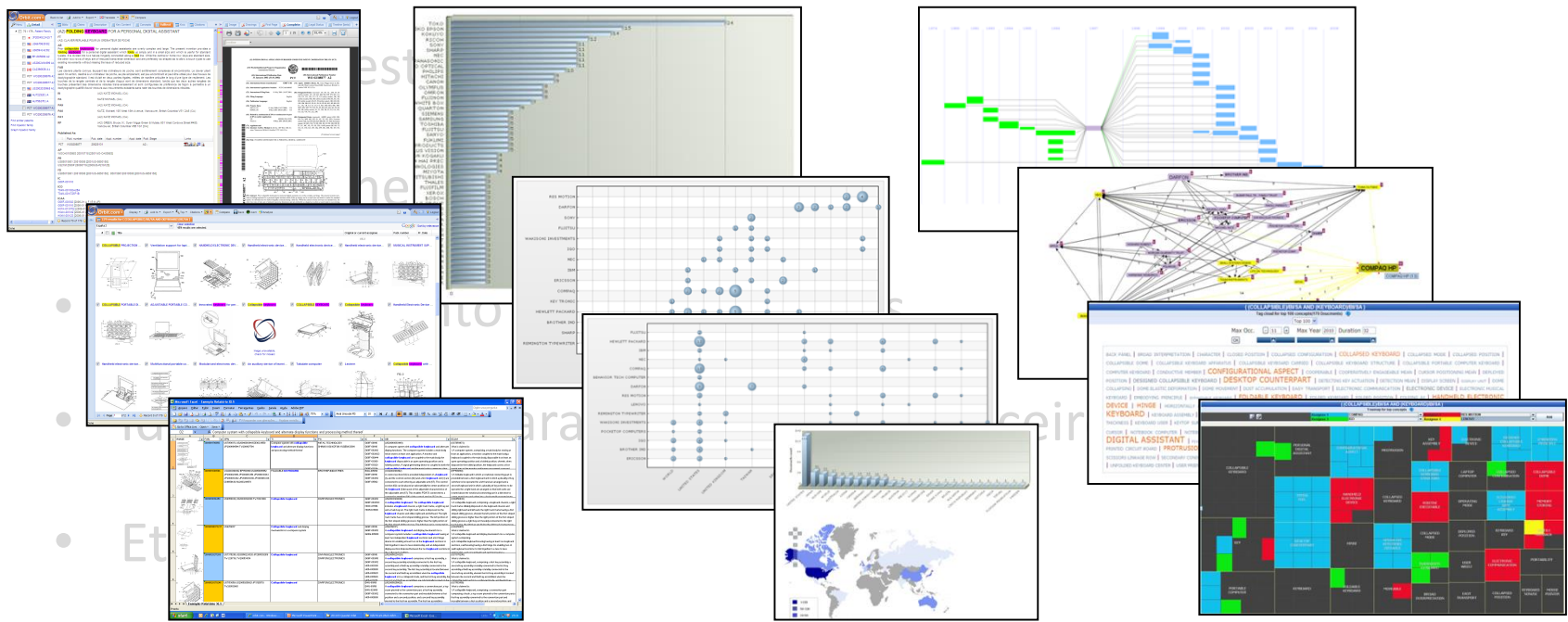


Uso estratégico de patentes e informações patentárias

- Estudos de patenteabilidade e (in)validade
- Estudos de liberdade de comercialização
- Mapeamento de segmentos tecnológicos

Por quê?

E daí ?



Propriedade Intelectual em sua várias dimensões, com destaque a patentes



- O que é patente
- O que é patenteável
- O que não é patenteável
- Como é um documento de patente
- Como definir o escopo de proteção
- Como é o processo de patenteamento

Propriedade Intelectual em sua várias dimensões, com destaque a patentes



- O que é patente
- O que é patenteável
- O que não é patenteável
- Como é um documento de patente
- Como definir o escopo de proteção
- Como é o processo de patenteamento

O que é patente



- Patente é um título de propriedade que confere ao seu titular o direito de impedir terceiros explorarem sua invenção, em um determinado território, por um limitado período de tempo, em troca da descrição da invenção.

O que é patente



- Patente é um **título de propriedade** que confere ao seu titular direito de impedir terceiros explorarem sua invenção, em um determinado território, por um limitado período de tempo, em troca da descrição da invenção.

Lei da Propriedade Industrial nº 9.279/96

http://www.planalto.gov.br/ccivil_03/leis/L9279.htm

Diversos Tratados Internacionais



Presidência da República

Casa Civil

Subchefia para Assuntos Jurídicos

LEI Nº 9.279, DE 14 DE MAIO DE 1996.

Regula direitos e obrigações relativos à propriedade industrial.

O PRESIDENTE DA REPÚBLICA Faço saber que o Congresso Nacional decreta e eu sanciono a seguinte Lei:

DISPOSIÇÕES PRELIMINARES

Art. 1º Esta Lei regula direitos e obrigações relativos à propriedade industrial.

Art. 2º A proteção dos direitos relativos à propriedade industrial, considerado o seu interesse social e o desenvolvimento tecnológico e econômico do País, efetua-se mediante:

I - concessão de patentes de invenção e de modelo de utilidade;

II - concessão de registro de desenho industrial;

III - concessão de registro de marca;

IV - repressão às falsas indicações geográficas; e

V - repressão à concorrência desleal.

O que é patente



- Patente é um título de propriedade que confere ao seu titular o **direito de impedir terceiros explorarem sua invenção**, em um determinado território, por um limitado período de tempo, em troca da descrição da invenção.

Direito de Impedir Terceiros

≠

Direito de Explorar

CAPÍTULO V

DA PROTEÇÃO CONFERIDA PELA PATENTE

Seção I

Dos Direitos

Art. 41. A extensão da proteção conferida pela patente será determinada pelo teor das reivindicações, interpretado com base no relatório descritivo e nos desenhos.

Art. 42. A patente confere ao seu titular o direito de impedir terceiro, sem o seu consentimento, de produzir, usar, colocar à venda, vender ou importar com estes propósitos:

I - produto objeto de patente;

II - processo ou produto obtido diretamente por processo patenteado.

§ 1º Ao titular da patente é assegurado ainda o direito de impedir que terceiros contribuam para que outros pratiquem os atos referidos neste artigo.

§ 2º Ocorrerá violação de direito da patente de processo, a que se refere o inciso II, quando o possuidor ou proprietário não comprovar, mediante determinação judicial específica, que o seu produto foi obtido por processo de fabricação diverso daquele protegido pela patente.

Art. 43. O disposto no artigo anterior não se aplica:

PATENTE (A) - HENRY
DISPOSITIVO PARA SENTAR
CARACTERIZADO POR
CONTER:

- QUATRO PÉS
- UM ASSENTO E
- UM ENCOSTO



PATENTE (B) - ZÉ
DISPOSITIVO PARA SENTAR
CONTENDO PELO MENOS
UM PÉ E UM ASSENTO,
CARACTERIZADO POR
CONTER PELO MENOS UMA
RODA DEBAIXO DE CADA PÉ



PATENTE (A) - HENRY
DISPOSITIVO PARA SENTAR
CARACTERIZADO POR
CONTER:

- QUATRO PÉS
- UM ASSENTO E
- UM ENCOSTO

PATENTE (B) - ZÉ
DISPOSITIVO PARA SENTAR
CONTENDO PELO MENOS
UM PÉ E UM ASSENTO,
CARACTERIZADO POR
CONTER PELO MENOS UMA
RODA DEBAIXO DE CADA PÉ





PATENTE (C) - MARIA
DISPOSITIVO PARA SENTAR
CONTENDO PELO MENOS
UM PÉ E UM ASSENTO,
CARACTERIZADO POR
CONTER ADICIONALMENTE
PELO MENOS UM BRAÇO

PATENTE (D) - JOANA
DISPOSITIVO PARA SENTAR
CONTENDO PELO MENOS
UM PÉ E UM ASSENTO E
PELO MENOS UM BRAÇO,
CARACTERIZADO POR
CONTER, ADICIONALMENTE
PELO MENOS UMA MESA
LIGADA A UM DOS BRAÇOS



PATENTE (A) - HENRY

DISPOSITIVO PARA SENTAR
CARACTERIZADO POR
CONTER:

- QUATRO PÉS
- UM ASSENTO E
- UM ENCOSTO

PATENTE (B) - ZÉ

DISPOSITIVO PARA SENTAR
CONTENDO PELO MENOS
UM PÉ E UM ASSENTO,
CARACTERIZADO POR
CONTER PELO MENOS UMA
RODA DEBAIXO DE CADA PÉ



PATENTE (D) - JOANA

DISPOSITIVO PARA SENTAR
CONTENDO PELO MENOS
UM PÉ E UM ASSENTO E
PELO MENOS UM BRAÇO,
CARACTERIZADO POR
CONTER, ADICIONALMENTE
PELO MENOS UMA MESA
LIGADA AO BRAÇO

PATENTE (C) - MARIA

DISPOSITIVO PARA SENTAR
CONTENDO PELO MENOS
UM PÉ E UM ASSENTO,
CARACTERIZADO POR
CONTER ADICIONALMENTE
PELO MENOS UM BRAÇO

O que é patente



- Patente é um título de propriedade que confere ao seu titular direito de impedir terceiros explorarem sua invenção, **em um determinado território**, por um limitado período de tempo, em troca da descrição da invenção.

Para uma patente ter efeito em um determinado país, deverá ser depositada e concedida naquele país.

O que é patente



- Patente é um título de propriedade que confere ao seu titular direito de impedir terceiros explorarem sua invenção, em um determinado território, **por um limitado período de tempo**, em troca da descrição da invenção.

Patente de Invenção: 20 Anos após o depósito
ou pelo menos 10 anos após a concessão

Patente de Modelo de Utilidade: 15 Anos após o depósito
ou pelo menos 7 anos após a concessão

O que é patente



- Patente é um título de propriedade que confere ao seu titular o direito de impedir terceiros explorarem sua invenção, em um determinado território, por um limitado período de tempo, **em troca da descrição da invenção.**

O escopo de proteção de uma patente depende da descrição da invenção. Em determinados casos, a manutenção de segredo industrial pode ser mais adequada.

Das Condições do Pedido

Art. 22. O pedido de patente de invenção terá de se referir a uma única invenção ou a um grupo de invenções inter-relacionadas de maneira a compreenderem um único conceito inventivo.

Art. 23. O pedido de patente de modelo de utilidade terá de se referir a um único modelo principal, que poderá incluir uma pluralidade de elementos distintos, adicionais ou variantes construtivas ou configurativas, desde que mantida a unidade técnico-funcional e corporal do objeto.

Art. 24. O relatório deverá descrever clara e suficientemente o objeto, de modo a possibilitar sua realização por técnico no assunto e indicar, quando for o caso, a melhor forma de execução.

Parágrafo único. No caso de material biológico essencial à realização prática do objeto do pedido, que não possa ser descrito na forma deste artigo e que não estiver acessível ao público, o relatório será suplementado por depósito do material em instituição autorizada pelo INPI ou indicada em acordo internacional.

Art. 25. As reivindicações deverão ser fundamentadas no relatório descritivo, caracterizando as particularidades do pedido e definindo, de modo claro e preciso, a matéria objeto da proteção.

Propriedade Intelectual em sua várias dimensões, com destaque a patentes



- O que é patente
- **O que é patenteável**
- O que não é patenteável
- Como é um documento de patente
- Como definir o escopo de proteção
- Como é o processo de patenteamento

DAS INVENÇÕES E DOS MODELOS DE UTILIDADE PATENTEÁVEIS

Art. 8º É patenteável a invenção que atenda aos requisitos de novidade, atividade inventiva e aplicação industrial.

Art. 9º É patenteável como modelo de utilidade o objeto de uso prático, ou parte deste, suscetível de aplicação industrial, que apresente nova forma ou disposição, envolvendo ato inventivo, que resulte em melhoria funcional no seu uso ou em sua fabricação.

Art. 10. Não se considera invenção nem modelo de utilidade:

I - descobertas, teorias científicas e métodos matemáticos;

II - concepções puramente abstratas;

III - esquemas, planos, princípios ou métodos comerciais, contábeis, financeiros, educativos, publicitários, de sorteio e de fiscalização;

IV - as obras literárias, arquitetônicas, artísticas e científicas ou qualquer criação estética;

O que é patenteável



- É patenteável a invenção que atenda aos requisitos de novidade, atividade inventiva e aplicação industrial.

O que é patenteável



- É patenteável a invenção que atenda aos requisitos de **novidade**, atividade inventiva e aplicação industrial.

Art. 11. A invenção e o modelo de utilidade são considerados novos quando não compreendidos no estado da técnica.

§ 1º O estado da técnica é constituído por tudo aquilo tornado acessível ao público antes da data de depósito do pedido de patente, por descrição escrita ou oral, por uso ou qualquer outro meio, no Brasil ou no exterior, ressalvado o disposto nos arts. 12, 16 e 17.

§ 2º Para fins de aferição da novidade, o conteúdo completo de pedido depositado no Brasil, e ainda não publicado, será considerado estado da técnica a partir da data de depósito, ou da prioridade reivindicada, desde que venha a ser publicado, mesmo que subseqüentemente.

§ 3º O disposto no parágrafo anterior será aplicado ao pedido internacional de patente depositado segundo tratado ou convenção em vigor no Brasil, desde que haja processamento nacional.

Art. 12. Não será considerada como estado da técnica a divulgação de invenção ou modelo de utilidade, quando ocorrida durante os 12 (doze) meses que precederem a data de depósito ou a da prioridade do pedido de patente, se promovida:

I - pelo inventor;

II - pelo Instituto Nacional da Propriedade Industrial - INPI, através de publicação oficial do pedido de patente depositado sem o consentimento do inventor, baseado em informações deste obtidas ou em decorrência de atos por ele realizados; ou

O que é patenteável



- É patenteável a invenção que atenda aos requisitos de novidade, **atividade inventiva** e aplicação industrial.

Art. 13. A invenção é dotada de atividade inventiva sempre que, para um técnico no assunto, não decorra de maneira evidente ou óbvia do estado da técnica.

Art. 14. O modelo de utilidade é dotado de ato inventivo sempre que, para um técnico no assunto, não decorra de maneira comum ou vulgar do estado da técnica.

O que é patenteável



- É patenteável a invenção que atenda aos requisitos de novidade, atividade inventiva e **aplicação industrial.**

Art. 15. A invenção e o modelo de utilidade são considerados suscetíveis de aplicação industrial quando possam ser utilizados ou produzidos em qualquer tipo de indústria.

Propriedade Intelectual em sua várias dimensões, com destaque a patentes



- O que é patente
- O que é patenteável
- **O que não é patenteável**
- Como é um documento de patente
- Como definir o escopo de proteção
- Como é o processo de patenteamento

Das Invenções e Dos Modelos de Utilidade Não Patenteáveis

Art. 18. Não são patenteáveis:

I - o que for contrário à moral, aos bons costumes e à segurança, à ordem e à saúde públicas;

II - as substâncias, matérias, misturas, elementos ou produtos de qualquer espécie, bem como a modificação de suas propriedades físico-químicas e os respectivos processos de obtenção ou modificação, quando resultantes de transformação do núcleo atômico; e

III - o todo ou parte dos seres vivos, exceto os microorganismos transgênicos que atendam aos três requisitos de patenteabilidade - novidade, atividade inventiva e aplicação industrial - previstos no art. 8º e que não sejam mera descoberta.

Parágrafo único. Para os fins desta Lei, microorganismos transgênicos são organismos, exceto o todo ou parte de plantas ou de animais, que expressem, mediante intervenção humana direta em sua composição genética, uma característica normalmente não alcançável pela espécie em condições naturais.

Art. 10. Não se considera invenção nem modelo de utilidade:

I - descobertas, teorias científicas e métodos matemáticos;

II - concepções puramente abstratas;

III - esquemas, planos, princípios ou métodos comerciais, contábeis, financeiros, educativos, publicitários, de sorteio e de fiscalização;

IV - as obras literárias, arquitetônicas, artísticas e científicas ou qualquer criação estética;

V - programas de computador em si;

VI - apresentação de informações;

VII - regras de jogo;

VIII - técnicas e métodos operatórios ou cirúrgicos, bem como métodos terapêuticos ou de diagnóstico, para aplicação no corpo humano ou animal; e

IX - o todo ou parte de seres vivos naturais e materiais biológicos encontrados na natureza, ou ainda que dela isolados, inclusive o genoma ou germoplasma de qualquer ser vivo natural e os processos biológicos naturais.

Propriedade Intelectual em sua várias dimensões, com destaque a patentes



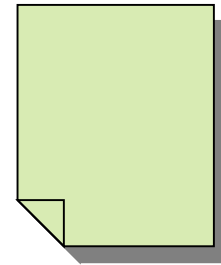
- O que é patente
- O que é patenteável
- O que não é patenteável
- **Como é um documento de patente**
- Como definir o escopo de proteção
- Como é o processo de patenteamento

Como é um documento de patente



Publicações de patentes têm uma estrutura padronizada, composta por:

- Titular
- Inventor
- Classificação
- Prioridade
- Anterioridades
- Resumo
- Relatório descritivo
- Reivindicações
- Desenhos (eventualmente)





US007146667B2

(12) **United States Patent**
Elsener

(10) **Patent No.:** US 7,146,667 B2
(45) **Date of Patent:** Dec. 12, 2006

(54) **POCKET TOOL**
(75) Inventor: **Carl Elsener**, Ibach (CH)
(73) Assignee: **Victorinox AG**, Ibach (CH)
(*) Notice: Subject to any disclaimer, the term of this patent is extended or adjusted under 35 U.S.C. 154(b) by 0 days.

6,341,423 B1 * 1/2002 Taggart et al. 30/169
6,394,813 B1 * 5/2002 Stout et al. 439/11
6,561,421 B1 * 5/2003 Yu 235/451
6,675,419 B1 * 1/2004 Rivera 7/128
2004/0080989 A1 * 4/2004 Yu 365/200

FOREIGN PATENT DOCUMENTS

JP 2003 - 10570 1/2003

* cited by examiner

Primary Examiner—David B. Thomas
(74) *Attorney, Agent, or Firm*—Fross Zelnick Lehrman & Zissu, P.C.; Philip T. Shannon, Esq.; Charles T. J. Weigell, Esq.

(21) Appl. No.: **10/965,638**

(22) Filed: **Oct. 14, 2004**

(65) **Prior Publication Data**
US 2005/0081302 A1 Apr. 21, 2005

(30) **Foreign Application Priority Data**
Oct. 17, 2003 (AT) A 1650/2003

(51) **Int. Cl.**
B26B 11/00 (2006.01)

(52) **U.S. Cl.** 7/118; 7/170

(58) **Field of Classification Search** 7/118,
7/158, 170; 81/177.4; 365/200
See application file for complete search history.

(56) **References Cited**

U.S. PATENT DOCUMENTS

4,854,045 A * 8/1989 Schaub 30/155
6,273,582 B1 * 8/2001 Taggart et al. 362/119

(57) **ABSTRACT**

The invention specifies a pocket tool, particularly a pocket knife (1) or plate-like tool card, comprising a housing (2) with at least one receiving area (10), and at least two functional components (11) movable from a storage position within the receiving area (10), into a working position outside of the receiving area (10). The first functional component (11) is designed as a tool, particularly a pair of scissors (16) or knife (1). The second functional component (11) has a support casing (25) and is equipped with a recordable and readable, nonvolatile memory, as well as with an interface (24). A releasable locking device and a longitudinal guide or pivot bearing are arranged between the support casing (25) of the second functional component (11) and the housing (2).

118 Claims, 14 Drawing Sheets

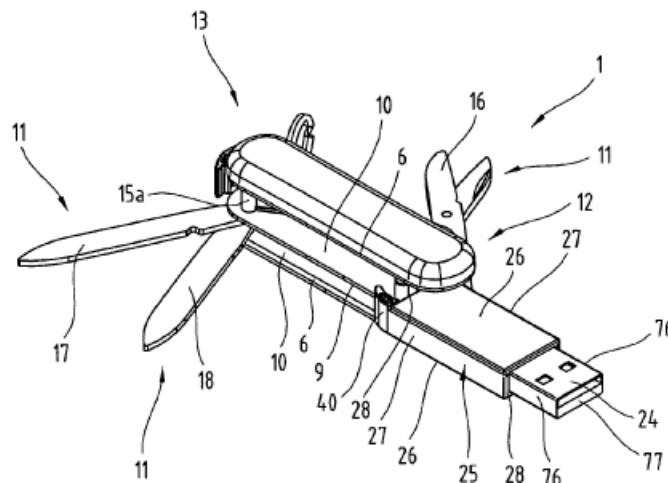


Fig. 3

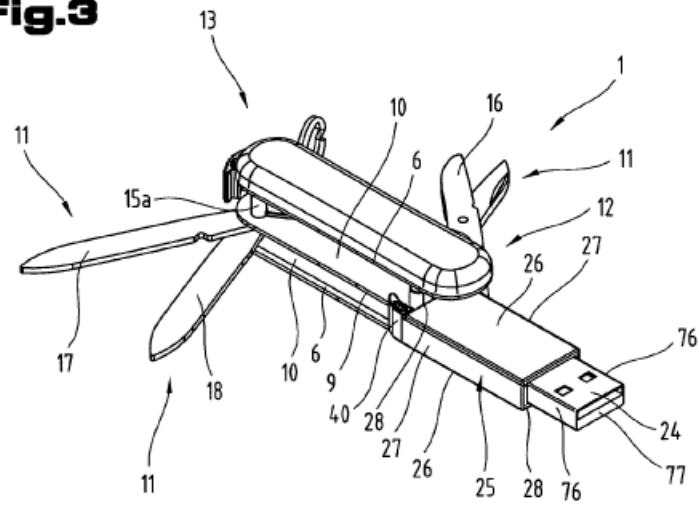


Fig. 4

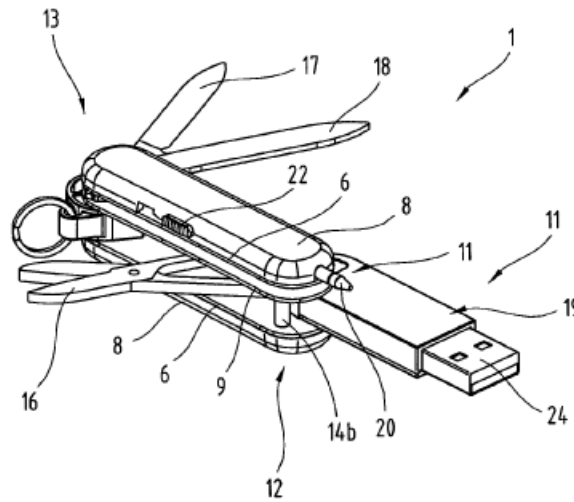


Fig. 5

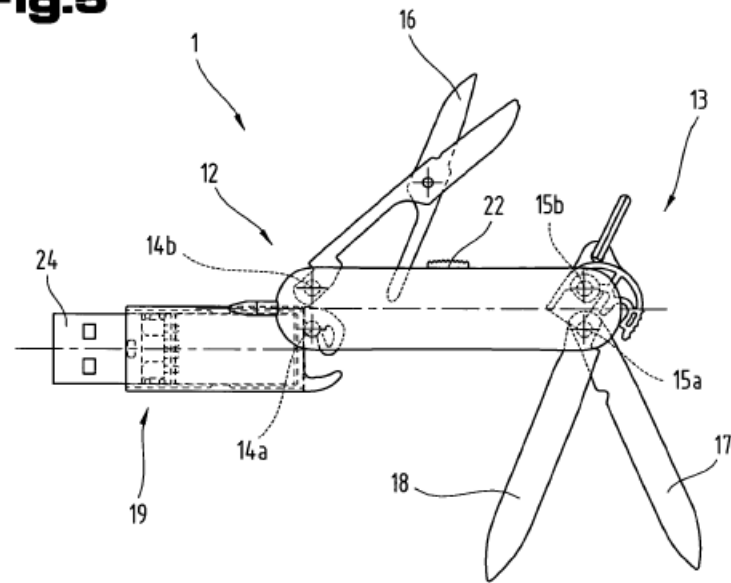
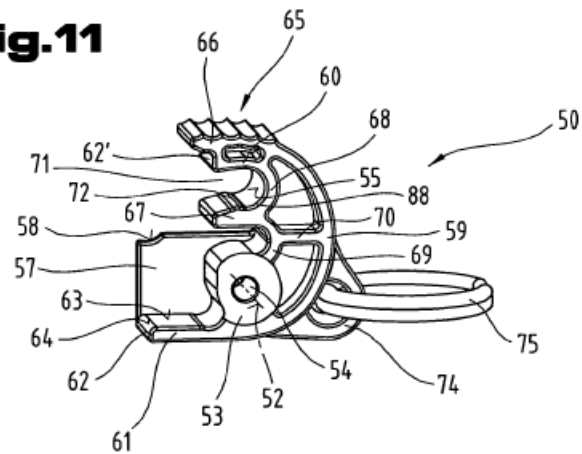


Fig. 11



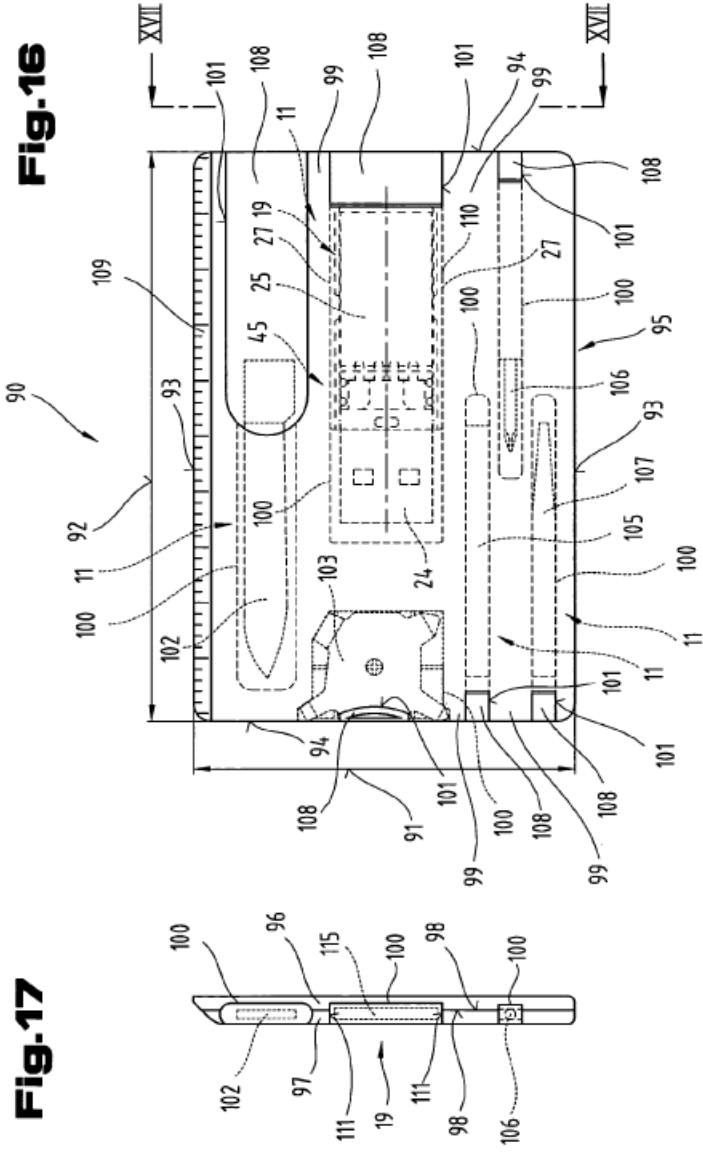


Fig.19

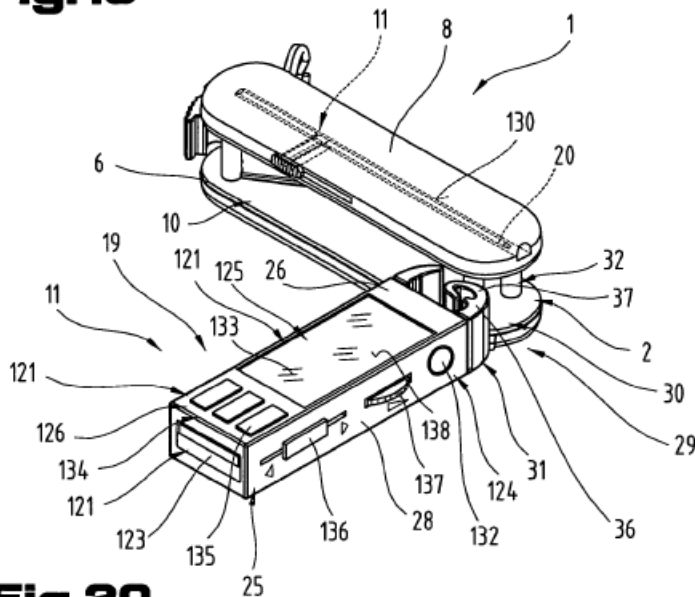


Fig.20

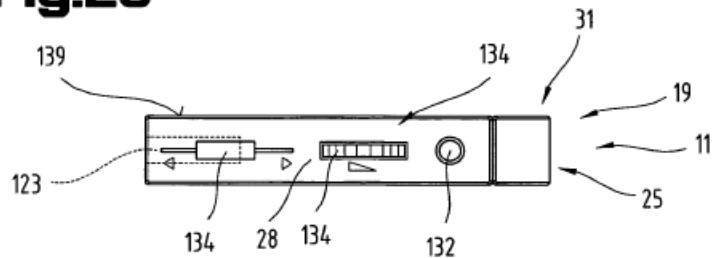
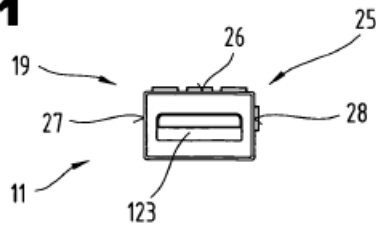


Fig.21



1
POCKET TOOL

CROSS REFERENCE TO RELATED
APPLICATIONS

Applicant claims priority under 35 U.S.C. §119 of AUSTRALIAN Patent Application No. A 1659/2003 filed on Oct. 17, 2003.

BACKGROUND OF THE INVENTION

1. Field of the Invention

The invention relates to a pocket tool as defined in the introductory parts of claims 1 and 44. Furthermore, it relates to a functional component as defined in the introductory part of claim 116.

2. The Prior Art

Different designs of pocket tools in the form of pocket knives or plate-shaped tool cards are known from WO 01/39629 A1 and CH 686 173 A5. Such tools comprise a housing with at least one receiving area and a number of functional components that are movable from a storage position within the receiving area, to a working position outside of the receiving area. On the one hand, such functional components are formed by tools such as, for example a pair of scissors, a knife, a screwdriver and the like, and by utensils such as, for example tooth picks, pincers or cleaning needles, on the other hand. The functionality of such known pocket tools is extended in that a battery-buffered random access memory (RAM) main memory, or a read-only memory (ROM) memory is arranged within the housing. Said memories are arranged locally fixed in the pocket knife. Programs or data can be stored in and recalled from such memories. The main memory is referred to also as a so-called volatile storage because it has to be supplied with the required voltage, so it will not lose the memory contents even if the supply voltage is shut off. Arranging the required battery in the housing leads to an overall enlargement of the size of the pocket tool, or that only a few functional components can be arranged in the housing with comparatively no change in the outside dimensions.

If the memory is designed as a ROM memory, data can only be read out from the memory; however, no data can be written into the memory, which means the user can exclusively utilize the data or programs preset by the manufacturer of the pocket tool, which highly restricts the field of application of such a pocket tool.

Furthermore, a multifunctional tool is known from WO 99/56918 A1, which has at least one measuring, input and display device for at least one physical quantity, said device being arranged in or on the tool. The display device may be formed in this connection by an LCD display serving for the visual output of physical quantities. The measuring and display device can be supplied with current by means of a battery and/or a solar cell. Furthermore, provision may be made in or on the tool for an interface in order to input data for the measuring and display device, and to transmit data from the latter. For converting the measured and/or input value into an electrical signal, provision can be made for a converter or microprocessor for converting the electrical signal into a standardized physical unit.

Such a multifunctional tool does in fact extend the functionality of a pocket knife or manual tool; however, the scope of functions is exclusively limited to the processing of detectable measured physical values.

The pocket tools known from the prior art are generally found to be lacking with respect to their capability of

2

processing digital data and outputting the latter in a form the user can detect, so there is a demand for additionally extending the scope of functions of pocket tools, while maintaining at the same time in the usual manner the scope of functions to which the user is accustomed to, such functions being achievable with functional tools or components such as, e.g. screwdrivers, knives, scissors, and utensils such as, e.g. toothpicks etc.

SUMMARY OF THE INVENTION

The present invention is based on the problem to extend the range of application of a pocket tool without influencing thereby the dimensions of the pocket tool as such. A part problem of the present invention consists in expanding the scope of functions and the range of application of the pocket tool with respect to its capability of processing digital data, the objective being to maintain the mechanical functionality through the availability of tools and utensils.

The problem of the invention is resolved by the features defined herein. The benefits resulting from said features include that the second functional component in the form of an electronic module can be moved for its application into a position outside of the receiving range of the pocket tool, achieving in this manner superior accessibility particularly to the interface. In the nonvolatile storage, it is possible to write in and read out data, for example text data or data as video and language information and the like, and programs, e.g. application programs and the like, whereby the non-volatile storage is wherein contrary to the known volatile main memories, where data and programs can be read in and written out as well, the electrical energy supply can be dispensed with, and the space volume otherwise required for accommodating, e.g. a battery in the housing, can be used either as an additional storage space or for additional tools. The functionality of the pocket tools, and in particular the memory capacity or the range of application as a tool can be significantly raised in this way without substantially increasing its outside dimensions. It is advantageous also that a releasable locking device is arranged between the functional component and the housing, because any unintentional removal of the functional component from its storage position, for example, is excluded to the greatest possible extent. The longitudinal guide or pivot-mount between the support casing of the second functional component, and the housing of the pocket tool effect a smooth movement of the second functional component vis-à-vis the receiving area or a bearing axle arranged in the housing.

One embodiment is advantageous in that, on the one hand, the memory and the control circuit and/or at least one peripheral are arranged within the support casing, which is enclosed on all sides and consequently protected from environmental influences such as, e.g. moisture, dust and the like; and that the support casing has high mechanical stability and is insensitive to pressure stress, on the other hand. The interface represents a link between the memory and an external EDP system.

As disclosed, it is also possible to maintain a standardized length of a pocket tool known in the prior art.

Beneficial sequence activities for the second functional component are also disclosed.

Further developments of the invention are advantageous in that the second functional component forming the electronics module is, in its working position, now completely separated from the housing, and can be used independently of the latter. Particularly the increasingly stricter security regulations in airline traffic prohibit passengers from using

be parameterized in a manner simple for the user. Particularly intuitive and user-friendly control is feasible via a user surface allotted to the controlling device, and by means of an electronic position detection system, particularly a touch screen, it is possible to provide a particularly compact structure of the control circuit, display and controlling device with just a few individual components.

Other useful exemplified embodiments of the pocket tool are disclosed that provide for simple controllability and adjustability of the functions of the control circuit.

Another useful embodiment of a peripheral, whereby it is advantageous particularly on account of an energy supply device formed by a self-sufficient energy storage according to claim 112, is that the pocket tool is not restricted in its mobility, and that the control circuit can be operated substantially without being dependent on any location. Particularly chemoelectrical energy storage means and especially rechargeable batteries can be employed in this connection, for example such as lithium or lithium-polymer accumulators, or one-way batteries.

Furthermore, a disclosed design variation is beneficial in that owing to the energy supply system provided in the pocket tool in the form of electrical conductors, the pocket tool either does not require its own energy storage means because electrical energy is supplied to the control circuit and to peripherals via the electrical conductors, or the energy storage means arranged in the pocket tool is rechargeable via the electrical conductors.

The invention further contemplates and discloses advantageous design variations for arranging the control circuit and at least one peripheral.

A further, independent solution to the problem as defined by the invention relates to another disclosed functional component. The benefit ensuing therefrom lies mainly in the fact that the first coupling component of the functional component serving for the connection to the other coupling component, comprises at the same time the bearing component, forming a pivot-mounted bearing site. The capability of the functional component of swiveling out of a receiving area in the housing of the pocket tool is therefore provided via the first coupling component, and the functional component can be released from the housing of the pocket tool in its swiveled-out condition.

BRIEF DESCRIPTION OF THE DRAWINGS

The invention is explained in greater detail in the following with the help of the exemplified embodiments shown in the drawings, in which:

FIGS. 1 and 2 show perspective views of the pocket knife as defined by the invention, with an electronics module set to the storage position within the receiving area.

FIGS. 3 and 4 show perspective views of the pocket knife according to FIGS. 1 and 2, with the tools swiveled out, and the electronics module swiveled out into the position in which it is used.

FIG. 5 is a side view of the pocket knife according to FIG. 4.

FIG. 6 is a side view of the pocket knife according to FIG. 2.

FIG. 7 is a section along lines VII—VII in FIG. 6.

FIG. 8 is a perspective view of the pocket knife with the electronics module set to a removal position.

FIG. 9 is a side view of the pocket knife according to FIG. 8.

FIG. 10 shows an enlargement of a cutout of the pocket knife according to FIG. 9, with the pivot-mount arranged

between the support casing of the electronics module and the housing of the pocket knife, as well as its coupling device with a first design of the coupling components.

FIG. 11 is a perspective view of the closing cap for protecting the interface of the electronics module, the latter being fully pivoted into its storage position.

FIG. 12 is another side view and simplified representation of a coupling component of the coupling device of the pivot bearing.

FIG. 12a is a side view of a part section of the pocket knife with another design of a pivot bearing, and of a part section of the electronics module, the latter being inseparable from the housing.

FIG. 13 is a perspective view of the pocket knife, with the electronics module completely detached and separated from its casing.

FIG. 14 is a side view of the pocket knife and electronics module shown in a preliminary position prior to coupling it with the second coupling component of the housing.

FIG. 15 is a side view of a part section of the pocket knife and electronics module in a preliminary position prior to uncoupling it from the second coupling component of the housing.

FIG. 16 is a top view of a plate-like tool card shown by a highly simplified representation.

FIG. 17 is a highly simplified view of the tool card according to FIG. 16 according to lines XVII—XVII.

FIG. 18 is a longitudinal section and highly simplified representation of another possible design variation of a locking device disposed between the support casing of the electronics module and the housing of the tool card.

FIG. 19 is a perspective view of another design variation of the pocket knife with an electronics module comprising a control circuit and peripherals.

FIG. 20 is a side view of the electronics module according to FIG. 19.

FIG. 21 is a front view of the electronics module according to FIG. 19.

FIG. 22 shows a block diagram of the control circuit with different peripherals connected to said circuit.

FIG. 23 is a perspective view of another design variation of the pocket knife, with electronic components integrated in the housing.

FIG. 24 is a perspective view of another design variation of the pocket knife, with an electronics module detachable from the housing, and with electronic components arranged in the housing of the pocket tool.

FIG. 25 is a top view of a possible design variation of the pocket knife, with a plate-like electronics module.

FIG. 26 is a perspective view of another design variation of the pocket knife, with an external controlling unit for controlling the control circuit, and an external data medium.

FIG. 27 is a perspective view of yet another design variation of the pocket knife, with a plurality of electronics modules equipped in different ways.

FIG. 28 is a perspective view of yet another design variation of the pocket knife, with input/output devices provided on the cover plate; and

FIG. 29 is a perspective view of a possible design variation of a tool card comprising the electronics module.

DETAILED DESCRIPTION OF PREFERRED EMBODIMENTS

It is noted herewith by way of introduction that in the different embodiments described herein, identical components are provided with identical reference numerals and

-continued

LIST OF REFERENCE NUMERALS

70	Connection wall
71	Receiving slot
72	Detent nose
73	Locking device
74	Flange
75	Key ring
76	Narrow-side wall
77	Face side
78	Angle
79	Pivot bearing area
80	Bearing bore
81	Adapter
82	Plug socket
83	Arrow
84	Arrow
85	Arrow
86	Arrow
88	Depression
90	Tool card
91	Width
92	Length
93	Longitudinal side surface
94	Transverse side surface
95	Housing
96	Base plate
97	Cover plate
98	Side surface
99	Partition
100	Receiving area
101	Receiving opening
102	Knife
103	Multifunctional tool
105	Pincers
106	Phillips screwdriver
107	Toothpick
108	Handle
109	Rule
110	Longitudinal guide
111	Guide surface
112	Side surface
113	Detent nose
114	Detent deepening
115	Memory card
120	Control circuit
121	Peripheral
122	Storage element
123	Data interface
124	Input/output interface
125	Input/output device
126	Operating system
127	Energy supply system
128	Signal and/or data bus
129	Storage element
130	Longitudinal guide
131	Plug socket
132	Jack
133	Display
134	Input element
135	Key elements
136	Sliding key
137	Controller
138	Representation zone
139	Outside surface
140	Broad side
141	Narrow side
142	Face side
143	Module frame
144	Coupling device
145	Coupling element
146	Coupling element
147	Contact element
148	Contact element
149	Bus interface
150	Riveted pin
151	Operating unit
152	Transmission line
153	Loudspeaker

-continued

LIST OF REFERENCE NUMERALS

5	154	Mass storage
	155	Transmitter and/or receiver
	156	Connection system
	157	Snap arm
	158	Recess
10	159	Picture detection system
	160	Sound pick-up

What is claimed is:

1. A pocket tool, particularly a pocket knife or plate-like tool card, comprising a housing with at least one receiving area, and at least two functional components moveable from a storage position within the receiving area, into a working position outside of the receiving area, of which a first functional component is designed as a tool, particularly a pair of scissors, a knife or a utensil, in particular a toothpick, pincers, cleaning needle, writing pen, wherein a second functional component has a support casing and is equipped with a recordable and readable, nonvolatile memory, as well as an interface; and at least one releasable locking device and a longitudinal guide or a pivot bearing are arranged between the support bearing of the second functional component, and the housing.
2. The pocket tool according to claim 1, wherein the particularly oblong support casing of the second functional component comprises two parallel broad-side walls opposing one another; two parallel narrow-side walls extending substantially vertically between the broad-side walls and opposing one another; as well as two narrow-side walls opposing each other on the face side; and the memory is arranged within the support casing and the interface on one of the narrow-side walls on the face side.
3. The pocket tool according to claim 1, wherein the second functional component has only a part of the length of the housing.
4. The pocket tool according to claim 1, wherein the second functional component is adapted to pivot.
5. The pocket tool according to claim 1, wherein the second functional component is extractable.
6. The pocket tool according to claim 1, wherein the second functional component is separable from the housing.
7. The pocket tool according to claim 1, wherein the pivot bearing is equipped with a coupling device comprising coupling components engageable with and releasable from each other, whereby the support casing is provided with the first coupling component in one of its end areas, and the housing with the second coupling component in one of its face-side end areas.
8. The pocket tool according to claim 7, wherein the second coupling component is formed by a bearing axle, particularly a connection pin immovably arranged in the housing and extending perpendicular to the broad-side walls of the support casing.
9. The pocket tool according to claim 7, wherein the second coupling component is formed by an adapter pivot-mounted on the bearing axle immovably arranged in the housing and extending perpendicular to the broad-side walls of the support casing.
10. The pocket tool according to claim 9, wherein the adapter and the support casing each have at least one plug or detent or snap element; and that the second functional component is releasably connected with the adapter via a plug or detent or snap connection.

What is claimed is:

15 1. A pocket tool, particularly a pocket knife or plate-like tool card, comprising a housing with at least one receiving area, and at least two functional components moveable from a storage position within the receiving area, into a working position outside of the receiving area, of which a first functional component is designed as a tool, particularly a pair of scissors, a knife or a utensil, in particular a toothpick,
20 pincers, cleaning needle, writing pen, wherein a second functional component has a support casing and is equipped with a recordable and readable, nonvolatile memory, as well as an interface; and at least one releasable locking device and a longitudinal guide or a pivot bearing are arranged
25 between the support bearing of the second functional component, and the housing.

30 2. The pocket tool according to claim 1, wherein the particularly oblong support casing of the second functional component comprises two parallel broad-side walls opposing one another; two parallel narrow-side walls extending substantially vertically between the broad-side walls and opposing one another; as well as two narrow-side walls opposing each other on the face side; and the memory is
35 arranged within the support casing and the interface on one of the narrow-side walls on the face side.

3. The pocket tool according to claim 1, wherein the second functional component has only a part of the length of the housing.

Propriedade Intelectual em sua várias dimensões, com destaque a patentes



- O que é patente
- O que é patenteável
- O que não é patenteável
- Como é um documento de patente
- **Como definir o escopo de proteção de uma patente**
- Como é o processo de patenteamento

CAPÍTULO V

DA PROTEÇÃO CONFERIDA PELA PATENTE

Seção I

Dos Direitos

Art. 41. A extensão da proteção conferida pela patente será determinada pelo teor das reivindicações, interpretado com base no relatório descritivo e nos desenhos.

Art. 42. A patente confere ao seu titular o direito de impedir terceiro, sem o seu consentimento, de produzir, usar, colocar à venda, vender ou importar com estes propósitos:

I - produto objeto de patente;

II - processo ou produto obtido diretamente por processo patenteado.

§ 1º Ao titular da patente é assegurado ainda o direito de impedir que terceiros contribuam para que outros pratiquem os atos referidos neste artigo.



Como definir a extensão da cobertura de uma patente - Interpretação

... caracterizado por: **A & B & C**

- Protege: ... & **A & B & C**
... & A & **B & C** & **D**
... & **A & B & C**
- Não Protege: ... & (**A & B**) ã **C**

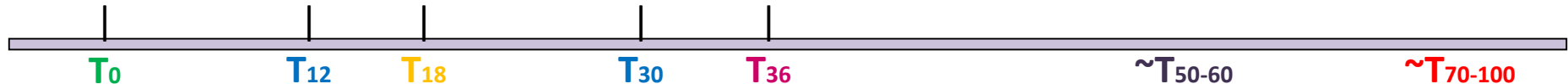
Propriedade Intelectual em sua várias dimensões, com destaque a patentes



- O que é patente
- O que é patenteável
- O que não é patenteável
- Como é um documento de patente
- Como definir o escopo de proteção
- Como é o processo de patenteamento

Como é o processo de patenteamento

- Busca prévia (estado da técnica)
- Definição do escopo da invenção, redação do pedido
- Depósito do primeiro pedido (T_0)
- Depósitos internacionais (T_{12} ou T_{30})
- Publicação dos pedidos até então depositados (T_{18})
- Pagamento da taxa para exame técnico pelo INPI (T_{20-36})
- Exame técnico / Adequação do pedido ($\sim T_{50-60}$)
- Deferimento do pedido
- Expedição da Carta Patente ($\sim T_{70-100}$)
- Nulidade administrativa ou judicial



Como é o processo de patenteamento

- **Busca prévia (estado da técnica)**
- Definição do escopo da invenção, redação do pedido
- Depósito do primeiro pedido (T_0)
- Depósitos internacionais (T_{12} ou T_{30})
- Publicação dos pedidos até então depositados (T_{18})
- Pagamento da taxa para exame técnico pelo INPI (T_{20-36})
- Exame técnico / Adequação do pedido ($\sim T_{50-60}$)
- Deferimento do pedido
- Expedição da Carta Patente ($\sim T_{70-100}$)
- Nulidade administrativa ou judicial



T_0

Como é o processo de patenteamento

- Busca prévia (estado da técnica)
- **Definição do escopo da invenção, redação do pedido**
- Depósito do primeiro pedido (T_0)
- Depósitos internacionais (T_{12} ou T_{30})
- Publicação dos pedidos até então depositados (T_{18})
- Pagamento da taxa para exame técnico pelo INPI (T_{20-36})
- Exame técnico / Adequação do pedido ($\sim T_{50-60}$)
- Deferimento do pedido
- Expedição da Carta Patente ($\sim T_{70-100}$)
- Nulidade administrativa ou judicial



T_0

Como é o processo de patenteamento

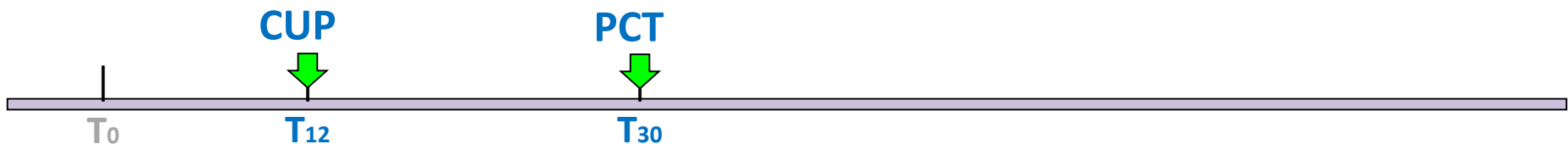
- Busca prévia (estado da técnica)
- Definição do escopo da invenção, redação do pedido
- **Depósito do primeiro pedido (T_0)**
- Depósitos internacionais (T_{12} ou T_{30})
- Publicação dos pedidos até então depositados (T_{18})
- Pagamento da taxa para exame técnico pelo INPI (T_{20-36})
- Exame técnico / Adequação do pedido ($\sim T_{50-60}$)
- Deferimento do pedido
- Expedição da Carta Patente ($\sim T_{70-100}$)
- Nulidade administrativa ou judicial



T_0

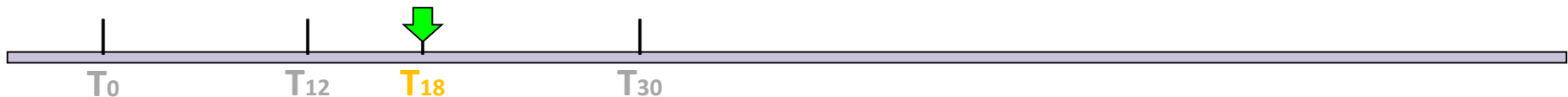
Como é o processo de patenteamento

- Busca prévia (estado da técnica)
- Definição do escopo da invenção, redação do pedido
- Depósito do primeiro pedido (T_0)
- **Depósitos internacionais (T_{12} ou T_{30})**
- Publicação dos pedidos até então depositados (T_{18})
- Pagamento da taxa para exame técnico pelo INPI (T_{20-36})
- Exame técnico / Adequação do pedido ($\sim T_{50-60}$)
- Deferimento do pedido
- Expedição da Carta Patente ($\sim T_{70-100}$)
- Nulidade administrativa ou judicial



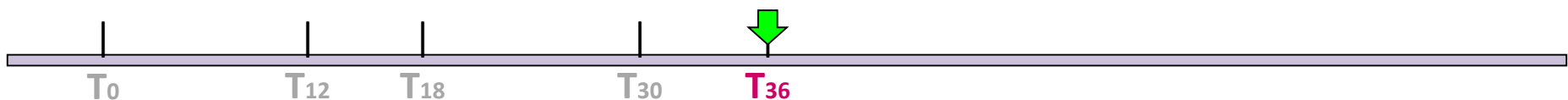
Como é o processo de patenteamento

- Busca prévia (estado da técnica)
- Definição do escopo da invenção, redação do pedido
- Depósito do primeiro pedido (T_0)
- Depósitos internacionais (T_{12} ou T_{30})
- **Publicação dos pedidos até então depositados (T_{18})**
- Pagamento da taxa para exame técnico pelo INPI (T_{20-36})
- Exame técnico / Adequação do pedido ($\sim T_{50-60}$)
- Deferimento do pedido
- Expedição da Carta Patente ($\sim T_{70-100}$)
- Nulidade administrativa ou judicial



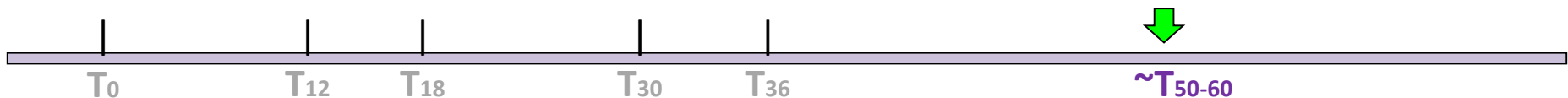
Como é o processo de patenteamento

- Busca prévia (estado da técnica)
- Definição do escopo da invenção, redação do pedido
- Depósito do primeiro pedido (T_0)
- Depósitos internacionais (T_{12} ou T_{30})
- Publicação dos pedidos até então depositados (T_{18})
- **Pagamento da taxa para exame técnico pelo INPI (T_{20-36})**
- Exame técnico / Adequação do pedido ($\sim T_{50-60}$)
- Deferimento do pedido
- Expedição da Carta Patente ($\sim T_{70-100}$)
- Nulidade administrativa ou judicial



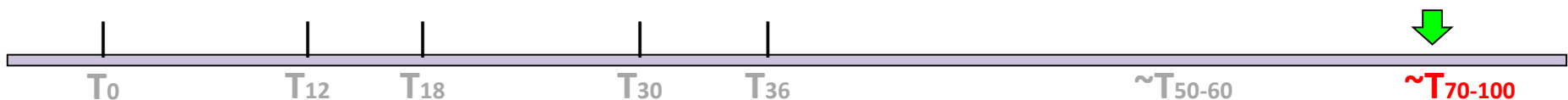
Como é o processo de patenteamento

- Busca prévia (estado da técnica)
- Definição do escopo da invenção, redação do pedido
- Depósito do primeiro pedido (T_0)
- Depósitos internacionais (T_{12} ou T_{30})
- Publicação dos pedidos até então depositados (T_{18})
- Pagamento da taxa para exame técnico pelo INPI (T_{20-36})
- **Exame técnico / Adequação do pedido ($\sim T_{50-60}$)**
- Deferimento do pedido
- Expedição da Carta Patente ($\sim T_{70-100}$)
- Nulidade administrativa ou judicial



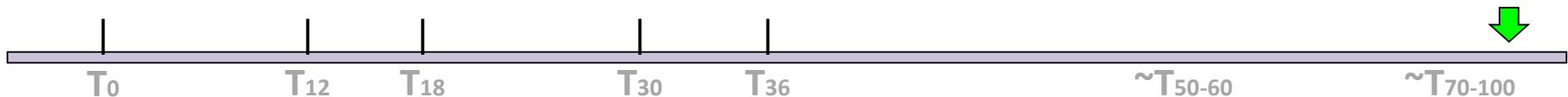
Como é o processo de patenteamento

- Busca prévia (estado da técnica)
- Definição do escopo da invenção, redação do pedido
- Depósito do primeiro pedido (T_0)
- Depósitos internacionais (T_{12} ou T_{30})
- Publicação dos pedidos até então depositados (T_{18})
- Pagamento da taxa para exame técnico pelo INPI (T_{20-36})
- Exame técnico / Adequação do pedido ($\sim T_{50-60}$)
- **Deferimento do pedido**
- **Expedição da Carta Patente ($\sim T_{70-100}$)**
- Nulidade administrativa ou judicial



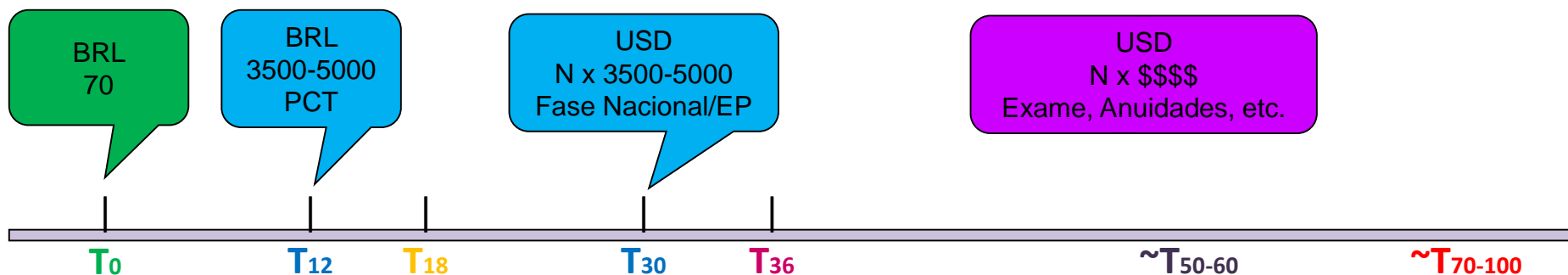
Como é o processo de patenteamento

- Busca prévia (estado da técnica)
- Definição do escopo da invenção, redação do pedido
- Depósito do primeiro pedido (T_0)
- Depósitos internacionais (T_{12} ou T_{30})
- Publicação dos pedidos até então depositados (T_{18})
- Pagamento da taxa para exame técnico pelo INPI (T_{20-36})
- Exame técnico / Adequação do pedido ($\sim T_{50-60}$)
- Deferimento do pedido
- Expedição da Carta Patente ($\sim T_{70-100}$)
- **Nulidade administrativa ou judicial**



Como é o processo de patenteamento

- Busca prévia (estado da técnica)
- Definição do escopo da invenção, redação do pedido
- Depósito do primeiro pedido (T_0)
- Depósitos internacionais (T_{12} ou T_{30})
- Publicação dos pedidos até então depositados (T_{18})
- Pagamento da taxa para exame técnico pelo INPI (T_{20-36})
- Exame técnico / Adequação do pedido ($\sim T_{50-60}$)
- Deferimento do pedido
- Expedição da Carta Patente ($\sim T_{70-100}$)
- Nulidade administrativa ou judicial





Uso Estratégico de Propriedade Intelectual e Informações Tecnológicas

Foco no Setor Farmacêutico

- Agenda

- Propriedade Intelectual no contexto farmacêutico, com destaque a patentes

- **Uso estratégico de patentes e informações patentárias**

- Ferramentas e técnicas de busca e análise de informações tecnológicas

- Fontes, sistemas de busca e análise de informações com foco na área farmacêutica

- Exemplo de mapeamento de segmento tecnológico



Uso estratégico de patentes e informações patentárias

- Estudos de patenteabilidade e (in)validade
- Estudos de liberdade de comercialização
- Mapeamento de segmentos tecnológicos
- Invenção estratégica
- Patenteamento estratégico
- Monitoramento de concorrentes
- Identificação e caracterização de parceiros
- Etc.



Uso estratégico de patentes e informações patentárias

- Estudos de patenteabilidade e (in)validade

- Estudos

TUDO TORNADO ACESSÍVEL AO PÚBLICO

- Mapeamento de segmentos tecnológicos

- Invenção

POR QUALQUER MEIO

- Patenteabilidade

EM QUALQUER LUGAR

- Monitoramento de atividades

- Identificação

ANTES DA DATA DE PRIORIDADE, COM ALGUMAS EXCEÇÕES

- Etc.

Uso estratégico de patentes e informações patentárias

- Estudos de patenteabilidade e (in)validade
- Estudos de liberdade de comercialização

- Mapeamento

TODAS AS PATENTES

- Invenções

SOBRE TODOS OS COMPONENTES

- Patenteabilidade

- Monitoramento

- Identificação

EM TODOS OS TERRITÓRIOS ALVOS

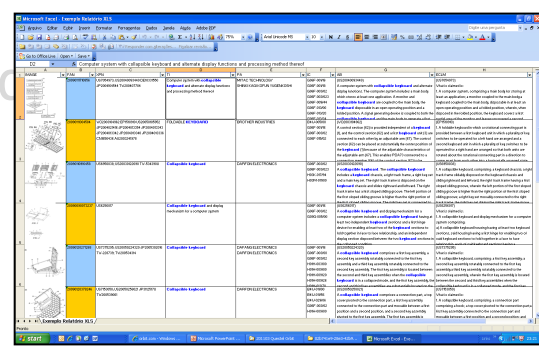
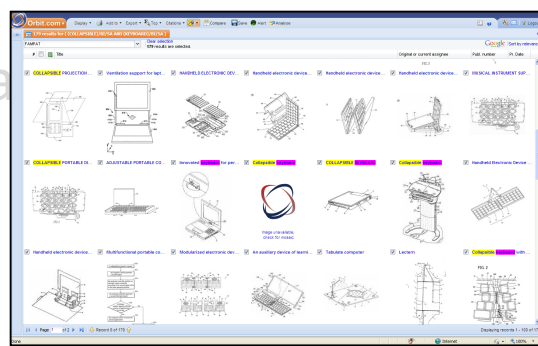
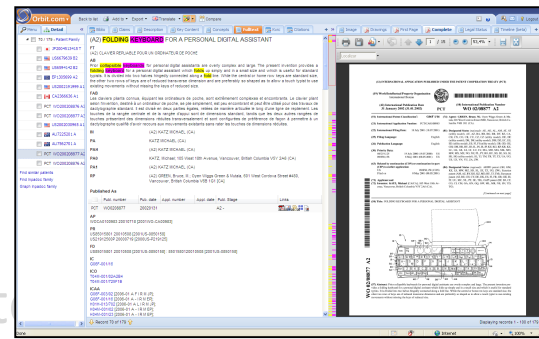
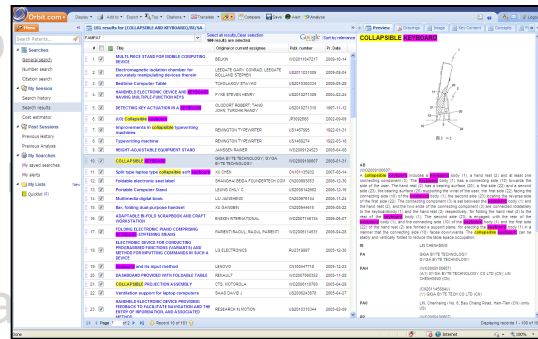
- Etc.

Uso estratégico de patentes e informações patentárias

- Estudos de patenteabilidade e (in)validade
- Estudos de liberdade de comercialização
- Mapeamento de segmentos tecnológicos

O que?

- Invenção
- Patenteabilidade
- Monitoramento
- Identificação
- Etc.



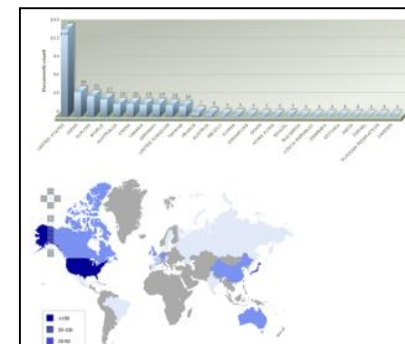
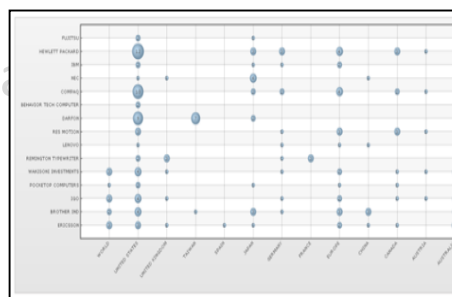
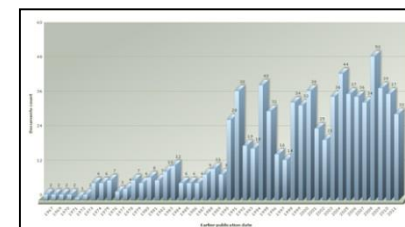
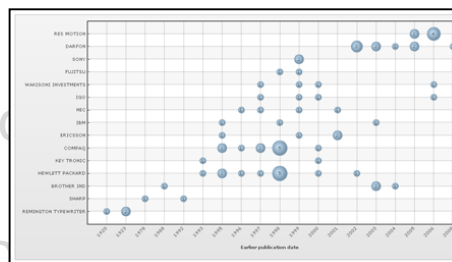
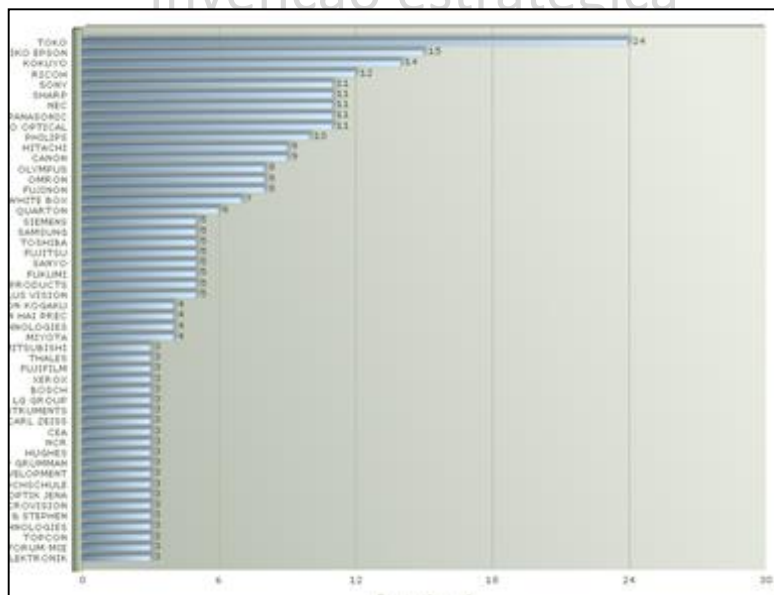
Uso estratégico de patentes e informações patentárias

- Estudos de patenteabilidade e (in)validade
- Estudos de liberdade de comercialização
- Mapeamento de segmentos tecnológicos
- Invenção estratégica

Quem ?

Quando?

Onde?

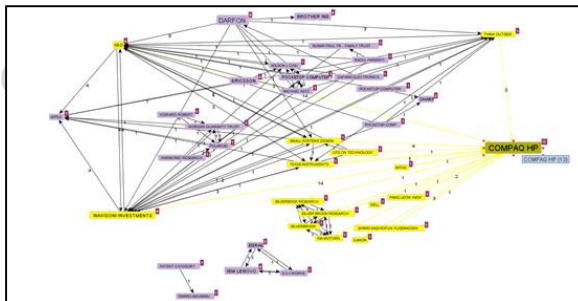
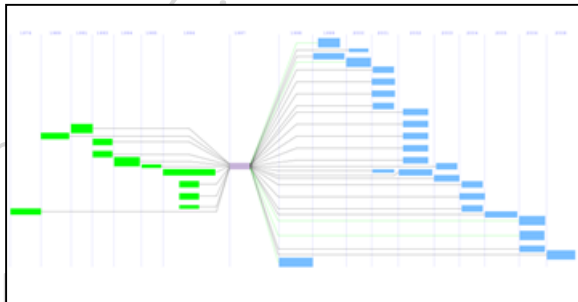


Uso estratégico de patentes e informações patentárias

- Estudos de patenteabilidade e (in)validade
- Estudos de liberdade de comercialização
- Mapeamento de segmentos tecnológicos

Como?

- Invenção
- Patentear
- Monitorar
- Identificar
- Etc.

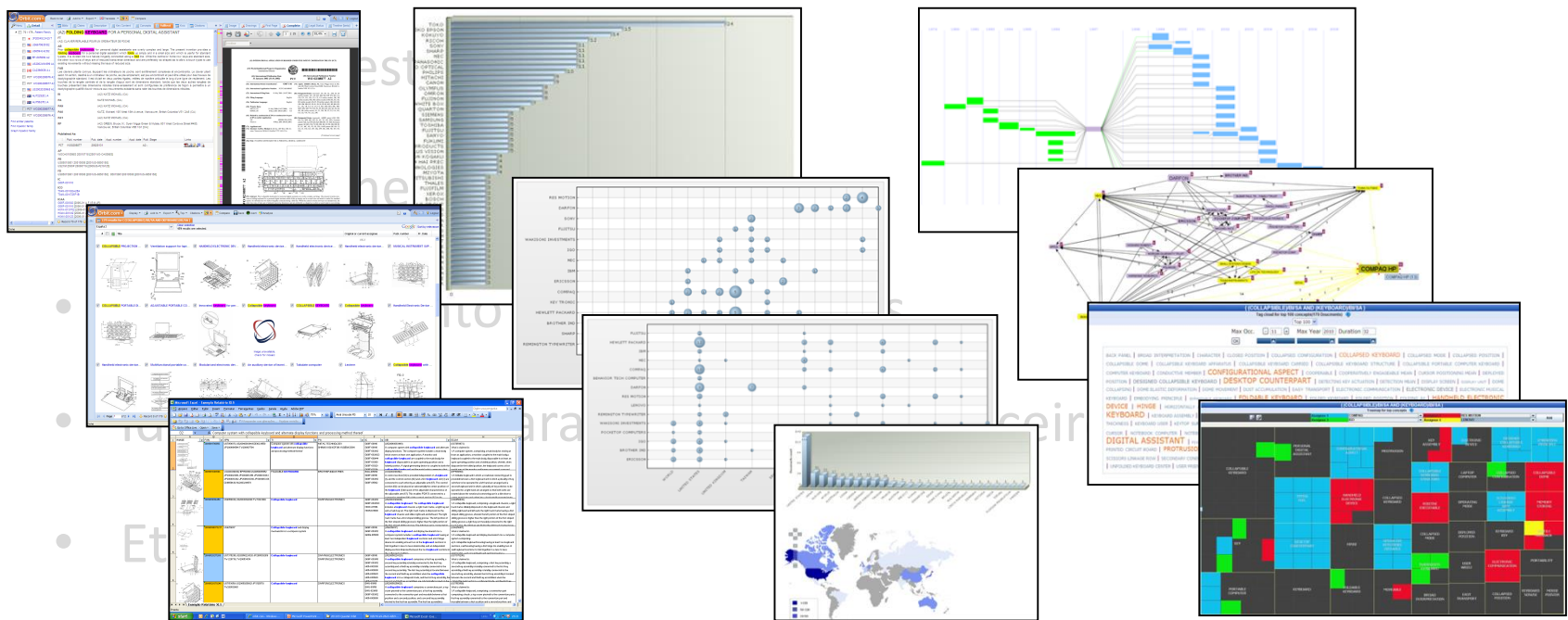


Uso estratégico de patentes e informações patentárias

- Estudos de patenteabilidade e (in)validade
- Estudos de liberdade de comercialização
- Mapeamento de segmentos tecnológicos

Por quê?

E daí ?



Uso estratégico de patentes e informações patentárias

- Estudos de patenteabilidade e (in)validade
- Estudos de liberdade de comercialização
- Mapeamento de segmentos tecnológicos

Por quê?

E daí ?

Leis e regulamentações

Acesso a Materiais

Canais de Distribuição

Recursos Financeiros

Etc...

Patentes

Literatura Técnica e Científica

Dados de Mercado

Experts





Uso estratégico de patentes e informações patentárias

- Estudos de patenteabilidade e (in)validade
- Estudos de liberdade de invenção
- Mapeamento de patentes
- Invenção estratégica

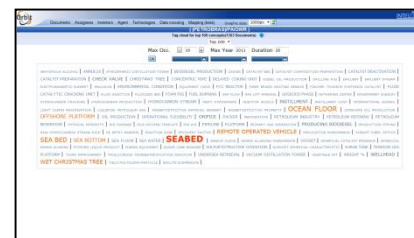
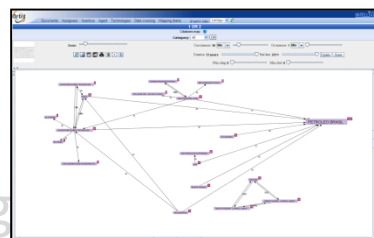
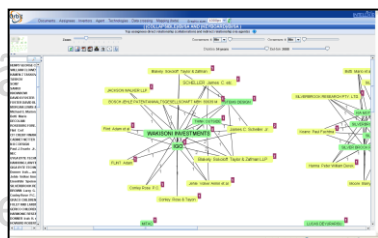
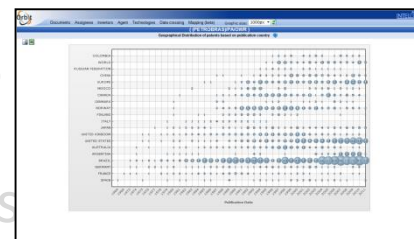
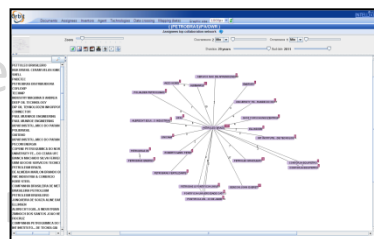
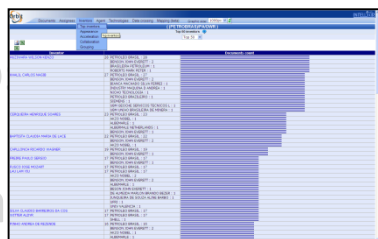
tenha em mente que o “jogo” de patentes é praticado com e contra outros jogadores

- Patenteamento estratégico
- Monitoramento de patentes
- Identificação de oportunidades
- Etc.

acompanhe e se antecipe a movimentos de concorrentes e entrantes

Uso estratégico de patentes e informações patentárias

- Estudos de patenteabilidade e (in)validade



- Estudo de validade de patentes
- Mapeamento de tecnologias
- Invenções
- Patentes estratégicas

- Monitoramento de concorrentes
- Identificação e caracterização de parceiros
- Etc.

Uso estratégico de patentes e informações patentárias

- Estudos de patenteabilidade e (in)validade
- Estudos de liberdade de
- Mapeamento de segmentos
- **Invenção estratégica**
- Patenteamento estratégico
- Monitoramento de concorrentes
- Identificação e caracterização
- Etc.

conheça o que já existe,
as barreiras de entrada
e o mercado
antes de sair inventando

anteveja
possíveis cenários futuros
para direcionar esforços

Exemplo de Caso

Advanced search

Keywords

Title, Abstract

BUILDING BLOCK? 5D BOTTLE CAP?



E.g.:Telecom+ OR phone



Title, Abstract, Claims, Description, C



Classifications

Names

Numbers, dates & country

Legal status

More fields

Collections

Search Show cmd. line Create script Clear

Full Text merged in families (FamPat)

Search Step	Result(s)	Query	Assistant	Source	Action
1	9	(BUILDING BLOCK? 5D BOTTLE CAP?)/TI/AB/IW	Advanced search	FAMPAT	Show results Modify Save Alert Delete

Combine strategies, E.g.: (1 or 2) not 3, 1 and (phone+)

(BUILDING BLOCK? 5D BOTTLE CAP?)/TI/AB/IW

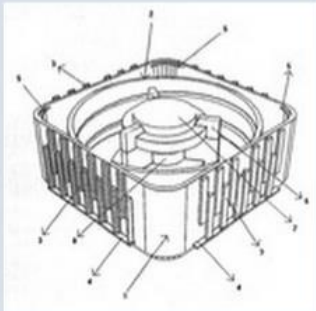
Search

9 results for (BUILDING BLOCK? 5D BOTTLE CAP?)/TI/AB/IW Collection: FAMPAT

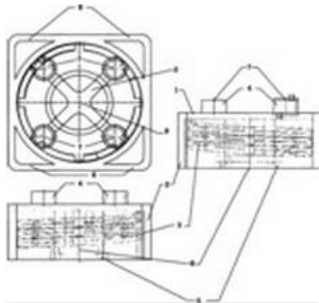
Select [Icons]

Fampat grouping Display [Icons]

RS



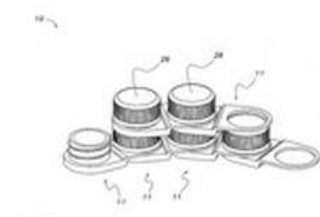
Magnetic bottle cap building...



Splicing magnetic bottle cap...



Bottle cap building block

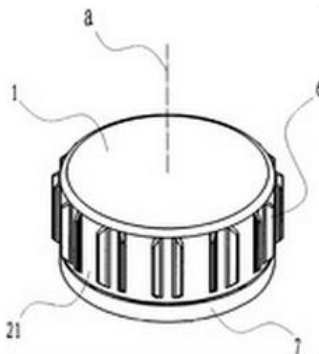


Building system using plasti...

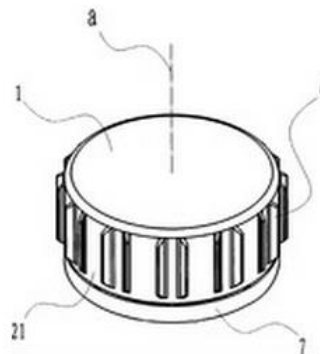


Image unavailable, check for mosaic

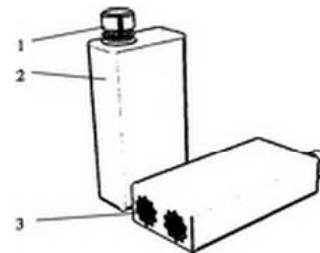
Bottle cap building block



A splicing bottle cap



Bottle cap capable of being ...



Building block bottle

9 results for (BUILDING BLOCK? 5D BOTTLE CAP?)/TI/AB/IW Collection: FAMPAT

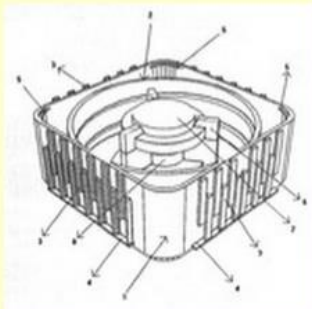
Select: 7

Fampat grouping Display

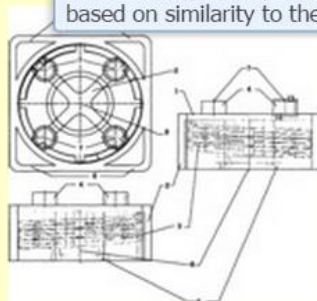
[checkbox] RS

More like this

Find similar patents, or rank and refine the results set based on similarity to the selected records



[checkbox] Magnetic bottle cap building...



[checkbox] Splicing magnetic bottle cap...



[checkbox] Bottle cap building block

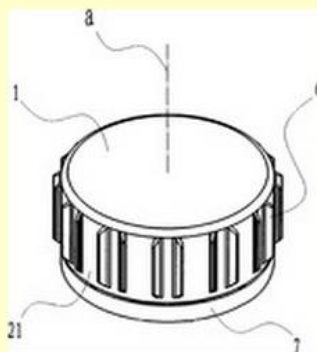


[checkbox] Building system using plasti...

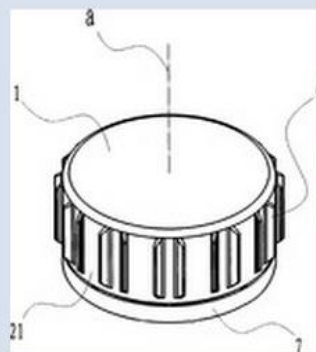


Image unavailable, check for mosaic

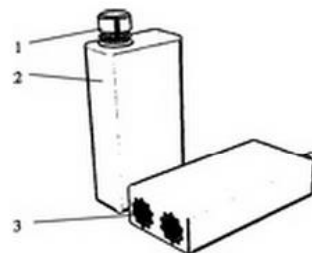
[checkbox] Bottle cap building block



[checkbox] A splicing bottle cap



[checkbox] Bottle cap capable of being ...



[checkbox] Building block bottle

26171 results for Similar patents Collection: FAMPAT



Fampat grouping Display

RS



Building system using plasti...

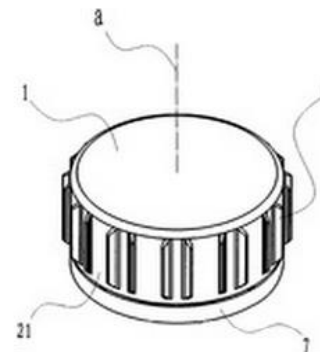


Bottle cap building block

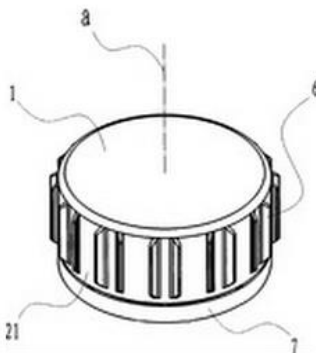


Image unavailable, check for mosaic

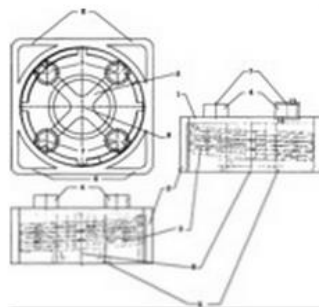
Bottle cap building block



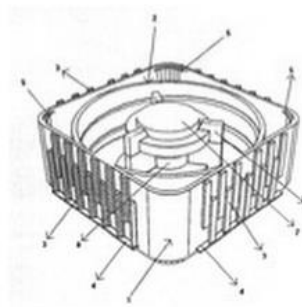
A splicing bottle cap



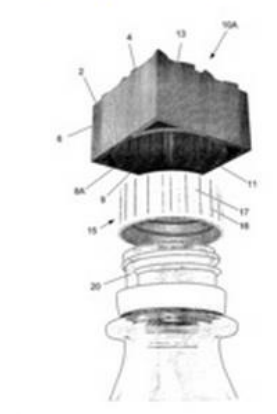
Bottle cap capable of being ...



Splicing magnetic bottle cap...



Magnetic bottle cap building...



Modular bottle closure



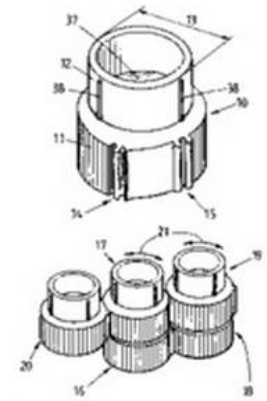
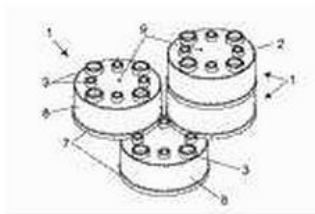
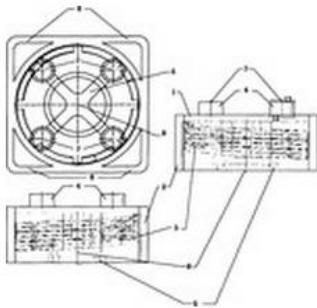
26171 results for Similar patents Collection: FAMPAT



Fampat grouping Display

RS

- Bottle cap capable of being ...
- Splicing magnetic bottle cap...
- Magnetic bottle cap building...
- Modular bottle closure



- Splicing-inserting magnetic ...
- Cap re-usable as interlockin...
- Toy utilizing used, discarda...
- A body for use in a toy set

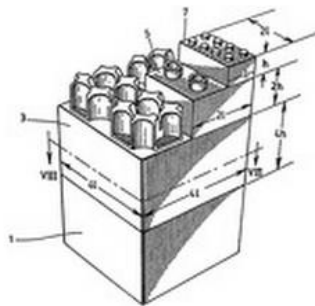
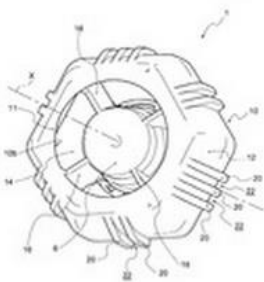
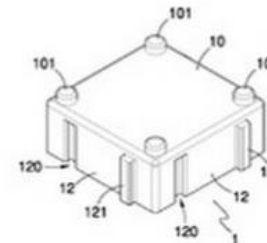
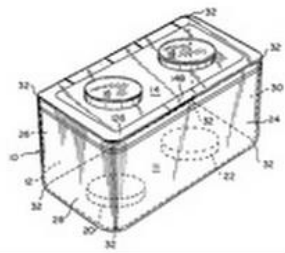
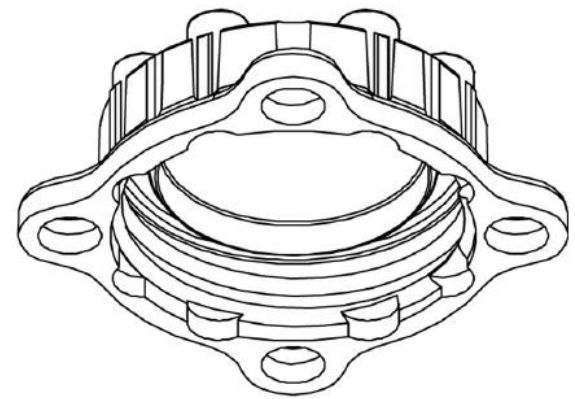
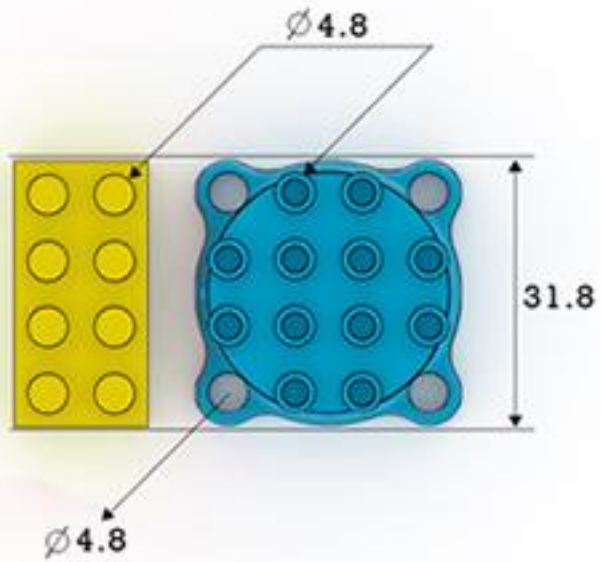


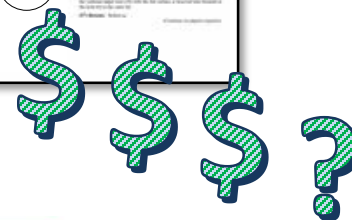
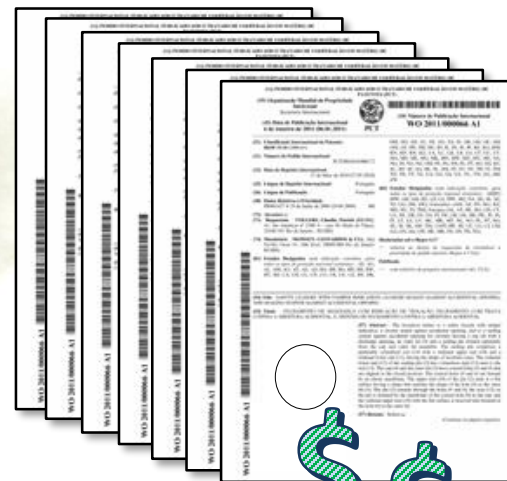
FIG. 1



- Cap for containers, for exam...
- Toy construction assembly
- Stackable container for pre...
- Bottle caps capable of being...

Fig. 5 (b)





DESIGN MUSEUM

DESIGNS OF THE YEAR 2014

Pelo
London Design Museum



if

IF Packaging Design Awards 2014

Premiado em duas categorias:
Categoria 01: Bebidas
Categoria 06: Formato da embalagem



23º prêmio
emb@news
 2014

Categoria:
 Sustentabilidade
DESTAQUE!





Uso Estratégico de Propriedade Intelectual e Informações Tecnológicas

Foco no Setor Farmacêutico

- Agenda

- Propriedade Intelectual no contexto farmacêutico, com destaque a patentes
- Uso estratégico de patentes e informações patentárias
- **Ferramentas e técnicas de busca e análise de informações tecnológicas**
- Fontes, sistemas de busca e análise de informações com foco na área farmacêutica
- Exemplo de mapeamento de segmento tecnológico

Pesquisa e Análise de Patentes

Ferramentas & Técnicas



- www.intellogist.com

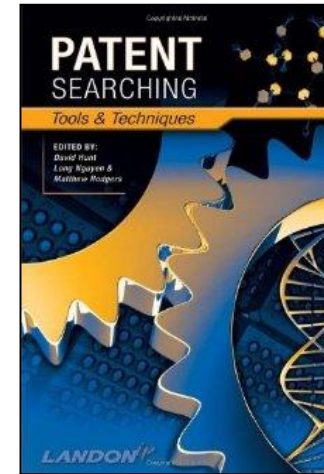
- www.piug.org

Pesquisa e Análise de Patentes

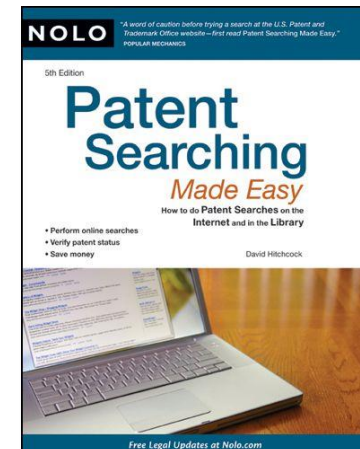
Ferramentas & Técnicas



- Patent Searching Tools & Techniques



- Patent Searching Made Easy





Pesquisa e Análise de Patentes

Ferramentas & Técnicas

• Palavras Chaves

- Título, Resumo, Relatório Descritivo, Reivindicações

• Campos Bibliográficos / Outros

- Titular (Assignee), Inventor
- Números de Prioridade, Depósito, Publicação
- Datas, Endereços, Representantes,
- Fórmulas Químicas, Biossequências, etc.

• Classificações de Patentes

- Internacional, Europeia, Norte Americana, Japonesa

• Citações

- Referências Citadas, / Citantes
- Pelo Titular / Pelo(s) Examinador(es)

• Famílias de Patentes

- Cobertura Geográfica
- Invenções Relacionadas

• Legal Status

- Concessão, Oposição, Abandono, Prolongamento, Etc

Pesquisa e Análise de Patentes

Ferramentas & Técnicas

Palavras Chaves

- Título, Resumo, Relatório Descritivo, Reivindicações

Campos Bibliográficos / Outros

- Titular (Assignee), Inventor
- Números de Prioridade, Depósito, Publicação
- Datas, Endereços, Representantes,
- Fórmulas Químicas, Biosoquências, Imagens, etc.

Classificações de Patentes

- Internacional, Europeia, Norte Americana, Japonesa

Citações

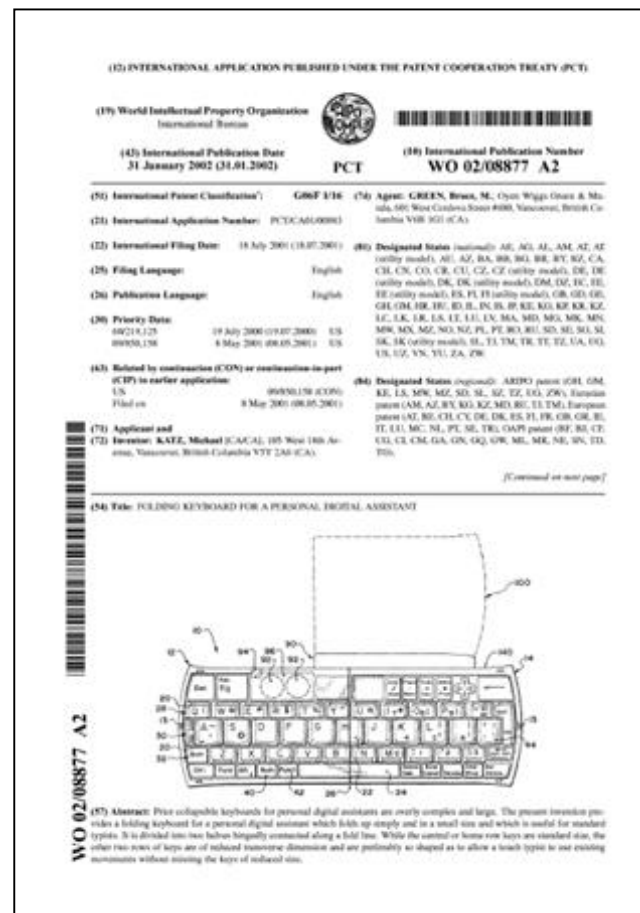
- Referências Citadas, / Citantes
- Pelo Titular / Pelo(s) Examinador(es)

Famílias de Patentes

- Cobertura Geográfica
- Invenções Relacionadas

Legal Status

- Concessão, Oposição, Abandono, Prolongamento, Etc



Pesquisa e Análise de Patentes

Ferramentas & Técnicas

• Palavras Chaves

- Título, Resumo, Relatório Descritivo, Reivindicações

• Outros campos

- Titular (Assignee), Inventor
- Números de Prioridade, Depósito, Publicação
- Datas, Endereços, Representantes,
- Fórmulas Químicas, Biossequências, Imagens, etc.

➔ • Classificações de Patentes

- Internacional, Europeia, Norte Americana, Japonesa

• Citações

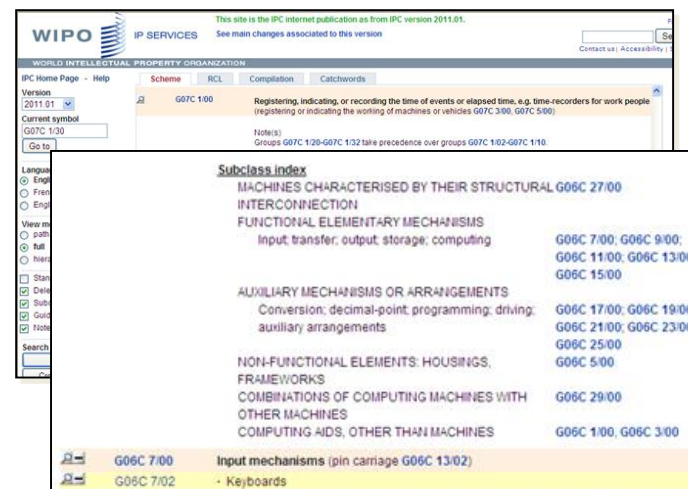
- Referências Citadas, / Citantes
- Pelo Titular / Pelo(s) Examinador(es)

• Famílias de Patentes

- Cobertura Geográfica
- Invenções Relacionadas

• Legal Status

- Concessão, Oposição, Abandono, Prolongamento, Etc



WIPO IP SERVICES

WORLD INTELLECTUAL PROPERTY ORGANIZATION

Version: 2011.01
Current symbol: G07C 1/30

Go to:

Language: Eng, Fre, Esp

View as: full, hier

Display: Def, Sub, Gui, Not

Search:

Subclass index

MACHINES CHARACTERISED BY THEIR STRUCTURAL INTERCONNECTION FUNCTIONAL ELEMENTARY MECHANISMS

Input transfer; output storage; computing	G06C 7/00; G06C 9/00; G06C 11/00; G06C 13/00; G06C 15/00
AUXILIARY MECHANISMS OR ARRANGEMENTS	
Conversion; decimal-point; programming; driving; auxiliary arrangements	G06C 17/00; G06C 19/00; G06C 21/00; G06C 23/00; G06C 25/00; G06C 5/00
NON-FUNCTIONAL ELEMENTS: HOUSINGS, FRAMEWORKS	
COMBINATIONS OF COMPUTING MACHINES WITH OTHER MACHINES	G06C 29/00
COMPUTING AIDS, OTHER THAN MACHINES	G06C 1/00; G06C 3/00

G06C 7/00 Input mechanisms (pin carriage G06C 13/02)

G06C 7/02 - Keyboards

G06C 7/02: Teclados (para computadores)

Pesquisa e Análise de Patentes

Ferramentas & Técnicas

• Palavras Chaves

- Título, Resumo, Relatório Descritivo, Reivindicações

• Outros campos

- Titular (Assignee), Inventor
- Números de Prioridade, Depósito, Publicação
- Datas, Endereços, Representantes,
- Fórmulas Químicas, Biossequências, Imagens, etc.

• Classificações de Patentes

- Internacional, Europeia, Norte Americana, Japonesa

• Citações

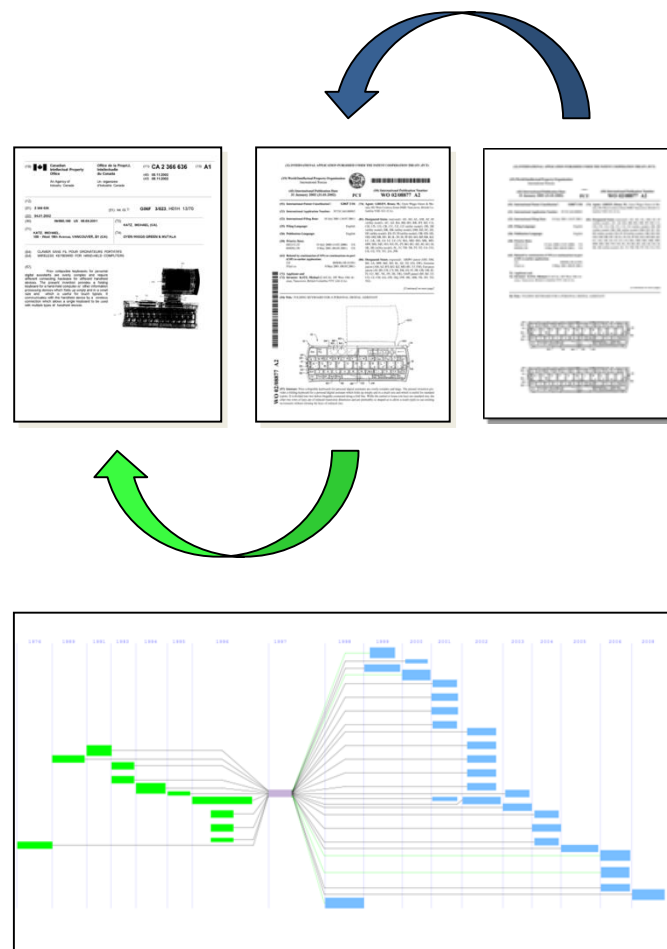
- Referências Citadas, / Citantes
- Pelo Titular / Pelo(s) Examinador(es)

• Famílias de Patentes

- Cobertura Geográfica
- Invenções Relacionadas

• Legal Status

- Concessão, Oposição, Abandono, Prolongamento, Etc



Pesquisa e Análise de Patentes

Ferramentas & Técnicas

• Palavras Chaves

- Título, Resumo, Relatório Descritivo, Reivindicações

• Outros campos

- Titular (Assignee), Inventor
- Números de Prioridade, Depósito, Publicação
- Datas, Endereços, Representantes,
- Fórmulas Químicas, Biossequências, Imagens, etc.

• Classificações de Patentes

- Internacional, Europeia, Norte Americana, Japonesa

• Citações

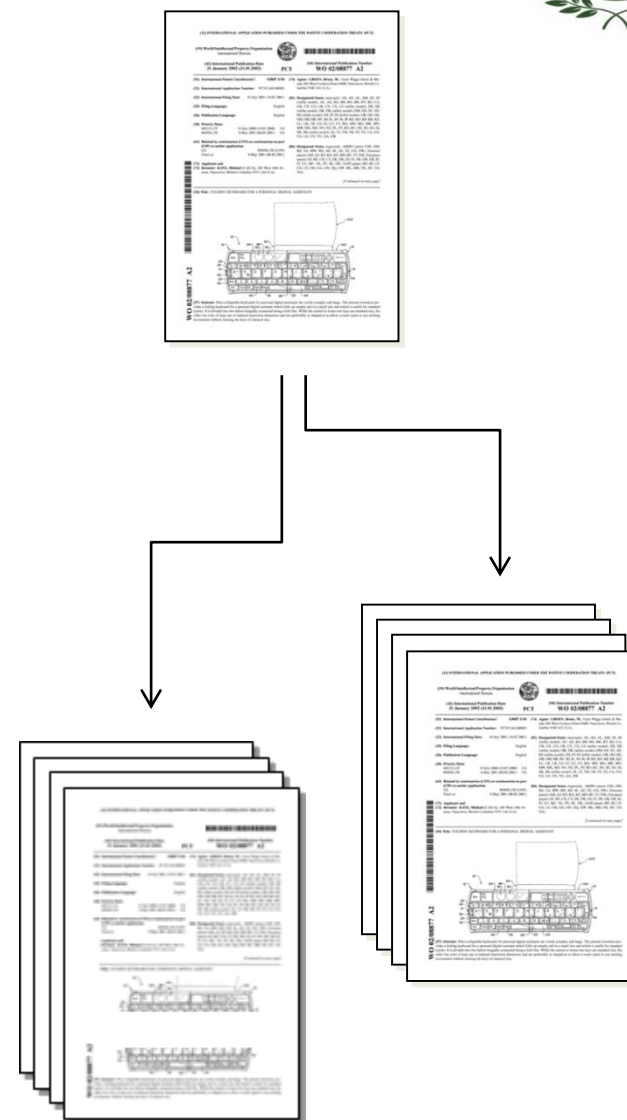
- Referências Citadas, / Citantes
- Pelo Titular / Pelo(s) Examinador(es)

➔ • Famílias de Patentes

- Cobertura Geográfica
- Invenções Relacionadas

• Legal Status

- Concessão, Oposição, Abandono, Prolongamento, Etc



Pesquisa e Análise de Patentes

Ferramentas & Técnicas

• Palavras Chaves

- Título, Resumo, Relatório Descritivo, Reivindicações

• Outros campos

- Titular (Assignee), Inventor
- Números de Prioridade, Depósito, Publicação
- Datas, Endereços, Representantes,
- Fórmulas Químicas, Biossequências, Imagens, etc.

• Classificações de Patentes

- Internacional, Europeia, Norte Americana, Japonesa

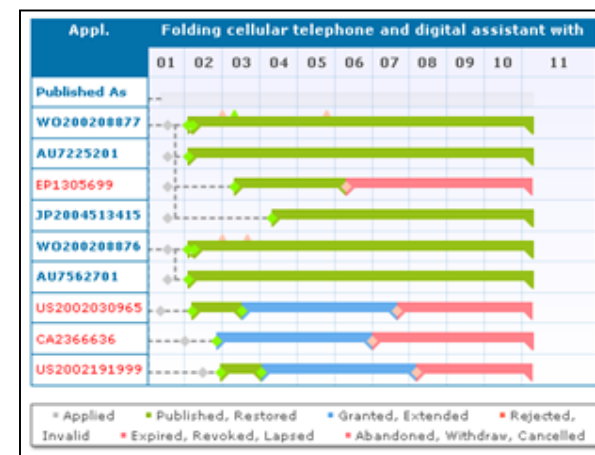
• Citações

- Referências Citadas, / Citantes
- Pelo Titular / Pelo(s) Examinador(es)

• Famílias de Patentes

- Cobertura Geográfica
- Invenções Relacionadas

Legal Status	
Dead: US2002030965 A1, US6594142 B2	
20010508 US/API [EXM;POS]	FLING DETAILS US65015801 20010508 [2001US-0850158]
20020314 US/A1 [EXM;POS]	First published patent application US2002030965 A1 20020314 [US2002030965]
20030715 US/B2 [PIF;POS]	Granted patent as second publication. US6594142 B2 20030715 [US6594142]
20070904 US/FP-A [NEG;NIF]	EXPIRED DUE TO FAILURE TO PAY MAINTENANCE FEEEFFECTIVE DATE: 20070715

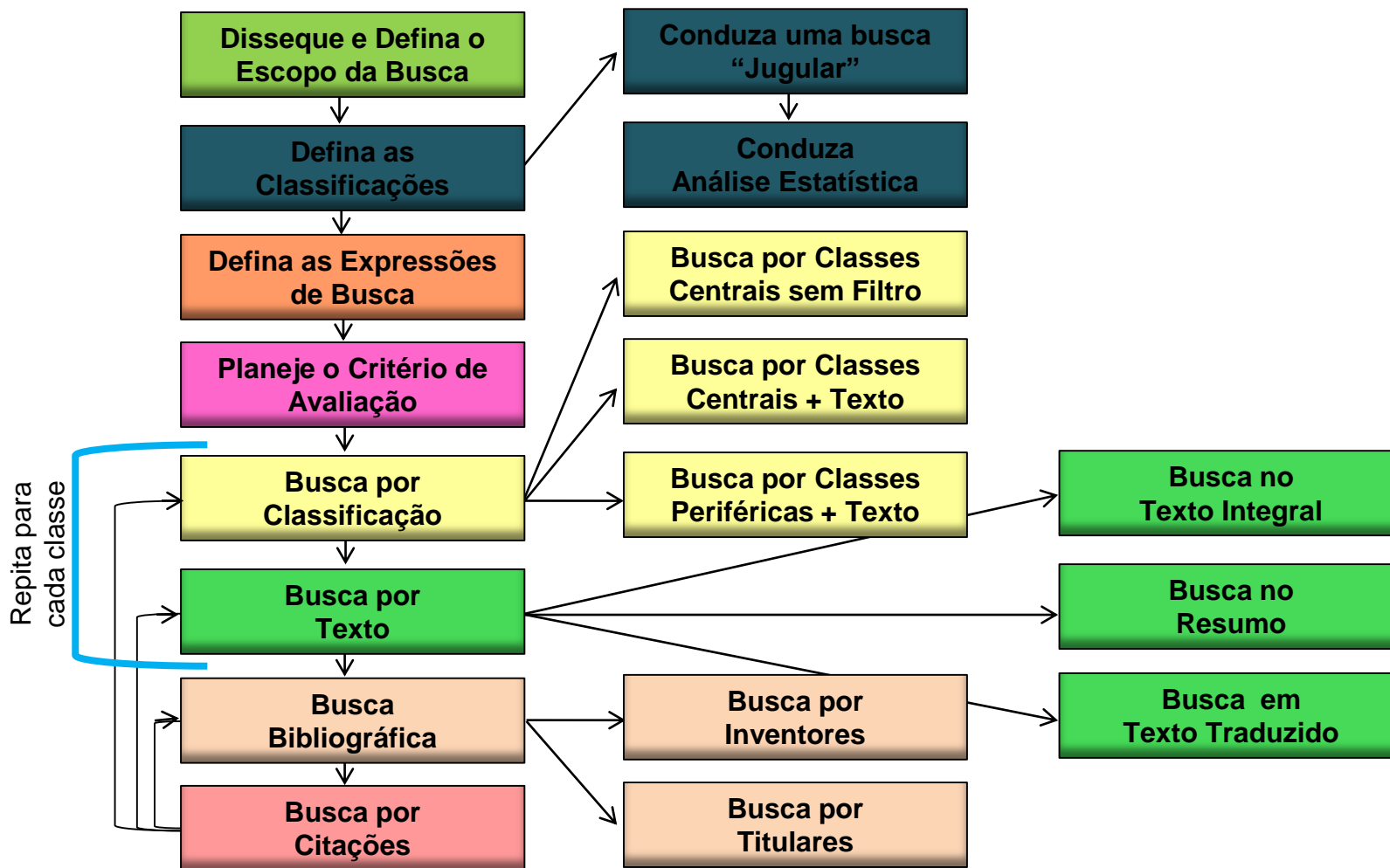


• Legal Status

- Concessão, Oposição, Abandono, Prolongamento, Etc

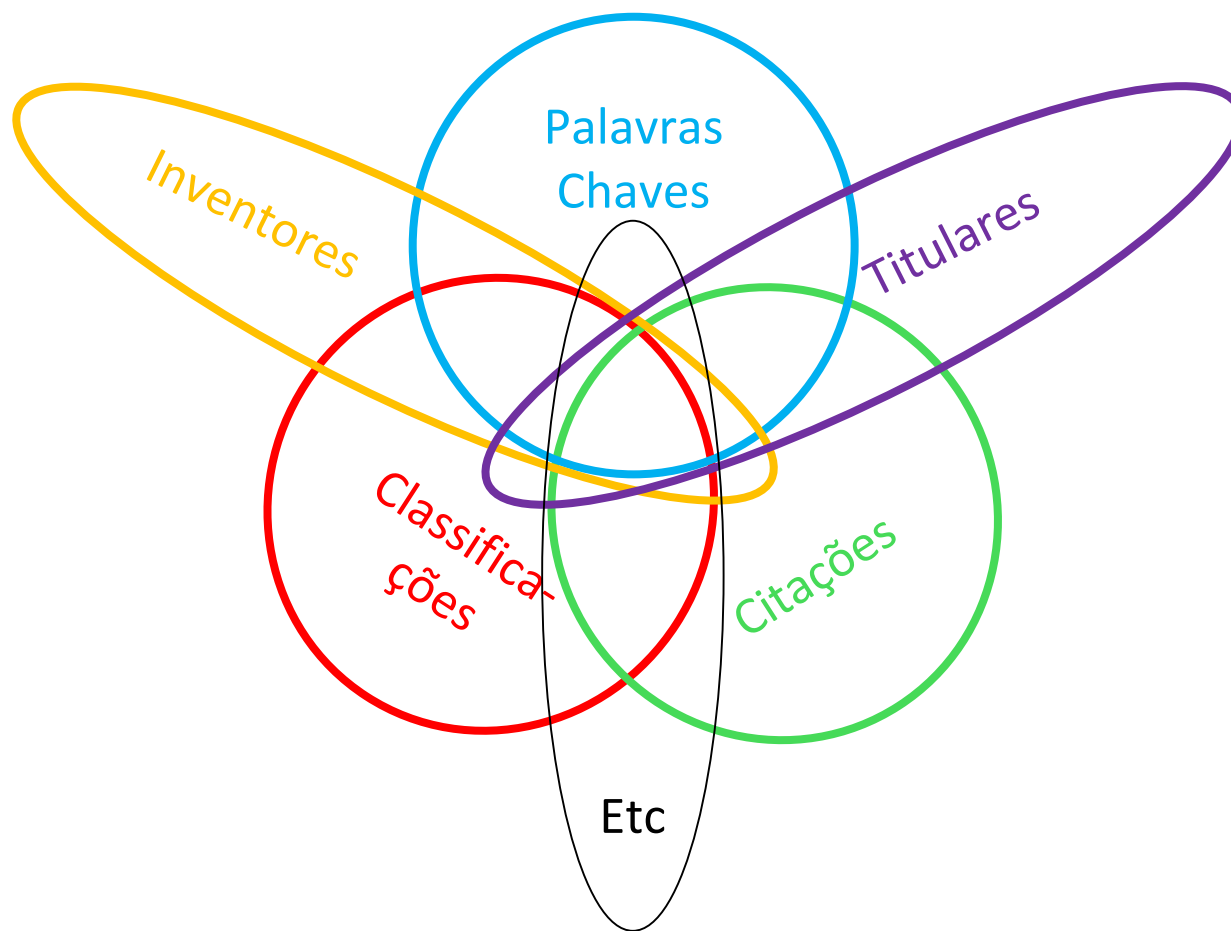
Pesquisa e Análise de Patentes

Exemplo de Roteiro de Busca



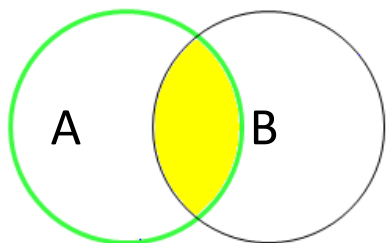
Pesquisa e Análise de Patentes

Exemplo de Roteiro de Busca

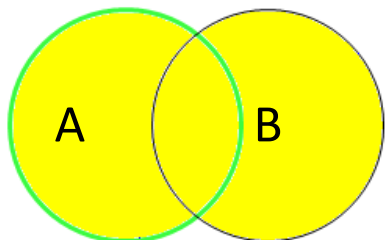


Buscas de Patentes

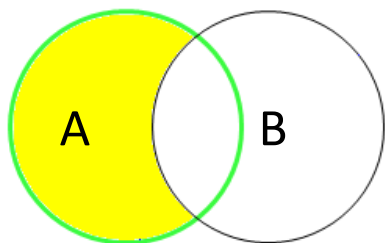
Operadores Booleanos



A and B (intersecção)



A or B (agrupamento)



A not B (exclusão*)

* Lembre-se de usar o NOT para encontrar o complemento. Ou seja, os resultados não contidos no conjunto anterior.



Buscas de Patentes

Operadores Booleanos e de Proximidade

AND	ambos os termos de busca presentes (intersecção)	digital and television
OR	um ou, opcionalmente, o outro termo de busca presente (soma, grupamento)	television or tv
NOT	o primeiro termo de busca presente, mas não o segundo (exclusão)	1 not 2
F	termos de busca no mesmo campo	digital f (televis+ or tv)
P	termos de busca no mesmo parágrafo	digital p (televis+ or tv)
S	termos de busca na mesma sentença	digital s (televis+ or tv)
nD	termos presentes, em qualquer ordem, de zero a n termos de distância (n de 1 a 99)	digital 5d (televis+ or tv)
D	termos contíguos, mas em qualquer ordem	digital d (televis+ or tv)
nW	termos presentes, na ordem digitada, de zero a n termos de distância (n de 1 a 99)	digital 5w (televis+ or tv)
W	termos contíguos, exatamente na ordem digitada	digital w (televis+ or tv)

Buscas de Patentes

Exemplos de Campos de Busca

Keywords

Title

- Title
- Title, Abstract
- Title, Abstract, Claims
- Title, Abstract, Key Content
- Title, Abstract, Key Content, Claims
- Claims
- Description
- Independent Claims
- Key Content
- Concepts
- Full Text

Restriction

Limit to the following legal status:

No restriction

- No restriction
- Patent in force
- Opposition
- Licensing
- Term right extended
- Ownership
- Entry into national phase
- Not in force

Names

Assignee (Original or Current)

- Assignee (Original or Current)
- Current Assignee
- Original Assignee

Classifications

IPC

- IPC
- ECLA
- ICO
- US (main)
- US (main & x-ref)
- FI
- F-Terms

Numbers, Dates & Country

Publ. number

- Publ. number
- Appl. number
- Priority number
- Application or Priority number

Abstracts

- Advantages over prior art drawbacks
- Object of invention
- Citations, all
- Citations, non patent References
- Designated States
- FamPat Family Number
- PCT Publication number
- PCT Application Nbr
- Patent Assignee Country
- Patent Assignee US State
- Inventor Country
- Inventor US State
- Representative Country
- US and FR Filing Details
- Other Publication Dates
- First Date of Pub.Appl.
- First Date of Issued Grant
- Patent Date, last pub.
- First Family's Priority Date
- EPO Dutch Class
- Number of Patents in the FamPat Family
- Number of Priorities in the FamPat Family
- USPTO Examiner or US Representative
- Independant claim number (US)
- Number of claims (US)
- Number of drawings (US)
- Number of figures (US)
- US Case ID
- Abstracts



Buscas de Patentes

Exemplos de Expressões de Busca

+prazol? or PPI or ((proton pump or hydrogen potassium ATPase or H K ATPase) (w) (inhib+))/bi or 73590-58-6/rn

... (5w) (pellet+ or +granul+ or +spher+)))/bi

... and BR/pn



Uso Estratégico de Propriedade Intelectual e Informações Tecnológicas

Foco no Setor Farmacêutico

- Agenda

- Propriedade Intelectual no contexto farmacêutico, com destaque a patentes
- Uso estratégico de patentes e informações patentárias
- Ferramentas e técnicas de busca e análise de informações tecnológicas
- **Fontes, sistemas de busca e análise de informações com foco na área farmacêutica**
- Exemplo de mapeamento de segmento tecnológico



Fontes de Informações Não Patentárias

- Internet aberta
ex: Google, Google Acadêmico, ClinicalTrials.gov, ICTRP*, etc.
- Bases de dados indexadas (literatura técnica)
ex. Caplus*, Medline, Embase*, Biosis, DDFU, Pascal, Kosmet, Napralert*, Scisearch, etc.
- Bases de dados sobre projetos de P&D, licenciamento, notícias, etc.
Ex. IMS New Product Focus*, IMS Research*, Adis R&D Insight, Biotechgate, MedTRACK, RoyaltySource, Chemical Business Newsbase* etc.
- Livros, Teses, Congressos, Conferências, Revisões
- Bulas e literatura de concorrentes
- Especialistas, Etc.



[Back to Search](#)

[Export results to XML](#)

72 records for 66 trials found for: yellow fever [\(What is this?\)](#)

Show records per page

1 2 3 4 5 6 7

Recruitment status	Main ID	Public Title	Date of Registration
Not recruiting	NCT02231853	Phase I/II Trial of Early Infusion of Multivirus Specific T Cells (MVST) to Prevent Post Transplant Viral Infections	03/09/2014
Authorised	EUCTR2014-001118-24-BE ⁽⁺⁾	Evaluation of the immunogenicity and safety of GlaxoSmithKline (GSK) Biologicals' Quadrivalent Influenza Vaccine Influxplit™ Tetra (Fluarix™ Tetra) (GSK2321138A) when co-administered with Pneumovax™ 23 in adults 50 years of age and older.	18/07/2014
Recruiting	NCT02103023	Intradermal Influenza Vaccine in the Young	28/03/2014
Not recruiting	NCT02072174	Clinical Trial of Efficacy of Anaferon for Children® in the Treatment of Influenza and Acute Respiratory Viral Infections in Children	14/02/2014
Recruiting	NCT02013934	Probiotics in Prevention of Common Cold	06/12/2013
Not recruiting	NCT02007356	A Study to Assess Safety and Feasibility of Direct Infusions of Donor-derived Virus-specific T-cells in Recipients of Hematopoietic Stem Cell Transplantation With Post-transplant Viral Infections Using the Cytokine Capture System®	26/11/2013
Not Recruiting	DRKS00005310	The role of monocytes at the infect defense after stem cell transplantation in children and young adults.	23/09/2013
Recruiting	NCT01943305	The Role of Pre-existing Cross-reactive Antibodies in Determining the Efficacy of Vaccination in Humans	03/09/2013
Not Recruiting	CTRI/2013/08/003919	TO EVALUATE EFFICACY AND SAFETY OF DNT -53 IN PATIENTS WITH LOW PLATELET COUNT.	23-08-2013
Not Recruiting	NTR4102	Prevalence, burden, and shedding patterns of respiratory viral infections on the ICU	20/08/2013

1 2 3 4 5 6 7

CAplusSM/HCplus/ZCAplus (Chemical Abstracts Plus)

Subject Coverage	<ul style="list-style-type: none"> Analytical chemistry Applied chemistry Biochemistry 	<ul style="list-style-type: none"> Chemical engineering Macromolecular chemistry Organic chemistry 																		
File Type	Bibliographic																			
Features	<p>Thesauri Classification Code (/CC), Company Name (/CO), Controlled Term (/CT), Cooperative Patent Classification (CPC), European Patent Classification (/ECLA), F-Term (/FTERM), ICO (in-computer-only) Classification (/ICO), International Patent Classifications (/IPC), National Patent Classifications Current (/NCL), National Patent Classifications Issue (/INCL), and Role (/RL)</p> <p>Alerts (SDIs) Daily (Monday-Friday), weekly (default), biweekly</p> <table border="0"> <tr> <td>CAS Registry Number Identifiers</td> <td><input checked="" type="checkbox"/></td> <td>Page Images</td> <td><input checked="" type="checkbox"/></td> <td>STN[®] AnaVist™</td> <td><input checked="" type="checkbox"/></td> </tr> <tr> <td>Keep & Share</td> <td><input checked="" type="checkbox"/></td> <td>SLART</td> <td><input checked="" type="checkbox"/></td> <td>STN Easy[®]</td> <td><input checked="" type="checkbox"/></td> </tr> <tr> <td>Learning Database</td> <td><input checked="" type="checkbox"/></td> <td>Structures</td> <td><input checked="" type="checkbox"/></td> <td>STN[®] Viewer™</td> <td><input checked="" type="checkbox"/></td> </tr> </table>		CAS Registry Number Identifiers	<input checked="" type="checkbox"/>	Page Images	<input checked="" type="checkbox"/>	STN[®] AnaVist™	<input checked="" type="checkbox"/>	Keep & Share	<input checked="" type="checkbox"/>	SLART	<input checked="" type="checkbox"/>	STN Easy[®]	<input checked="" type="checkbox"/>	Learning Database	<input checked="" type="checkbox"/>	Structures	<input checked="" type="checkbox"/>	STN[®] Viewer™	<input checked="" type="checkbox"/>
CAS Registry Number Identifiers	<input checked="" type="checkbox"/>	Page Images	<input checked="" type="checkbox"/>	STN[®] AnaVist™	<input checked="" type="checkbox"/>															
Keep & Share	<input checked="" type="checkbox"/>	SLART	<input checked="" type="checkbox"/>	STN Easy[®]	<input checked="" type="checkbox"/>															
Learning Database	<input checked="" type="checkbox"/>	Structures	<input checked="" type="checkbox"/>	STN[®] Viewer™	<input checked="" type="checkbox"/>															
Record Content	<ul style="list-style-type: none"> Bibliographic information and available abstracts Cited references for journals, conference proceedings, and basic patents from the US, EPO, WIPO, and German patent offices added to CAS databases since 1997 Patent examiner citations from British and French patents (2003-present), Canadian patents (2005-present), Japanese patents (2011-present), as well as nearly 300,000 patent records from 1982-2008 Citing references Legal status information for U.S. patents since 1980 Patent classifications: IPC, CPC, ECLA, ICO, NCL and FTERM 																			
File Size	More than 40.1 million records (9/2014)																			
Coverage	1907-present plus more than 180,000 pre-1907 records																			
Updates	Daily updates (more than 5000 records)																			
Language	English																			
Database Producer	Chemical Abstracts Service 2540 Olentangy River Road P.O. Box 3012 Columbus, Ohio 43210-0012 USA																			

Sources	<p>Journals: Over 10,000 journals are monitored. All articles, including biographical items, book reviews, editorials, errata, letters to the editor, news announcements, product reviews, meeting abstracts, and miscellaneous items, from nearly 1500 key chemical journals covered since 1994. Bibliographic information and available abstracts for the articles from key journals are added within 1 week of journal receipt. New bibliographic records are added daily.</p> <ul style="list-style-type: none"> • Patents • Conference proceedings • Electronic-only journals • Books • Dissertations • Reviews • Technical disclosures • Web pre-prints • Meeting abstracts 		
User Aids	<ul style="list-style-type: none"> • Training materials are available on the CAS website at www.cas.org • STNGUIDE 	<ul style="list-style-type: none"> • Online Helps (HELP DIRECTORY lists all help messages available) 	
Clusters	<ul style="list-style-type: none"> • 2ANAVIST • AEROTECH • AGRICULTURE • ALLBIB • AUTHORS • BIOSCIENCE • CASLINK • CASRNS • CHEMENG • CHEMISTRY 	<ul style="list-style-type: none"> • CORPSOURCE • ENGINEERING • ENVIRONMENT • FOOD • FORMULATIONS • FUELS • GEOSCIENCE • GOVREGS • HEALTH • MATERIALS 	<ul style="list-style-type: none"> • MEDICINE • METALS • PATENTS • PETROLEUM • PHARMACOLOGY • PHYSICS • POLYMERS • PV • SAFETY • TOXICOLOGY <p>STN Database Clusters information (PDF).</p>
Related Databases	<ul style="list-style-type: none"> • CA • LCA 		
Pricing	Enter HELP COST at an arrow prompt.		

Sample Records

DISPLAY ALL (Journal)

ANSWER 1 OF 1 CAPLUS COPYRIGHT 2013 ACS on STN

AN 2000:138202 CAPLUS [Full-text](#)

DN 132:221385

ED Entered STN: 01 Mar 2000

TI Production process for recombinant human angiostatin in *Pichia pastoris*

AU Lin, J.; Panigraphy, D.; Trinh, L. B.; Folkman, J.; Shiloach, J.

CS Department of Surgery, Children's Hospital and Harvard Medical School,
Boston, MA, 02115, USA

SO Journal of Industrial Microbiology & Biotechnology (2000), 24(1), 31-35
CODEN: JIMBFL; ISSN: 1367-5435

DOI 10.1038/sj.jim.2900766

PB Nature Publishing Group

DT Journal

LA English

CC 16-2 (Fermentation and Bioindustrial Chemistry)

AB A pilot-scale production method of recombinant human angiostatin, a 38-kD fragment of plasminogen which has been reported to have antiangiogenic activity, has been successfully established by expressing the protein in the methylotrophic yeast *Pichia pastoris*. The secreted protein inhibited cultured endothelial cell proliferation in vitro and Lewis lung carcinoma growth in mice. The fermentation process was carried out using an online methanol controller, administering methanol to the growing culture and keeping its concentration under 2 g L⁻¹. The fermentation lasted 90 h, of which 70 h were growth on methanol. During growth on methanol the culture volume increased 64%, from 7 L to 11.5 L, producing 200 mg angiostatin and 5 kg of biomass.

ST recombinant human angiostatin fermn *Pichia*

IT Fermentation

Komagataella pastoris

(production process for recombinant human angiostatin in *Pichia pastoris*)

IT 86090-08-6P, Angiostatin

RL: BMF (Bioindustrial manufacture); BIOL (Biological study); PREP

(Preparation)

(production process for recombinant human angiostatin in *Pichia pastoris*)

IT 67-56-1, Methanol, biological studies

RL: BSU (Biological study, unclassified); BIOL (Biological study)

(production process for recombinant human angiostatin in *Pichia pastoris*)

OSC.G 10 THERE ARE 10 CAPLUS RECORDS THAT CITE THIS RECORD (10 CITINGS)

UPOS.G Date last citing reference entered STN: 27 Feb 2012

OS.G CAPLUS 2012:181723; 2010:1328434; 2010:548903; 2009:1288101;
2009:637424; 2007:75901; 2005:702147; 2005:3368; 2003:236743;
2001:230866

RE.CNT 18 THERE ARE 18 CITED REFERENCES AVAILABLE FOR THIS RECORD

RE CITED REFERENCES

(1) Brierley, R; Ann NY Acad Sci 1990, V589, P350 CAPLUS

(2) Brierley, R; WO 9003431 International Patent (PCT) Application 1989 CAPLUS

(3) Chen, Y; Proc Biochem 1997, V32, P107

(4) Folkman, J; Proc Natl Acad Sci 1979, V76, P5217 MEDLINE

NAPRALERT

Subject Coverage	Natural product information including pharmacology, biological activity, taxonomic distribution, ethnomedicine, and chemistry of plant, microbial, and animal (including marine) extracts																		
File Type	Bibliographic																		
Features	<table border="0"> <tr> <td>CAS Registry Number Identifiers</td> <td><input checked="" type="checkbox"/></td> <td>Page Images</td> <td><input type="checkbox"/></td> <td>STN[®] AnaVist[™]</td> <td><input type="checkbox"/></td> </tr> <tr> <td>Keep & Share</td> <td><input type="checkbox"/></td> <td>SLART</td> <td><input checked="" type="checkbox"/></td> <td>STN Easy[®]</td> <td><input checked="" type="checkbox"/></td> </tr> <tr> <td>Learning Database</td> <td><input type="checkbox"/></td> <td>Structures</td> <td><input type="checkbox"/></td> <td>STN[®] Viewer[™]</td> <td><input type="checkbox"/></td> </tr> </table>	CAS Registry Number Identifiers	<input checked="" type="checkbox"/>	Page Images	<input type="checkbox"/>	STN [®] AnaVist [™]	<input type="checkbox"/>	Keep & Share	<input type="checkbox"/>	SLART	<input checked="" type="checkbox"/>	STN Easy[®]	<input checked="" type="checkbox"/>	Learning Database	<input type="checkbox"/>	Structures	<input type="checkbox"/>	STN [®] Viewer [™]	<input type="checkbox"/>
CAS Registry Number Identifiers	<input checked="" type="checkbox"/>	Page Images	<input type="checkbox"/>	STN [®] AnaVist [™]	<input type="checkbox"/>														
Keep & Share	<input type="checkbox"/>	SLART	<input checked="" type="checkbox"/>	STN Easy[®]	<input checked="" type="checkbox"/>														
Learning Database	<input type="checkbox"/>	Structures	<input type="checkbox"/>	STN [®] Viewer [™]	<input type="checkbox"/>														
Record Content	<ul style="list-style-type: none"> • NAPRALERT (NATURAL PRODUCTS ALERT) contains bibliographic and factual data on natural products, including information on the pharmacology, biological activity, taxonomic distribution, chemistry of plant, microbial, and animal (including marine) extracts as well as ethnomedicine use records. In addition, the database contains information on the chemistry and pharmacology of secondary metabolites that are derived from natural sources and that have known structure. • The records in this file contain bibliographic information and factual data on natural products, including CAS Registry Numbers for many chemical constituents. 																		
File Size	187,821 bibliographic records containing information for over 155,000 natural products and 181,895 organisms (07/2013)																		
Coverage	<ul style="list-style-type: none"> • 1650 to 2011 • Approximately 50% of the file is from systematic survey of the literature from 1975 to 2011. The remaining records were obtained by selective retrospective indexing dating back to 1650 																		
Updates	<ul style="list-style-type: none"> • Occasional updates as information becomes available • Automatic current-awareness searches (SDIs) are not available 																		
Language	English																		
Database Producer	Program for Collaborative Research in the Pharmaceutical Sciences College of Pharmacy University of Illinois at Chicago Chicago, Illinois 60680 USA Phone: 312-996-2246 Fax: 312-996-7107																		

NAPRALERT

Sample Records

DISPLAY IALL

ACCESSION NUMBER: 2012:7757 NAPRALERT
DOCUMENT NUMBER: L33123
TITLE: MUTAGENICITY OF FOUR NATURAL FLAVORS: CLOVE, CINNAMON, THYME
AND ZATARIA MULTIFLORA BOISS
AUTHOR: SHOEIBI S H; RAHIMIFARD N; PIROUZ B; YALFANI R; PAKZAD S R;
MIRAB S S; PIRALI H M
CORPORATE SOURCE: FOOD DRUG LAB RESEARCH CENTER, TEHRAN IRAN
SOURCE: J MED PLANTS (2009) 8 (5) p. 89-96.
DOCUMENT TYPE: Paper; (Research paper)
LANGUAGE: ENGLISH
CHARACTER COUNT: 1680
ORGN Class: DICOT Family: MYRTACEAE Genus: SYZYGIIUM Species: AROMATICUM
Synonym(s): EUGENIA CARYOPHYLLATA
Organism part: DRIED FLOWER BUDS
TYPE OF STUDY (STY): IN VITRO. Classification (CC): MUTAGENIC ACTIVITY
Extract type: ESSENTIAL OIL
Dosage Information: AGAR PLATE; CONC USED: 1 MG per ML
Pathological system: SALMONELLA TYPHIMURIUM
Qualitative results: ACTIVE
Comment(s): SEE ARTICLE FOR OTHER TEST RESULTS. VS.AMES MUTAGENICITY
ASSAY.
ORGN Class: DICOT Family: LAURACEAE Genus: CINNAMOMUM Species: ZEYLANICUM
Organism part: DRIED BARK
TYPE OF STUDY (STY): IN VITRO. Classification (CC): MUTAGENIC ACTIVITY
Extract type: ESSENTIAL OIL
Dosage Information: AGAR PLATE; CONC USED: 2 MG per ML
Pathological system: SALMONELLA TYPHIMURIUM
Qualitative results: INACTIVE
Comment(s): VS.AMES MUTAGENICITY ASSAY. SEE ARTICLE FOR OTHER TEST
RESULTS.
ORGN Class: DICOT Family: LAMIACEAE Genus: THYMUS Species: VULGARIS
Organism part: DRIED AERIAL PARTS
TYPE OF STUDY (STY): IN VITRO. Classification (CC): MUTAGENIC ACTIVITY
Extract type: ESSENTIAL OIL
Dosage Information: AGAR PLATE; CONC USED: 2 MG per ML
Pathological system: SALMONELLA TYPHIMURIUM
Qualitative results: INACTIVE
Comment(s): VS.AMES MUTAGENICITY ASSAY. SEE ARTICLE FOR OTHER TEST
RESULTS.
ORGN Class: DICOT Family: LAMIACEAE Genus: ZATARIA Species: MULTIFLORA
Organism part: PART NOT SPECIFIED
TYPE OF STUDY (STY): IN VITRO. Classification (CC): MUTAGENIC ACTIVITY
Extract type: ESSENTIAL OIL
Dosage Information: AGAR PLATE; CONC USED: 2 MG per ML
Pathological system: SALMONELLA TYPHIMURIUM

IMS New Product Focus

Description

IMS New Product Focus tracks worldwide pharmaceutical product launches, records the very first launch of a product in a particular country (New Active Substance) and identifies the indication and price (when available) at the time of the initial launch. Included are product name and composition, manufacturer's name and, where applicable, parent company, therapeutic class code, ingredients and package insert information.

IMS New Product Focus can be used to analyze the success of a new product launch and assess market penetration.

Subject Coverage

IMS New Product Focus covers 50 major world markets. Each record provides the following information for each product:

- composition (including form and dose)
- ingredients and local trade name
- therapeutic class code and indications (when available)
- manufacturing company
- first launch country and date, and subsequent launches
- presentation (pack information)
- launch price data (where available)

Price information includes hospital and retail price, if available. Biotechnology products are also identified, as well as first world launches of new chemical entities.

Date Coverage

1982 to the present

Update Frequency

Monthly

Geographic Coverage

International

Document Types

Newsletters

Publisher

IMS New Product Focus is produced by IMS Health. All questions concerning the database should be directed to:



IMS Health
Customer Services Dept., Global Services
210 Pentonville Road
London, N1 9JY
England

Telephone: +44 0207-393-5888
Fax: +44 0207-393-5346
E-Mail: service@imshealth.com
Web site: www.imshealth.com

In addition to *Search Options*, other tools available for searching are *Limit Options*, *Browse Fields*, *"Narrow Results By" Limiters*, and *Lookup Citation*. Each is listed separately below. Some data can be searched using more than one tool.

Full text < Back to results

< Previous

 Add to selected items Save to My Research  EmailTI
PUB,PD**DUOALMETEC****IMS New Product Focus** (Apr 28, 2014).

TX,FT

 Full Text [Translate](#)**New Product Focus - Launch Details**

CO

Company Information


Company Name:	MERCK SHARP DOHME
Parent Company:	MERCK & CO

Product Information

Trade Name:	DUOALMETEC
Composition:	amlodipine; olmesartan medoxomil
Launch Country:	Mexico
Product Launch Date:	01 May 2013
Therapeutic Classification:	C9D (Angiotensin-II Antagonists)
Indications on Pack:	Hypertension
Drug Status:	Branded; Existing Chemical Entity; Non-Biotechnology Product; Includes Package Pricing

New Product Focus - Pack Details**Pack Information**

Number of Ingredients:	2
Number of Packs:	6
Dose Form:	tabs
Composition (Active Ingredients):	tabs a: amlodipine besilate, 5 mg; olmesartan medoxomil base, 20 mg; tabs b: amlodipine besilate, 5 mg; olmesartan medoxomil base, 20 mg; tabs c: amlodipine besilate, 10 mg; olmesartan medoxomil base, 40 mg; tabs d: amlodipine besilate, 10 mg; olmesartan medoxomil base, 40 mg;

☐ Indexing (details)  Cite

NCE	New chemical entity	No
	Numeric indexing	Number of ingredients: 2; Number of packs: 6
TN	Trade name	DUOALMETEC
	Company	DUOALMETEC
TC	Therapeutic class	C9D: Angiotensin-II Antagonists
IND	Indication	Hypertension
GN	Generic name	amlodipine, olmesartan medoxomil
ST	Drug status	Branded
ELDT	Product launch date	2013-05-01
CO	Originator	MERCK SHARP DOHME Parent: MERCK & CO
TI	Title	DUOALMETEC
CLD	Phase	in Mexico.
LA	Language	English
DTYPE	Document type	Product Launch
PUB	Publication title	IMS New Product Focus
PSTYPE	Publication type	Newsletter
NT	Notes	Package/Price: tabs a 14: MXN 408.200 (RPP)(Mexican Peso); Package/Price: tabs b 28: MXN 785.090 (RPP)(Mexican Peso); Package/Price: tabs c 14: MXN 408.200 (RPP)(Mexican Peso); Package/Price: tabs d 28: MXN 785.090 (RPP)(Mexican Peso); Package/Price: tabs e 14: MXN 408.200 (RPP)(Mexican Peso); Package/Price: tabs f 28: MXN 785.090 (RPP)(Mexican Peso)
AV	Availability	Includes package pricing
PD	Publication date	Apr 28, 2014
DSTAT	Document status	New
	Source attribution	IMS New Product Focus, © Publisher specific
AN	Accession number	1494126
	Document URL	http://search.proquest.com/professional/docview/1514784222?accountid=137296
FAV	First available	2014-04-11
UD	Updates	2014-04-11
	Database	IMS New Product Focus (1982 - current)

IMSRESEARCH (IMS LifeCycle, R&D Focus)

Subject Coverage	<ul style="list-style-type: none"> All phases of drug development worldwide Biotechnological products New formulations 				
File Type	Substance				
Features	Thesaurus	None			
	Alerts (SDIs)	Weekly or Monthly			
	CAS Registry Number® Identifiers	<input checked="" type="checkbox"/>	Page Images	<input type="checkbox"/>	STN® AnaVist™ <input type="checkbox"/>
	Keep & Share	<input checked="" type="checkbox"/>	SLART	<input checked="" type="checkbox"/>	STN Easy® <input checked="" type="checkbox"/>
	Learning Database	<input type="checkbox"/>	Structures	<input type="checkbox"/>	STN® Viewer™ <input type="checkbox"/>
Record Content	<ul style="list-style-type: none"> Substance information CAS Registry Number and Chemical Name Structures Pharmacology 		<ul style="list-style-type: none"> Development and licensing status worldwide Scientific and commercial summaries Abstracts of significant scientific papers 		
File Size	More than 35,260 records (12/13)				
Coverage	1977-present				
Updates	Weekly				
Language	English				
Database Producer	IMS HEALTH 210 Pentonville Road London N1 9JY United Kingdom Phone: (+44) 020 3075 5888 Email: info@uk.imshealth.com Web: http://www.imshealth.com				

IMSRESEARCH

Sources

Information is gathered from direct reports from companies on their research and development, conferences, patent and journal literature, and attendance at symposia on medical, clinical, and research subjects.

User Aids

- Anatomical Therapeutic Classification Codes (available from the producer)
 - Online Helps (HELP DIRECTORY lists all help messages available)
 - STNGUIDE
-

Clusters

- BIOSCIENCE
 - CASRNS
 - IMSBASES
 - PHARMACOLOGY
- [STN Database Clusters](#) information (PDF).
-

Pricing

Enter HELP COST at an arrow prompt (=>).

Sample Records

DISPLAY IALL

ACCESSION NUMBER: 2010:357 IMSRESEARCH
 SOURCE: R&D Focus, (04 Mar 2010)
 DOCUMENT NUMBER: 2500677
 STATUS: NEW DRUG
 LABORATORY NAME: ABT 072
 STRUCTURE:

STRUCTURE DIAGRAM IS NOT AVAILABLE

CLASSIFICATION: J5B1 Viral Hepatitis Products
 INDICATION: hepatitis C
 ACTION: RNA polymerase inhibitor
 ADMINISTRATION: oral
 HIGHEST DEV. PHASE: Phase II (40)
 ENTRY DATE: Entered STN: 8 Mar 2010
 Last Updated on STN: 6 Apr 2010

LATEST INFORMATION: 04 March 2010 : Abbott and Enanta announced on 2 March 2010 the initiation of a phase II trial of ABT 450, ABT 333 and ABT 072 in treatment-naive patients with hepatitis C virus (HCV) genotype 1 infection. ABT 450, a protease inhibitor developed by Abbott and Enanta, and ABT 333 and ABT 072, two non-nucleoside polymerase inhibitors developed exclusively by Abbott, will be dosed individually in combination with standard of care (SOC). The study will evaluate the safety, tolerability, pharmacokinetics and antiviral activity of the agents. After a three-day monotherapy period, each antiviral agent will be administered with pegIFN and ribavirin (SOC) for 12 weeks, followed by SOC alone for an additional 36 weeks.

CURRENT DEVELOPMENT STATUS:

Type	Status	Stage	Region	Indication
Highest Phase	Phase II	40		
Phase	Phase II	40	United States	hepatitis C

COMPANY INFORMATION:

Type	Company	Nationality	Corporation
Originator	Abbott	USA	Abbott (United States)

COMMERCIAL SUMMARY:

Commercial overview. Overview

Abbott is developing ABT 072, a non-nucleoside polymerase inhibitor, for the treatment of hepatitis C virus (HCV) infection. A phase II trial of the agent initiated in February 2010 in patients with HCV genotype 1 infection.

R&D progress. **Hepatitis C**

Phase II, Abbott, USA.---DESIGN: Trial started - Feb 2010. A randomized, double-blind, parallel assignment phase II trial of ABT 450, ABT 333 and ABT 072 has been initiated in treatment-naive patients with hepatitis C virus (HCV) genotype 1 infection. The agents will be dosed individually in combination with standard of care (SOC). The study will evaluate the safety, tolerability, pharmacokinetics and antiviral activity of the agents. After a three-day monotherapy period, each antiviral agent will be administered with pegIFN and ribavirin (SOC) for 12 weeks, followed by SOC alone for an additional 36 weeks.

CBNB (Chemical Business NewsBase)

Subject Coverage	News affecting the chemical industry: <ul style="list-style-type: none"> • Company information • Products and production • Market information • Environmental aspects • Legal aspects and regulations 																														
File Type	Bibliographic																														
Features	<table border="0"> <tr> <td>Thesaurus</td> <td>None</td> <td></td> <td></td> <td></td> <td></td> </tr> <tr> <td>Alerts (SDIs)</td> <td>Weekly</td> <td></td> <td></td> <td></td> <td></td> </tr> <tr> <td>CAS Registry Number[®] Identifiers</td> <td><input checked="" type="checkbox"/></td> <td>Page Images</td> <td><input type="checkbox"/></td> <td>STN[®] AnaVist™</td> <td><input type="checkbox"/></td> </tr> <tr> <td>Keep & Share</td> <td><input checked="" type="checkbox"/></td> <td>SLART</td> <td><input checked="" type="checkbox"/></td> <td>STN Easy[®]</td> <td><input checked="" type="checkbox"/></td> </tr> <tr> <td>Learning Database</td> <td><input type="checkbox"/></td> <td>Structures</td> <td><input type="checkbox"/></td> <td>STN[®] Viewer™</td> <td><input type="checkbox"/></td> </tr> </table>	Thesaurus	None					Alerts (SDIs)	Weekly					CAS Registry Number[®] Identifiers	<input checked="" type="checkbox"/>	Page Images	<input type="checkbox"/>	STN [®] AnaVist™	<input type="checkbox"/>	Keep & Share	<input checked="" type="checkbox"/>	SLART	<input checked="" type="checkbox"/>	STN Easy[®]	<input checked="" type="checkbox"/>	Learning Database	<input type="checkbox"/>	Structures	<input type="checkbox"/>	STN [®] Viewer™	<input type="checkbox"/>
Thesaurus	None																														
Alerts (SDIs)	Weekly																														
CAS Registry Number[®] Identifiers	<input checked="" type="checkbox"/>	Page Images	<input type="checkbox"/>	STN [®] AnaVist™	<input type="checkbox"/>																										
Keep & Share	<input checked="" type="checkbox"/>	SLART	<input checked="" type="checkbox"/>	STN Easy[®]	<input checked="" type="checkbox"/>																										
Learning Database	<input type="checkbox"/>	Structures	<input type="checkbox"/>	STN [®] Viewer™	<input type="checkbox"/>																										
Record Content	Records contain bibliographic information, controlled indexing for company and country names, chemical names and important concepts, CAS Registry Numbers, and an abstract.																														
File Size	More than 1.65 million records (7/2014)																														
Coverage	1984-present																														
Updates	Daily																														
Language	English																														
Database Producer	Elsevier Engineering Information Inc. 1 Castle Point Terrace Hoboken, New Jersey 07030-5996 USA Phone: +1 201 216-8500 Fax: +1 201 216-8532 Email: ei@ei.org Copyright Holder																														

**Database
Supplier**

FIZ Karlsruhe
 STN Europe
 P.O. Box 2465
 76012 Karlsruhe
 Germany
 Phone: +49-7247-808-555
 Fax: +49-7247-808-259
 Email: helpdesk@fiz-karlsruhe.de

Sources

- Newspapers
- Journals
- Company reports
- Stockbroker reports
- Market research reports
- Books
- Press releases
- Trade literature
- Advertisements
- Government and EU publications
- Directories

User Aids

- CBNB User Manual (incl. Chemicals Index) *
 - CBNB Core Sources List
http://www.stn-international.de/fileadmin/be_user/STN/pdf/database_details/CBNB_HCSL_issue_15.pdf
 - Online Helps (HELP DIRECTORY lists all help messages available)
 - STNGUIDE
- * available from producer

Clusters

- AGRICULTURE
- ALLBIB
- BUSINESS
- CASRNS
- CHEMENG
- CHEMISTRY
- COMPANIES
- ENVIRONMENT
- FUELS
- GOVREGS
- HEALTH
- MATERIALS
- PETROLEUM
- PHARMACOLOGY
- POLYMERS

[STN Database Clusters](#) information (PDF)

Pricing

Enter HELP COST at an arrow prompt.

DISPLAY ALL OF PRESS RELEASE

AN 26(47):64544 CBNB

TI Potash One agrees to friendly takeover by K+S for C\$4.50 per share in cash.

SO (22 Nov 2010), (200-899 words)

Availability: K+S AG, Bertha-von-Suttner-Strasse 7, 34131 Kassel, Germany, tel: +49 5619 3010, fax: +49 5619 30117 53, website:

www.k-plus-s.com

DT Press Release; (Column)

LA English

PY 2010

AB On 22 Nov 2010, K+S AG and Potash One Inc announced that they have entered into a Support Agreement pursuant to which K+S will make an offer to acquire all of the issued and outstanding common shares of Potash One at a price of C\$4.50 per share in cash for total consideration of approximately C\$434 M (EUR 311 M). The offer represents a: 24.3% premium to the closing price of Potash One shares on 19 Nov 2010 on the Toronto Stock Exchange; 31.3% premium over the 10-day weighted average trading price of the shares up to and including 19 Nov 2010; and 82.2% premium to Potash One's share price of CAD 2.47 on 16 Aug 2010, the day prior to Potash Corp's rejection of BHP Billiton's unsolicited proposal. The Potash One Board of Directors has unanimously determined that the transaction is fair to Potash One shareholders and is in the best interests of the company and its shareholders. The Board recommends that shareholders tender their common shares to the offer. Potash One's Board has received an opinion from GMP Securities L.P. that the consideration to be received by the Potash One shareholders under the offer is fair from a financial point of view to those shareholders. Potash One holds several potash exploration licenses in the Canadian province of Saskatchewan, including the Legacy Project, an advanced greenfield project to develop a potash solution mine. K+S estimates production capacity of up to 2.7 M tonnes/y of potassium chloride. The realisation of this production capacity would represent an approximately \$2.5 bn capital investment into Saskatchewan and create up to 300 highly-skilled jobs. The project headquarters will be located in Saskatchewan, Canada. K+S expects initial production no earlier than 2015.

CC MS-06

Fertilizers

CO Kali und Salz (K+S); Potash One

GT 1112: GERMANY; 2103: CANADA

CT mergers and acquisitions; investment; plant capacity; employment

CN potassium chloride

RN 7447-40-7

SIC 28194 Potassium and Sodium Compounds



Fontes de Informações Patentárias (Gratuitas)

- INPI (<https://gru.inpi.gov.br/pePI/servlet/LoginController?action=login>)
- USPTO (<http://patft.uspto.gov>)
- USPTO PAIR (<http://portal.uspto.gov/pair/PublicPair>)
- Espacenet (<http://worldwide.espacenet.com>)
- Epoline Register Plus (<https://register.epo.org/regviewer>)
- Google patents, WIPOI, Etc...
- Intellogist (www.intellogist.com)

**Marca****Patente****Desenho Industrial****Indicação Geográfica****Programa de
Computador****Topografia de
Circuitos Integrados****Transferência de
Tecnologia****Informação Tecnológica
de Patentes****NOTA:**

- Para efeitos legais a Revista Eletrônica da Propriedade Industrial (RPI) é o único canal destinado a publicar os atos, despachos e decisões relacionados às atividades da Autarquia.
- O acervo contido na base de dados está restrito a documentos publicados a partir do ano 2000, cujos dados foram publicados oficialmente na Revista da Propriedade Industrial.



BRASIL

Acesso à informação

Participe

Serviços

Legislação

Canais

Instituto Nacional da Propriedade Industrial

Ministério do Desenvolvimento, Indústria e Comércio Exterior






Consulta à Base de Dados do INPI

[[Início](#) | [Ajuda?](#)  | [Login](#) | [Cadastre-se aqui.](#)]

» Consultar por: **Base Patentes** | [Pesquisa Básica](#) | [Calendário](#) | [Finalizar Sessão](#)

PESQUISA AVANÇADA

Forneça abaixo as chaves de pesquisa desejadas. Evite o uso de frases ou palavras genéricas.

<input checked="" type="radio"/> Números	(21) Nº do Pedido: <input type="text"/> 	<input type="radio"/> Calendário de Patentes expiradas/a expirar 
		<input type="radio"/> Patente Concedida 
	(33)/(31) País/Nº da Prioridade: <input type="text"/> 	
	(86) Nº do Depósito (PCT): <input type="text"/> 	
<input checked="" type="radio"/> Datas		
<input checked="" type="radio"/> Classificação		
<input checked="" type="radio"/> Palavra Chave		
<input checked="" type="radio"/> Depositante/Titular/Inventor		

Nº de Processos por Página: ▼

Rua Mayrink Veiga, 9 - Centro - RJ - CEP: 20090-910 | Rua São Bento, 1 - Centro - RJ - CEP: 20090-010





Depósito de pedido nacional de Patente

(21) Nº do Pedido: **MU 8702761-5 U2**

(22) Data do Depósito: 26/10/2007

(43) Data da Publicação: 23/06/2009

(47) Data da Concessão: -

(51) Classificação - IntCL: **E05B 19/00 ; B60R 25/00**

(54) Título: CHAVE CANIVETE COM ESPAÇO RESERVADO PARA ALARME E DISPOSITIVO DE ARMAZENAMENTO DE DADOS
CHAVE CANIVETE COM ESPAÇO RESERVADO PARA ALARME E DISPOSITIVO DE ARMAZENAMENTO DE DADOS. Pertencente ao ramo de componentes automotivos, compreendido pelo acréscimo a uma chave tipo canivete (1) uma chave deslizante (5) que permite que um mmi pen drive (6) saia da caixa plástica (3) que reveste a chave e os outros componentes, através de um orifício (7) que permite por fim que o usuário acople a entrada especificada pelo mesmo.

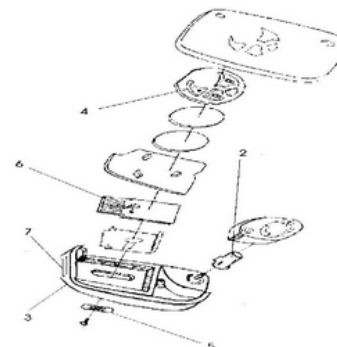
(71) Nome do Depositante: Marcio Zuicker de Camargo Castanho (BR/SP)

(72) Nome do Inventor: Marcio Zuicker de Camargo Castanho

(74) Nome do Procurador: Autoral Patentes e Marcas S/C LTDA.



Documento Publicado



Petições ?

Pgo	Protocolo	Data	Img	Serviço	Cliente	Delivery	Data
✓	018080009409	20/02/2008	-	206	Marcio Zuicker de Camargo Castanho		-
✓	018070071114	26/10/2007	-	200	Marcio Zuicker de Camargo Castanho		-

Publicações ?

RPI	Data RPI	Despacho	Complemento do Despacho
2113	05/07/2011	11.1.1	
2098	22/03/2011	11.1	
2007	23/06/2009	3.1	
1951	27/05/2008	2.1	

USPTO PATENT FULL-TEXT AND IMAGE DATABASE

[Home](#)[Quick](#)[Advanced](#)[Pat Num](#)[Help](#)[View Cart](#)

Data current through August 25, 2015..

Query [\[Help\]](#)

Examples:

ttl/(tennis and (racquet or racket))

isd/1/8/2002 and motorcycle

in/newmar-julie

Select Years [\[Help\]](#)

Patents from 1790 through 1975 are searchable only by Issue Date, Patent Number, and Current Classification (US, IPC, or CPC).

When searching for specific numbers in the Patent Number field, patent numbers must be seven characters in length, excluding commas, which are optional.

Field Code	Field Name	Field Code	Field Name
PN	Patent Number	IN	Inventor Name
ISD	Issue Date	IC	Inventor City
TTL	Title	IS	Inventor State
ABST	Abstract	ICN	Inventor Country
ACLM	Claim(s)	AANM	Applicant Name
SPEC	Description/Specification	AACI	Applicant City
CCL	Current US Classification	AAST	Applicant State
CPC	Current CPC Classification	AACO	Applicant Country
CPCL	Current CPC Classification Class	AAAT	Applicant Type
ICL	International Classification	LREP	Attorney or Agent
APN	Application Serial Number	AN	Assignee Name
APD	Application Date	AC	Assignee City
APT	Application Type	AS	Assignee State
GOVT	Government Interest	ACN	Assignee Country
FMID	Patent Family ID	EXP	Primary Examiner
PARN	Parent Case Information	EXA	Assistant Examiner
PLAP	Related US App. Data	REF	Referenced By

USPTO PATENT FULL-TEXT AND IMAGE DATABASE

[Home](#)[Quick](#)[Advanced](#)[Pat Num](#)[Help](#)[Next List](#)[Bottom](#)[View Cart](#)

Searching US Patent Collection...

















Results of Search in US Patent Collection db for:

TTL/(pocket AND tool): 90 patents.

Hits 1 through 50 out of 90

**PAT.
NO.**

Title

- 1 [9,073,192](#)  [Pocket driver tool](#)
- 2 [D732,368](#)  [Multi-purpose pocket tool](#)
- 3 [D731,270](#)  [Pocket field tool bit](#)
- 4 [D705,536](#)  [Two pocket retractable tool pouch for attaching to a tool belt or a body harness vertical strap](#)
- 5 [8,647,026](#)  [Cutting tool with pocket feature for reducing stress](#)
- 6 [D696,918](#)  [Pocket driver tool](#)
- 7 [8,596,933](#)  [Cutting tool having pocket bottom with base and inclined surfaces](#)
- 8 [8,528,215](#)  [Pocket tool, in particular a pocket knife](#)
- 9 [8,403,141](#)  [Tool bag with secure-pocket configuration](#)
- 10 [8,368,318](#)  [Pocket tool with a light pointer](#)
- 11 [8,225,696](#)  [Method of manufacturing a pocket tool](#)
- 12 [D658,964](#)  [Pocket tool with control panel](#)
- 13 [8,091,627](#)  [Stress relief in a pocket of a downhole tool string component](#)
- 14 [8,087,181](#)  [Valve body seat pocket inspection tool](#)
- 15 [8,029,214](#)  [Pocket hole jig tool system](#)
- 16 [D645,722](#)  [Multi-function pocket tool](#)

Patent eBusiness

- [Electronic Filing](#)
- [Patent Application Information \(PAIR\)](#)
- [Patent Ownership](#)
- [Fees](#)
- [Supplemental Resources & Support](#)

Patent Information

- [Patent Guidance and General Info](#)
- [Codes, Rules & Manuals](#)
- [Employee & Office Directories](#)
- [Resources & Public Notices](#)

Patent Searches

- [Patent Official Gazette](#)
- [Search Patents & Applications](#)
- [Search Biological Sequences](#)
- [Copies, Products & Services](#)

Other

- [Copyrights](#)
- [Trademarks](#)
- [Policy & Law](#)
- [Reports](#)

Patent Application Information Retrieval

Select New Case

Select New Case

* indicates a required field

You may search for a specific application or conduct a search related to a customer number.

Search for Application:

Choose type of number:

- Application Number (EXAMPLE: 99999999 or 99/999999)
- Control Number
- Patent Number
- PCT Number (EXAMPLE: PCT/CCYY/99999 or PCT/CCYYYY/999999)
- Publication Number
- International Design Registration Number (EXAMPLE: DM/999999)

* Enter number:

If you need help:

- Contact the Patent Electronic Business Center at (866) 217-9197 (toll free) or e-mail EBC@uspto.gov for specific questions about Patent Application Information Retrieval (PAIR).
- If you experience technical difficulties or problems with PAIR outside normal Patent Electronic Business Center hours (M-F, 6AM to 12AM ET), please call 1 800-786-9199.
- Send general questions about USPTO programs to the [USPTO Contact Center \(UCC\)](#).



- [Accessibility](#)
- [Privacy Policy](#)
- [Terms of Use](#)
- [Security](#)
- [Emergencies/Security Alerts](#)
- [Information Quality Guidelines](#)

- [Federal Activities Inventory Reform \(FAIR\) Act](#)
- [Notification and Federal Employee Antidiscrimination and Retaliation \(NoFEAR\) Act](#)
- [Budget & Performance](#)
- [Freedom of Information Act \(FOIA\)](#)

- [Department of Commerce NoFEAR Act Report](#)
- [Regulations.gov](#)
- [STOP!Fakes.gov](#)
- [Department of Commerce](#)
- [USA.gov](#)

- [Strategy Targeting Organized Piracy \(STOP!\)](#)
- [Careers](#)
- [Site Index](#)
- [Contact Us](#)
- [USPTO Webmaster](#)

Patent eBusiness

- [Electronic Filing](#)
- [Patent Application Information \(PAIR\)](#)
- [Patent Ownership](#)
- [Fees](#)
- [Supplemental Resources & Support](#)

Patent Information

- [Patent Guidance and General Info](#)
- [Codes, Rules & Manuals](#)
- [Employee & Office Directories](#)
- [Resources & Public Notices](#)

Patent Searches

- [Patent Official Gazette](#)
- [Search Patents & Applications](#)
- [Search Biological Sequences](#)
- [Copies, Products & Services](#)

Other

- [Copyrights](#)
- [Trademarks](#)
- [Policy & Law Reports](#)

Patent Application Information Retrieval

[Order Certified Application As Filed](#) [Order Certified File Wrapper](#) [View Order List](#)

10/965,638 **POCKET TOOL** **0425202**

Select New Case	Application Data	Transaction History	Image File Wrapper	Patent Term Adjustments	Continuity Data	Foreign Priority	Fees	Published Documents	Address & Attorney/Agent	Assignments	Display References
-----------------	------------------	---------------------	--------------------	-------------------------	-----------------	------------------	------	---------------------	--------------------------	-------------	--------------------

Bibliographic Data

Application Number:	10/965,638	Correspondence Address Customer Number:	-
Filing or 371 (c) Date:	10-14-2004	Status:	Patented Case
Application Type:	Utility	Status Date:	11-22-2006
Examiner Name:	THOMAS, DAVID B	Location:	ELECTRONIC
Group Art Unit:	3723	Location Date:	-
Confirmation Number:	8173	Earliest Publication No:	US 2005-0081302 A1
Attorney Docket Number:	0425202	Earliest Publication Date:	04-21-2005
Class / Subclass:	007/118	Patent Number:	7,146,667
First Named Inventor:	Carl Elsener , Ibach, (CH) all Inventors	Issue Date of Patent:	12-12-2006
First Named Applicant:	-	International Registration Number (Hague):	-
Entity Status:	Undiscounted	International Registration Publication Date:	-
AIA (First Inventor to File):	No		

Title of Invention: POCKET TOOL

If you need help:

- Contact the Patent Electronic Business Center at (866) 217-9197 (toll free) or e-mail EBC@uspto.gov for specific questions about Patent Application Information Retrieval (PAIR).
- If you experience technical difficulties or problems with PAIR outside normal Patent Electronic Business Center hours (M-F, 6AM to 12AM ET), please call 1 800-786-9199.
- Send general questions about USPTO programs to the [USPTO Contact Center \(UCC\)](#).



- » [Accessibility](#)
- » [Privacy Policy](#)
- » [Terms of Use](#)
- » [Security](#)
- » [Emergencies/Security Alerts](#)
- » [Information Quality Guidelines](#)

- » [Federal Activities Inventory Reform \(FAIR\) Act](#)
- » [Notification and Federal Employee Antidiscrimination and Retaliation \(NoFEAR\) Act](#)
- » [Budget & Performance](#)
- » [Freedom of Information Act \(FOIA\)](#)

- » [Department of Commerce NoFEAR Act Report](#)
- » [Regulations.gov](#)
- » [STOP!Fakes.gov](#)
- » [Department of Commerce](#)
- » [USA.gov](#)

- » [Strategy Targeting Organized Piracy \(STOP!\)](#)
- » [Careers](#)
- » [Site Index](#)
- » [Contact Us](#)
- » [USPTO Webmaster](#)

Patent eBusiness

- Electronic Filing
- Patent Application Information (PAIR)
- Patent Ownership
- Fees
- Supplemental Resources & Support

Patent Information

- Patent Guidance and General Info
 - Codes, Rules & Manuals
 - Employee & Office Directories
 - Resources & Public Notices

Patent Searches

- Patent Official Gazette
 - Search Patents & Applications
 - Search Biological Sequences
 - Copies, Products & Services

Other

- Copyrights
- Trademarks
- Policy & Law Reports

Patent Application Information Retrieval

Order Certified Application As Filed Order Certified File Wrapper View Order List

10/965,638 **POCKET TOOL** **0425202**

Select New Case Application Data Transaction History Image File Wrapper Patent Term Adjustments Continuity Data Foreign Priority Fees Published Documents Address & Attorney/Agent Assignments Display References

This application is officially maintained in electronic form. To View: Click the desired Document Description. To Download and Print: Check the desired document(s) and click Start Download.

Available Documents

Mail Room Date	Document Code	Document Description	Document Category	Page Count	PDF
12-22-2006	IRFND	Processed Request for Refund	PROSECUTION	2	<input type="checkbox"/>
11-22-2006	ISSUE.NTF	Issue Notification	PROSECUTION	1	<input type="checkbox"/>
11-02-2006	IFEE	Issue Fee Payment (PTO-85B)	PROSECUTION	2	<input type="checkbox"/>
08-10-2006	NOA	Notice of Allowance and Fees Due (PTOL-85)	PROSECUTION	3	<input type="checkbox"/>
08-10-2006	NOA	Notice of Allowance and Fees Due (PTOL-85)	PROSECUTION	3	<input type="checkbox"/>
08-10-2006	1449	List of References cited by applicant and considered by examiner	PROSECUTION	1	<input type="checkbox"/>
08-10-2006	IIFW	Issue Information including classification, examiner, name, claim, renumbering, etc.	PROSECUTION	1	<input type="checkbox"/>
08-10-2006	BIB	Bibliographic Data Sheet	PROSECUTION	1	<input type="checkbox"/>
08-10-2006	FWCLM	Index of Claims	PROSECUTION	1	<input type="checkbox"/>
08-10-2006	SRFW	Search information including classification, databases and other search related notes	PROSECUTION	1	<input type="checkbox"/>
07-25-2006	SRNT	Examiner's search strategy and results	PROSECUTION	2	<input type="checkbox"/>
06-19-2006	A...	Amendment/Req. Reconsideration-After Non-Final Reject	PROSECUTION	1	<input type="checkbox"/>
06-19-2006	CLM	Claims	PROSECUTION	20	<input type="checkbox"/>
06-19-2006	REM	Applicant Arguments/Remarks Made in an Amendment	PROSECUTION	3	<input type="checkbox"/>
06-19-2006	WFEE	Fee Worksheet (SB06)	PROSECUTION	1	<input type="checkbox"/>
05-17-2006	NTC.A.NONCPL	Notice to the applicant regarding a non-compliant or non-responsive amendment	PROSECUTION	2	<input type="checkbox"/>
05-09-2006	A.I.	Informal or Non-Responsive Amendment	PROSECUTION	2	<input type="checkbox"/>
05-09-2006	CLM.NE	Claim-Amendment Not Entered	PROSECUTION	19	<input type="checkbox"/>
05-09-2006	SPEC	Specification	PROSECUTION	12	<input type="checkbox"/>
05-09-2006	REM	Applicant Arguments/Remarks Made in an Amendment	PROSECUTION	13	<input type="checkbox"/>
05-09-2006	LET.	Miscellaneous Incoming Letter	PROSECUTION	1	<input type="checkbox"/>
05-09-2006	XT/	Extension of Time	PROSECUTION	3	<input type="checkbox"/>
05-09-2006	IDS	Information Disclosure Statement (IDS) Form (SB08)	PROSECUTION	2	<input type="checkbox"/>
05-09-2006	FOR	Foreign Reference	PRIOR ART	17	<input type="checkbox"/>
05-09-2006	WFEE	Fee Worksheet (SB06)	PROSECUTION	2	<input type="checkbox"/>
04-14-2006	XT/	Extension of Time	PROSECUTION	2	<input type="checkbox"/>
01-09-2006	XT/	Extension of Time	PROSECUTION	2	<input type="checkbox"/>
11-10-2005	CTNF	Non-Final Rejection	PROSECUTION	6	<input type="checkbox"/>
11-10-2005	892	List of references cited by examiner	PRIOR ART	1	<input type="checkbox"/>

Patent eBusiness

- [Electronic Filing](#)
- [Patent Application Information \(PAIR\)](#)
- [Patent Ownership](#)
- [Fees](#)
- [Supplemental Resources & Support](#)

Patent Information

- [Patent Guidance and General Info](#)
- [Codes, Rules & Manuals](#)
- [Employee & Office Directories](#)
- [Resources & Public Notices](#)

Patent Searches

- [Patent Official Gazette](#)
- [Search Patents & Applications](#)
- [Search Biological Sequences](#)
- [Copies, Products & Services](#)

Other

- [Copyrights](#)
- [Trademarks](#)
- [Policy & Law Reports](#)

Patent Application Information Retr

10/965,638 POCKET

Select New Case Application Data Transactio History

This application is officially maintai and click Start Download.

Available Documents

Mail Room Date	Docur
12-22-2006	IRFND
11-22-2006	ISSUE.NTR
11-02-2006	IFEE
08-10-2006	NOA
08-10-2006	NOA
08-10-2006	1449
08-10-2006	IIFW
08-10-2006	BIB
08-10-2006	FWCLM
08-10-2006	SRFW
07-25-2006	SRNT
06-19-2006	A...
06-19-2006	CLM
06-19-2006	REM
06-19-2006	WFEE
05-17-2006	NTC.A.NOM
05-09-2006	A.I.
05-09-2006	CLM.NE
05-09-2006	SPEC
05-09-2006	REM
05-09-2006	LET.
05-09-2006	XT/
05-09-2006	IDS
05-09-2006	FOR
05-09-2006	WFEE
04-14-2006	XT/
01-09-2006	XT/
11-10-2005	CTNF
11-10-2005	802

1. The disclosure is objected to because of the following informalities: The specification is objected to because, under the heading of Summary of the Invention, the applicant is describing the device based upon reference to the claimed subject matter, e.g. on page 4, the specification states, "The problem of the invention is resolved by the features defined in the characterizing clause of claim 1". This is not only objectionable, but considering that the content, scope and/or numbering of the claims may change during the prosecution, a description of the device based upon the claims, at the close of prosecution, may be different from that originally filed.

Appropriate correction is required.

Claim Rejections - 35 USC § 102

2. The following is a quotation of the appropriate paragraphs of 35 U.S.C. 102 that form the basis for the rejections under this section made in this Office action:

A person shall be entitled to a patent unless –

(e) the invention was described in (1) an application for patent, published under section 122(b), by another filed in the United States before the invention by the applicant for patent or (2) a patent granted on an application for patent by another filed in the United States before the invention by the applicant for patent, except that an international application filed under the treaty defined in section 351(a) shall have the effects for purposes of this subsection of an application filed in the United States only if the international application designated the United States and was published under Article 21(2) of such treaty in the English language.

3. Claims 1, 3, 5, 11-16, 18, 38, 40, and 41 are rejected under 35 U.S.C. 102(e) as being clearly anticipated by Yu (US 2004/0080989 A1).

4. Claim 116 is rejected under 35 U.S.C. 102(e) as being anticipated by Rivera (6,675,419).

Smart search

Quick search

Advanced search

Number search

Classification search

Quick help —

- [How many search terms can I enter per field?](#)
- [How do I enter words from the title or abstract?](#)
- [How do I enter words from the description or claims?](#)
- [Can I use truncation/wildcards?](#)
- [How do I enter publication, application, priority and NPL reference numbers?](#)
- [What is the difference between the IPC and the ECLA?](#)
- [What formats can I use for the publication date?](#)
- [How do I enter a date range for a publication date search?](#)

Related links +

Advanced search

Select the collection you want to search in [i](#)

Worldwide - collection of published applications from 90+ countries ▾

Enter your search terms - CTRL-ENTER expands the field you are in

Enter keywords in English

Title: [i](#) plastic and bicycle

Title or abstract: [i](#) hair

Enter numbers with or without country code

Publication number: [i](#) WO2008014520

EP0957704

Application number: [i](#) DE19971031696

Priority number: [i](#) WO1995US15925

Enter one or more dates or date ranges

Publication date: [i](#) yyyyymmdd

Enter name of one or more persons/organisations

Applicant(s): [i](#) Institut Pasteur

Inventor(s): [i](#) Smith

Enter one or more classification symbols

Euro Classification (ECLA): [i](#) F03G7/10

International Patent Classification (IPC): [i](#) H03M1/12

Clear

Search

Links diversos para citações, processos integrais, publicações PDF, legal status, famílias de patentes, etc.

About Espacenet Other EPO online services ▾

Search Result list My patents list (0) Query Settings

Refine search → Results → EP0957704 (A2)

EP0957704 (A2)

Bibliographic data

Description

Claims

Mosaics

Original document

Cited documents

Citing documents

INPADOC legal status

INPADOC patent family

Quick help

- [What does A1, A2, A3 and B stand for after a European publication number?](#)
- [What happens if I click on "In my patents list"?](#)
- [What happens if I click on the "EP Register" button?](#)
- [Why are some sidebar options deactivated for certain documents?](#)
- [How can I bookmark this page?](#)
- [Why does a list of documents with the heading "Also published as" sometimes appear, and what are these documents?](#)
- [Why do I sometimes find the abstract of a corresponding document?](#)
- [What happens if I click on the red "patent translate" button?](#)

Bibliographic data: EP0957704 (A2) — 1999-11-24

★ In my patents list ↗ EP Register → Report data error

 Print

PLATE-SHAPED HOLDER HOUSING FOR DAILY USE AND/OR CONSUMER ARTICLES

Page bookmark [EP0957704 \(A2\) - PLATE-SHAPED HOLDER HOUSING FOR DAILY USE AND/OR CONSUMER ARTICLES](#)

Inventor(s): PAINSITH HERMANN [AT] ±

Applicant(s): VICTORINOX AG [CH]; PAINSITH HERMANN [AT] ±

Classification: - international: [A45C11/00](#); [A45D29/20](#); [B29C65/02](#); [C12N15/53](#); [A45C11/18](#); [A45C11/32](#); (IPC1-7): [A45C11/00](#); [A45D29/20](#)

- Euro: [A45C11/00](#); [A45D29/20](#)

Application number: EP19960939748 19961202

Priority number(s): WO1996AT00238 19961202; AT19950001961 19951130

Also published as: [EP0957704 \(B1\)](#) [EP0957704 \(B2\)](#) [WO9719856 \(A2\)](#) [WO9719856 \(A3\)](#) [US2001047946 \(A1\)](#)
→ [more](#)

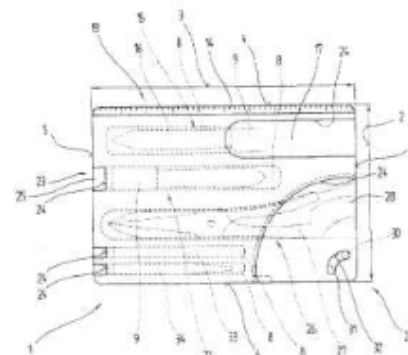
Abstract not available for EP0957704 (A2)

Abstract of corresponding document: WO9719856 (A2)

Translate this text into

 powered by EPO and Google

The invention concerns a plate-shaped metal or plastics housing (1) with at least one internal chamber (8) for holding at least one object. The chamber (8) is delimited by a base plate (6) and at least at given points by a cover plate (7) of the housing (1), the cover plate (7) being parallel to the base plate (6). The housing (1) comprises a plurality of chambers (8) which are disposed adjacent one another in a plane extending parallel to the base plate (6) and/or cover plate (7) and are at least partially separate from one another. The chambers (8) are designed to hold objects such as daily use (9) and/or consumer articles and are accessible from the exterior via openings (23) which are disposed in at least one of the transverse side surfaces (5) and/or longitudinal side surfaces (4) which preferably extend at right-angles to the base plate (6) and/or cover plate (7).



Acesso a publicações integrais de diversos países, incluindo publicações de pedidos BR

EP0957704 (B2)

Bibliographic data

Description

Claims

Mosaics

Original document

Cited documents

Citing documents

INPADOC legal status

INPADOC patent family

Quick help

- [What happens if I click on "In my patents list"?](#)
- [What happens if I click on the "EP Register" button?](#)
- [How can I maximise the page view?](#)
- [How can I download documents?](#)

Original document EP0957704 (B2) — 2006-07-05

In my patents list EP Register Report data error

Print

PLATE-SHAPED HOLDER HOUSING FOR DAILY USE AND/OR CONSUMER ARTICLES

Page 1/54 Bibliography Maximise Download

(19)  **Europäisches Patentamt**
European Patent Office
Office européen des brevets

(11)  **EP 0 957 704 B2**

(12) **NEUE EUROPÄISCHE PATENTSCHRIFT**

(45) Veröffentlichungstag und Bekanntmachung des
Hinweises auf die Entscheidung über den Einspruch:
05.07.2006 Patentblatt 2006/27

(51) Int. Cl.:
A45C 11/00 (2006.01) A45D 29/20 (2006.01)

(45) Hinweis auf die Patenterteilung:
08.10.2003 Patentblatt 2003/41

(86) Internationale Anmeldenummer:
PCT/AT1996/000238

(21) Anmeldenummer: **96939748.8**

(87) Internationale Veröffentlichungsnummer:
WO 1997/019856 (05.06.1997 Gazette 1997/24)

(22) Anmeldetag: **02.12.1996**

(54) **PLATTENFÖRMIGES AUFNAHMEGEHÄUSE FÜR GEBRAUCHS- UND/ODER VERBRAUCHSGEGENSTÄNDE**
PLATE-SHAPED HOLDER HOUSING FOR DAILY USE AND/OR CONSUMER ARTICLES
ETUI PLAT POUR OBJETS D'UTILISATION COURANTE OU DE CONSOMMATION

(84) Benannte Vertragsstaaten:
AT CH DE ES FR GB IT LI PT

(72) Erfinder: **PAINSITH, Hermann**
A-9020 Klagenfurt (AT)

(30) Priorität: **30.11.1995 AT 196195**

(74) Vertreter: **Secklehner, Günter**
Rechtsanwalt,
Pyhrnstrasse 1
8940 Liezen (AT)

(43) Veröffentlichungstag der Anmeldung:
24.11.1999 Patentblatt 1999/47

(60) Teilanmeldung:
02028246.3 / 1 293 144

(56) Entgegenhaltungen:
WO-A-93/22948 WO-A-94/29083
DE-A- 3 843 303 DE-C- 2 416 752
DE-C- 3 827 536 DE-U- 9 316 522
FR-A- 739 682 FR-A- 2 656 779
GB-A- 2 446 622

(73) Patentinhaber:
• **VICTORINOX AG**
CH-3600 Thun (CH)

Informações resumidas sobre andamento processual em diversos países

[About Espacenet](#) [Other EPO online services](#) ▾

[Search](#) [Result list](#) [★ My patents list \(0\)](#) [Query history](#) [Settings](#)

[Refine search](#) → [Results](#) → EP0957704 (A2)

- EP0957704 (A2)
- Bibliographic data
- Description
- Claims
- Mosaics
- Original document
- Cited documents
- Citing documents
- INPADOC legal status**
- INPADOC patent family

Quick help ▾

- [What happens if I click on "In my patents list"?](#)
- [What happens if I click on the "EP Register" button?](#)
- [What does "legal status" mean?](#)
- [Why is the legal status not always available?](#)
- [How might this information be useful to me?](#)
- [How reliable is this data?](#)
- [What are legal status \(PRS\) codes?](#)

INPADOC legal status: 0957704 (A2) — 1999-11-24

★ [In my patents list](#) [EP Register](#) → [Report data error](#) [Print](#)

PLATE-SHAPED HOLDER HOUSING FOR DAILY USE AND/OR CONSUMER ARTICLES

The EPO does not accept any responsibility for the accuracy of data and information originating from other authorities than the EPO; in particular, the EPO does not guarantee that they are complete, up-to-date or fit for specific purposes.

Legal status of EP0957704 (A2) 1999-11-24; EP0957704 (B1) 2003-10-08; EP0957704 (B2) 2006-07-05:

EP	F	96939748 A	(Patent of invention)
	PRS Date :	1999/11/24	
	PRS Code :	AK	
	Code Expl.:	+ DESIGNATED CONTRACTING STATES:	
	KD OF CORRESP. PAT. :	A2	
	DESIGNATED COUNTR. :	AT CH DE ES FR GB IT LI PT	
	PRS Date :	1999/11/24	
	PRS Code :	17P	
	Code Expl.:	+ REQUEST FOR EXAMINATION FILED	
	EFFECTIVE DATE :	19980828	
	PRS Date :	2001/10/04	
	PRS Code :	17Q	
	Code Expl.:	+ FIRST EXAMINATION REPORT	
	EFFECTIVE DATE :	20010816	
	PRS Date :	2003/10/08	
	PRS Code :	AK	
	Code Expl.:	+ DESIGNATED CONTRACTING STATES:	
	KD OF CORRESP. PAT. :	B1	
	DESIGNATED COUNTR. :	AT CH DE ES FR GB IT LI PT	
	PRS Date :	2003/10/08	

KD OF CORRESP. PAT. : T3

PRS Date : 2004/07/23

PRS Code : ET

Code Expl.: + FR: TRANSLATION FILED

PRS Date : 2004/09/01

PRS Code : 26

Code Expl.: - OPPOSITION FILED

OPPONENT NAME : VEREINIGTE STAHLWARENFABRIKEN GEBR. RICHARTZ + SOE

EFFECTIVE DATE : 20040708

PRS Date : 2006/07/05

PRS Code : 27A

Code Expl.: MAINTAINED AS AMENDED

EFFECTIVE DATE : 20060705

PRS Date : 2006/07/05

PRS Code : AK

Code Expl.: + DESIGNATED CONTRACTING STATES:

KD OF CORRESP. PAT. : B2

DESIGNATED COUNTR. : AT CH DE ES FR GB IT LI PT

PRS Date : 2006/07/31

PRS Code : REG CH AEN

Code Expl.: MODIFICATION OF THE SCOPE OF THE PATENT

FURTHER INFORMATION : AUFRECHTERHALTUNG DES PATENTES IN GEÄNDERTER FORM

PRS Date : 2006/11/01

PRS Code : GBTA

Code Expl.: + GB: TRANSLATION OF AMENDED EP PATENT FILED (GB SECTION 77(6)(B)/1977)

PRS Date : 2007/02/16

PRS Code : ET3

Code Expl.: + FR: TRANSLATION FILED ** DECISION CONCERNING OPPOSITION

PRS Date : 2007/03/16

PRS Code : REG ES DC2A

Code Expl.: PATENT MODIFIED

KD OF CORRESP. PAT. : T5

Histórico e acesso integral a todas as comunicações entre o EPO e os titulares e, eventualmente, Oponentes

[← About European Patent Register](#) [Other EPO online services](#) ▾

[Login](#)

[Smart search](#) [Quick search](#) [Advanced search](#) [Help](#)

EP0957704

About this file

[Legal status](#)

[Event history](#)

[Citations](#)

[Patent family](#)

[All documents](#)

About this file: EP0957704

[Refine search](#) [ST36](#) [Show history](#) [Espacenet](#) [Submit observations](#) [Report error](#) [Print](#)

EP0957704 - PLAIN SHAPED HOLDER HOUSING FOR DAILY USE AND/OR CONSUMER ARTICLES [\[Right-click to bookmark this link \]](#)

Status Patent maintained as amended
 Database last updated on 23.11.2012
Most recent event i 04.01.2008 Lapse of the patent in a contracting state published on 06.02.2008 [2008/06]

Quick help ▾

- [What happens if I click on the "XML" or "ST36" buttons?](#)
- [What kind of information can be found if I click on the "Show history" button?](#)
- [What kind of information can be found under "Status"?](#)
- [What do the digits in square brackets refer to?](#)
- [What does N/P stand for?](#)
- [Why are the publication dates of the European and international applications identical?](#)
- [What does the letter in square brackets stand for in the "Documents cited" part?](#)
- [Is it possible to navigate in the result list?](#)

[Maintenance news](#) +

[News flashes](#) +

[Related links](#) +

Applicant(s) For all designated states
 VICTORINOX AG
 Schmiedgasse 57
 8438 Ibach / CH
 For all designated states
 Painsith, Hermann
 Wulfengasse 6
 9020 Klagenfurt / AT
 [1999/47]

Inventor(s) 01 / PAINSITH, Hermann
 Wulfengasse 6
 A-9020 Klagenfurt / AT
 [1999/47]

Representative(s) Secklehner, Günter
 Rechtsanwalt, Pyhrnstrasse 1
 8940 Liezen / AT
 [N/P]

Application number, filing date 96939748.8 02.12.1996
 [1999/47]

WO1996AT00238
Priority number, date AT19950001961 30.11.1995 Original published format: TA 196195
 [1999/47]

Filing language DE

Procedural language DE

Publication **Type :** A2 Application without search report

No. : WO9719856

Date : 05.06.1997

Histórico e acesso integral a todas as comunicações entre o EPO e os titulares e, eventualmente, Oponentes

- EP0957704
- About this file
- Legal status
- Event history
- Citations
- Patent family
- All documents**

Quick help --

- [Is it possible to download one or more of the documents?](#)
- [Is it possible to print a list of all the documents?](#)
- [Can I sort the list of documents?](#)
- [Is it possible to open a the document?](#)
- [Can I open multiple documents in separate windows?](#)
- [Is it possible to print documents?](#)

Maintenance news +

News flashes +

Related links +

All documents: EP0957704

Refine search
 Select documents
 Espacenet
 Submit observations
 Report error
 Print

<input type="checkbox"/>	Date	Document type	Procedure	Number of pages
<input type="checkbox"/>	17.07.2007	Termination of the opposition proceedings with maintenance of patent	Opposition	2
<input type="checkbox"/>	08.06.2006	Decision to maintain the European patent in amended form	Opposition	1
<input type="checkbox"/>	08.06.2006	Decision to maintain the European patent in amended form	Opposition	1
<input type="checkbox"/>	23.05.2006	English translation of the claims	Opposition	4
<input type="checkbox"/>	23.05.2006	French translation of claims	Opposition	5
<input type="checkbox"/>	23.05.2006	Letter regarding the opposition procedure (no time limit)	Opposition	2
<input type="checkbox"/>	11.04.2006	Communication of bibliographic data	Opposition	1
<input type="checkbox"/>	11.04.2006	Communication to opponent concerning maintenance	Opposition	2
<input type="checkbox"/>	11.04.2006	Communication with request to pay printing fees and file translations	Opposition	2
<input type="checkbox"/>	07.04.2006	Maintenance of the patent with the documents specified in the final decision	Opposition	1
<input type="checkbox"/>	07.01.2006	Acknowledgement of a document	Opposition	1
<input type="checkbox"/>	29.12.2005	Advice of delivery	Opposition	1
<input type="checkbox"/>	23.12.2005	Druckexemplar	Opposition	56
<input type="checkbox"/>	23.12.2005	Grounds for the decision (Annex) - opposition	Opposition	8
<input type="checkbox"/>	23.12.2005	Interlocutory decision in opposition proceedings	Opposition	2
<input type="checkbox"/>	23.12.2005	Internal form - Opposition/addressees	Opposition	1
<input type="checkbox"/>	10.12.2005	Description	Opposition	7
<input type="checkbox"/>	10.12.2005	Description	Opposition	7
<input type="checkbox"/>	10.12.2005	Reply to an examination report in opposition proceedings	Opposition	2
<input type="checkbox"/>	17.11.2005	Annex to the communication - opposition	Opposition	1

About Espacenet Other EPO online services ▾

Search Result list **★ My patents list (0)** Query history Settings

Refine search → Results → EP0957704 (A2) → Family page 1

EP0957704 (A2)

Bibliographic data
 Description
 Claims
 Mosaics
 Original document
 Cited documents
 Citing documents
 INPADOC legal status

INPADOC patent family

Quick help

- [Can I export this list?](#)
- [What happens if I click on "Download covers"?](#)
- [Can I sort the list?](#)
- [What happens if I click on the star icon?](#)
- [What is a patent family?](#)
- [What is an INPADOC patent family?](#)
- [Are all the documents in an INPADOC family equivalents?](#)
- [Why is the same document published several times in the same country?](#)

Pesquisa a documentos
 "correspondentes" e
 outros membros de
 família de patente
 "expandida" do
 INPADOC

Family list: EP0957704 (A2) 1999-11-24

Select all Compact Sort (CSV | XLS)

17 application(s) for EP0957704 (A2)

▸
 page 1

Sort by Sort order

<input type="checkbox"/>	1. PLATE-SHAPED HOLDER HOUSING FOR DAILY USE AND/OR CONSUMER ARTICLES					
★	Inventor:	Applicant:	EC:	IPC:	Publication info:	Priority date:
	PAINSITH HERMANN [AT]	VICTORINOX AG [CH] PAINSITH HERMANN [AT]	A45C11/00 A45D29/20	A45C11/00 A45D29/20 B29C85/02 (+5)	AT251398 (T) 2003-10-15	1995-11-30
<input type="checkbox"/>	2. PLATE-SHAPED HOLDER HOUSING FOR DAILY USE AND/OR CONSUMER ARTICLES					
	PAINSITH HERMANN [AT]	PAINSITH HERMANN [AT] VICTORINOX AG [CH]	A45C11/00 A45D29/20	A45C11/00 A45D29/20 B29C85/02 (+5)	AT277538 (T) 2004-10-15	1995-11-30
<input type="checkbox"/>	3. PLATE-SHAPED HOLDER HOUSING FOR DAILY USE AND/OR CONSUMER ARTICLES					
		PAINSITH HERMANN DIPL ING [AT]	A45C11/00 A45D29/20	A45C11/00 A45D29/20 B29C85/02 (+4)	ATA198195 (A) 1998-02-15 AT404237 (B) 1998-09-25	1995-11-30
<input type="checkbox"/>	4. Plate-shaped holder housing for daily use and/or consumer articles					
	PAINSITH HERMANN	HERMANN PAINSITH VICTORINOX AG	A45C11/00 A45D29/20	A45C11/00 A45D29/20 B29C85/02 (+4)	AU7885398 (A) 1997-08-19	1995-11-30
<input type="checkbox"/>	5. Plate-shaped holder housing for daily use and/or consumer articles					
	PAINSITH HERMANN [CH]	VICTORINOX AG [CH]	A45C11/00 A45D29/20	A45C11/00 A45D29/20 B29C85/02 (+5)	CN1207853 (A) 1999-02-10 CN1161059 (C) 2004-08-11	1995-11-30
<input type="checkbox"/>	6. PLATE-SHAPED HOLDER HOUSING FOR DAILY USE AND/OR CONSUMER ARTICLES					
		VICTORINOX AG IBACH [CH] PAINSITH HERMANN [AT]	A45C11/00 A45D29/20	A45C11/00 A45D29/20 B29C85/02 (+5)	DE29624203 (U1) 2001-04-26	1995-11-30

B29C65/02 EP1293144 (A3)
(+5) 2003-03-28
EP1293144 (B1)
2004-09-29

9. PLATE-SHAPED HOLDER HOUSING FOR DAILY USE AND/OR CONSUMER ARTICLES

★ Inventor: PAINSITH HERMANN [AT]	Applicant: VICTORINOX AG PAINSITH HERMANN	EC: <u>A45C11/00</u> <u>A45D29/20</u>	IPC: A45C11/00 A45D29/20 B29C65/02 (+5)	Publication info: ES2208767 (T3) 2004-06-16 ES2208767 (T5) 2007-03-16	Priority date: 1995-11-30
---	---	---	---	---	------------------------------

10. PLATE-SHAPED HOLDER HOUSING FOR DAILY USE AND/OR CONSUMER ARTICLES

★ Inventor: PAINSITH HERMANN [AT]	Applicant: PAINSITH HERMANN VICTORINOX AG	EC: <u>A45C11/00</u> <u>A45D29/20</u>	IPC: A45C11/00 A45D29/20 B29C65/02 (+5)	Publication info: ES2230442 (T3) 2005-05-01	Priority date: 1995-11-30
---	---	---	---	---	------------------------------

11. Card-shaped storage case for articles of daily use and/or consumer articles.

★ Inventor: PAINSITH HERMANN	Applicant: VICTORINOX AG [CH] PAINSITH HERMANN	EC: <u>A45C11/00</u> <u>A45D29/20</u>	IPC: A45C11/00 A45D29/20 B29C65/02 (+5)	Publication info: HK1017592 (A1) 2005-02-25	Priority date: 1995-11-30
---------------------------------	--	---	---	---	------------------------------

12. PLATE-SHAPED HOLDER HOUSING FOR DAILY USE AND/OR CONSUMER ARTICLES

★ Inventor:	Applicant:	EC: <u>A45C11/00</u> <u>A45D29/20</u>	IPC: A45C11/00 A45D29/20 B29C65/02 (+4)	Publication info: JP2000501003 (A) 2000-02-02 JP4098360 (B2) 2008-06-11	Priority date: 1995-11-30
-------------	------------	---	---	---	------------------------------

13. Plate-shaped holder housing for daily use and/or consumer articles

★ Inventor: PAINSITH HERMANN [AT]	Applicant: VICTORINOX AG [CH]	EC: <u>A45C11/00</u> <u>A45D29/20</u>	IPC: A45C11/00 A45D29/20 B29C65/02 (+4)	Publication info: US6044967 (A) 2000-04-04	Priority date: 1995-11-30
---	----------------------------------	---	---	--	------------------------------

14. Card-shaped storage case for articles of daily use and/or consumer articles

★ Inventor: PAINSITH HERMANN [AT]	Applicant: VICTORINOX AG [US]	EC: <u>A45C11/00</u> <u>A45D29/20</u>	IPC: A45C11/00 A45D29/20 B29C65/02 (+4)	Publication info: US6257405 (B1) 2001-07-10	Priority date: 1995-11-30
---	----------------------------------	---	---	---	------------------------------

15. Card-shaped storage case for articles of daily use and/or consumer articles

★ Inventor: PAINSITH HERMANN [AT]	Applicant: VICTORINOX AG [US]	EC: <u>A45C11/00</u> <u>A45D29/20</u>	IPC: A45C11/00 A45D29/20 B29C65/02 (+8)	Publication info: US2001047946 (A1) 2001-12-06 US6527112 (B2) 2003-03-04	Priority date: 1995-11-30
---	----------------------------------	---	---	--	------------------------------

Acesso a publicações
 integrais de diversos
 países, incluindo
 publicações de
 pedidos BR

About Espacenet Other EPO online services

Search Result list My patents list (0) Query history

EP0957704 (B2) → Family page 1 → US8044967 (A)

- US6044967 (A)
- Bibliographic data
- Description
- Claims
- Mosaics
- Original document**
- Cited documents
- Citing documents
- INPADOC legal status
- INPADOC patent family

Quick help

- [What happens if I click on "In my patents list"?](#)
- [What happens if I click on the "EP Register" button?](#)
- [How can I maximise the page view?](#)
- [How can I download documents?](#)

Original document US6044967 (A) — 2000-04-04

In my patents list Previous 13 / 17 Next EP Register Report data error Print

Plate-shaped holder housing for daily use and/or consumer articles

Page 1/43 Abstract Bibliography Maximise Download



US006044967A

United States Patent [19] **Patent Number: 6,044,967**
Painsith [45] **Date of Patent: Apr. 4, 2000**

[54] PLATE-SHAPED HOLDER HOUSING FOR DAILY USE AND/OR CONSUMER ARTICLES

[75] Inventor: **Hermann Painsith**, Klagenfurt, Austria
 [73] Assignee: **Victorinox AG**, Ibach, Switzerland
 [21] Appl. No.: **09/077,482**
 [22] PCT Filed: **Dec. 2, 1996**
 [86] PCT No.: **PCT/AT96/00238**
 § 371 Date: **May 29, 1998**
 § 102(c) Date: **May 29, 1998**
 [87] PCT Pub. No.: **WO97/19856**
 PCT Pub. Date: **Jun. 5, 1997**

[30] Foreign Application Priority Data
 Nov. 30, 1995 [AT] Austria 1961/95
 [51] Int. Cl.⁷ **B65D 69/00**
 [52] U.S. Cl. **206/234; 206/37; 206/349**
 [58] Field of Search 206/216, 234,
 206/38, 38.1, 235-241, 349, 37, 37.1, 37.4,
 37.6

[56] References Cited
U.S. PATENT DOCUMENTS
 5,467,871 11/1995 DeField 206/37.1
 5,621,936 4/1997 Penaligon et al. 206/234

FOREIGN PATENT DOCUMENTS

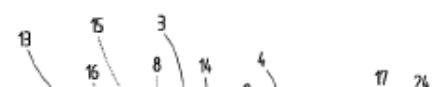
739628 1/1933 France .
 2656799 A1 7/1991 France .
 3843303 A1 7/1989 Germany .
 3827536 C1 11/1989 Germany .
 2 146 623 4/1985 United Kingdom .
 WO94/29083
 A2 12/1994 WIPO .

Primary Examiner—Paul T. Sewell
Assistant Examiner—Luan K. Bui
Attorney, Agent, or Firm—Alston & Bird LLP

[57] ABSTRACT

The invention relates to a card-shaped storage case (1) made of metal or plastic with at least one internal storage compartment (8) for at least one article, which is defined by a base plate (6) and at least in sections by a cover plate (7) of the storage case (1) running parallel to this, wherein several storage compartments (8) at least partially separate from one another are arranged in the storage case (1) in a plane running parallel to the base plate (6) and/or cover plate (7) and are constructed to receive articles in the form of articles of daily use (9) and/or consumer articles and are also accessible from the outside via storage openings (23), and the storage openings (23) are arranged in at least one of the longitudinal side faces (4) and/or transverse side faces (5) preferably running perpendicular to the base plate (6) and/or cover plate (7).

40 Claims, 26 Drawing Sheets



Fontes de Informações Sobre Decisões, Jurisprudência

- EPO - Case Law and Appeals
 - <http://www.epo.org/law-practice/case-law-appeals.html>
- Blogs, Sites...
 - www.jusbrasil.com.br
 - www.ipwatchdog.com
 - www.patentdocs.org
 - Etc.
- Revista da ABPI

Basic search - board of appeal decisions database

Advanced search - board of appeal decisions database

Recent decisions

Enlarged Board of Appeal

Case Law of the Boards of Appeal

Business distribution scheme

Case Law from the Contracting States to the EPC

Case law and appeals



Print 

See also

→ [Check the calendar of oral proceedings.](#)

Find out more about the boards of appeal - their structure, organisation and what they do.

→ [Boards of appeal](#)

Read about a proposal to give the EPO's boards of appeal organisational autonomy and a judicial function.

Organisational autonomy of the boards of appeal

→ [Standing Advisory Committee before the EPO \(SACEPO\)](#)

→ [European Round-Table on Patent Practice \(EUROTAB\)](#)

The boards of appeal and associated administrative services are integrated into the organisational structure of the EPO as Directorate-General 3. They are independent from the Office in their decisions and are bound only by the European Patent Convention (EPC).

The boards of appeal decisions database

Comprehensive texts of each decision of the EPO boards of appeal contained in the database (since 1979). The decisions are available in the language of the proceedings (English, French or German).

- [Basic search engine](#)
- [Advanced search engine](#)
- [Recent decisions](#)

Enlarged Board of Appeal

- [Pending referrals \(Art. 112 EPC\)](#)
- [Decisions sorted by number \(Art. 112 EPC\)](#)
- [Pending petitions for review \(Art. 112a EPC\)](#)
- [Decisions on petitions for review \(Art. 112a EPC\)](#)

Texts related to appeal proceedings

- [Business distribution scheme](#)
- ↳ [Information from the Boards of Appeal including rules of procedure](#)

Website updates

16.11.2012
[Enlarged Board of Appeal: new petition for review \(R 17/12\)](#)

8.11.2012
[Enlarged Board of Appeal: new decisions on petition for review \(R 20/11 and R 21/11\)](#)

2.10.2012
[Enlarged Board of Appeal: new decision on petition for review \(R 2/12\)](#)

→ [Updates archive](#) [RSS: appeals](#) 

Case law

A substantial body of case law on the European Patent Convention has developed since the first decision of a board of appeal was handed down in 1979.

- [Case Law of the Boards of Appeal \(sixth edition 2010\)](#)
- ↳ [EPO Board of Appeal Case Law 2011 \(OJ Special edition 2012\)](#)
- ↳ [EPO Board of Appeal Case Law 2010 \(OJ Special edition 2/2011\)](#)
- ↳ [EPO Board of Appeal Case Law 2009 \(OJ Special edition 2/2010\)](#)
- [Recent decisions](#)

[email a friend](#)

[bookmark or share](#)

HOT Items

- 02/01: The EPO's legal status file adds Slovakian data.
- 01/19: Google updates Google Scholar with legal opinion and journal search options.
- 01/11: The EPO announces addition of JP citations to DOCDB.
- 01/07: ChemAxon search platform JChem gains access to Thomson Reuters chemical IP Data Feeds including Markush Structures and patent data.
- 12/30: Online Public Access Prototype search system launched by the US National Archives.
- 12/14: Patent Lens Report fully reviewed and updated!

WELCOME TO INTELLOGIST!

To network with our international community of patent info pros, please [create an account](#).

For a list of our current members, see our

[Click here to read the Intellogist Blog!](#)

[Follow us on Twitter!](#)

Search System Reports

See detailed information on search systems

Interactive Patent Coverage Map

Click on map to find patent search systems

Quick Table Comparisons

Delphion	Dialog	esp@cenet	PatBase
Yes	No	Yes	No
No	Yes	No	Yes

Quickly compare patent search systems

Best Practices in Prior Art Searching

Collaborate on prior art search practices

Resource Finder

- [abinit.org](#)
- [chemsources.com](#)
- [chemnetbase.com](#)
- [lupac.org](#)

Find prior art resources by technical field

Please Support Our Sponsor:

SIEMENS WATER TECHNOLOGIES IS USING THOMSON INNOVATION TO DO JUST THAT.

Legal & Technical Translations

We speak your language (and theirs)

专利 [Learn more](#)

INTELLOGIST CONSULTING SERVICES

CUSTOMIZED EXPERT IP GUIDANCE

Patent Analysis

Put your IP to work

[Learn more](#)

Portal Periódicos CAPES

http://www.periodicos.capes.gov.br



BUSCA

Buscar assunto

Buscar periódico

Buscar livro

Buscar base

INSTITUCIONAL

Histórico

Missão e objetivos

Quem participa

Documentos

Estatísticas de uso

ACERVO

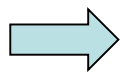
NOTÍCIAS

SUPORTE

Treinamentos

Materiais didáticos

Web TV



BUSCA

Assunto

BUSCAR ASSUNTO

Inserir termo

Enviar

Periódico

Livro

Base

Apesar do Portal realizar uma busca em qualquer idioma, sugere-se que sejam utilizados termos em inglês considerando que a literatura científica é em sua maioria publicada em inglês. Isso aumenta o número de resultados recuperados. Entretanto, nada impede que outros idiomas sejam utilizados. Busca avançada

DESTAQUES



Notícias

Aparência de Plutão fascina cientistas

Artigo publicado pelo periódico Nature, disponibilizado pelo Portal de Periódicos, fala sobre características surpreendentes, como o "coração de Plutão" - mancha brilhante com alta concentração de monóxido de carbono congelado

Um dos destaques na mídia especializada nas últimas semanas é a representatividade de Plutão no universo, apesar de ser considerado um



Portal Periódicos CAPES

http://www.periodicos.capes.gov.br



Acesso à informação

Participe

Serviços

Legislação

Canais

[Ir para o conteúdo](#) [Ir para o menu](#) [Ir para a busca](#) [Ir para o rodapé](#)

[MEU ESPAÇO](#) [ACESSIBILIDADE](#) [ALTO CONTRASTE](#) [MAPA DO SITE](#)

Portal de

Periódicos

CAPES/MEC

[Perguntas frequentes](#) | [Contato](#)

[PÁGINA INICIAL](#) > [ACERVO](#)



BUSCA

[Buscar assunto](#)

[Buscar periódico](#)

[Buscar livro](#)

[Buscar base](#)

INSTITUCIONAL

[Histórico](#)

[Missão e objetivos](#)

[Quem participa](#)

[Documentos](#)

[Estatísticas de uso](#)

ACERVO

[NOTÍCIAS](#)

[SUPORTE](#)

[Treinamentos](#)

[Materiais didáticos](#)

[Web TV](#)

Acervo

O Portal de Periódicos da Capes oferece acesso a textos completos disponíveis em mais de 37 mil publicações periódicas, internacionais e nacionais, e à a diversas bases de dados que reúnem desde referências e resumos de trabalhos acadêmicos e científicos até normas técnicas, patentes, teses e dissertações dentre outros tipos de materiais, cobrindo todas as áreas do conhecimento. Inclui também uma seleção de importantes fontes de informação científica e tecnológica de acesso gratuito na web. Para verificar a disponibilidade de acesso a determinado conteúdo pelo Portal, realize uma busca pelas opções abaixo:

Áreas de conhecimento

Todas as áreas do conhecimento

Termo

Inserir Termo

Filtrar

Exibindo 1 a 10 de 259 registros

< 1 2 3 4 5 6 7 >

19.09.13
03h09



19th Century Collections Online - NCCO (Gale)

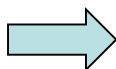
A assinatura pelo Portal de Periódicos da Nineteenth Century Collections Online da Gale/Cengage Learning pelo contrato Gale Collection Online I permite acesso gratuito a todos os bras...

27.04.04
03h04



Abstracts in New Technology & Engineering (ANTE)

O Portal de Periódicos da CAPES pelo contrato Proquest disponibiliza a base de dados de referências e resumos Abstracts in New Technology & Engineering - ANTE. A Abstracts in New T...



Portal Periódicos CAPES

<http://www.periodicos.capes.gov.br>

Web of Science

Disponível desde 19.10.00

Base de dados referencial com resumos em todas as áreas do conhecimento.

A base referencial multidisciplinar, Web of Science, que está integrada à base ISI Web of Knowledge. Oferece ferramentas para análise de citações, referências, índice h, permitindo análises bibliométricas. Cobre aproximadamente 12.000 periódicos. A assinatura deste conteúdo, oferece a possibilidade de consulta a 5 coleções: Science Citation Index Expanded (SCI-EXPANDED) - com disponibilidade de acesso a registros desde 1945 até o presente; Social Sciences Citation Index (SSCI) - com disponibilidade de acesso a registros desde 1956 até o presente; Arts & Humanities Citation Index (A&HCI) - com disponibilidade de acesso a registros desde 1975 até o presente; Conference Proceedings Citation Index- Science (CPCI-S) - com disponibilidade de acesso a registros desde 1990 até o presente e Conference Proceedings Citation Index - Social Science & Humanities (CPCI-SSH) - com disponibilidade de acesso a registros desde 1990 até o presente.

<http://apps.webofknowledge.com/>



Portal Periódicos CAPES

<http://www.periodicos.capes.gov.br>

Derwent Innovations Index (DII)

Disponível desde 22.10.09

Base de dados de patentes nas áreas de engenharia química, elétrica, eletrônica e mecânica.

Integrada à plataforma ISI Web of Knowledge, da Thomson Reuters, a Derwent Innovations Index (DII) é uma base de dados que possui referências e resumos de patentes com links para documentos em texto completo, se disponíveis, além de referências relacionadas nas áreas de: engenharia química, elétrica, eletrônica e mecânica. O período disponível para acesso é de 1966 até o presente.

http://wokinfo.com/products_tools/multidisciplinary/dii/



Portal Periódicos CAPES

<http://www.periodicos.capes.gov.br>

Scopus

Disponível desde 13.01.06

The logo for SCOPUS, featuring the word "SCOPUS" in a bold, blue, sans-serif font. The letter "O" is stylized with a white dot in the center.

Base de dados referencial nas áreas de Ciências Biológicas, Ciências da Saúde, Ciências Físicas e Ciências Sociais.

Oferece acesso a base referencial, da Editora Elsevier, que indexa títulos acadêmicos revisados, títulos de acesso livre, anais de conferências, publicações comerciais, séries de livros, páginas web de conteúdo científico(reunidos no Scirus) e patentes de escritórios. Dispõe de funcionalidades de apoio à análise de resultados(bibliometria), como identificação de autores e filiações, análise de citações, análise de publicações e índice H. Cobre as áreas de Ciências Biológicas, Ciências da Saúde, Ciências Físicas e Ciências Sociais. Período de acesso desde 1823 até o presente.

<http://www.scopus.com/home.url>

Portal Periódicos CAPES

<http://www.periodicos.capes.gov.br>

CAB Abstracts

Disponível desde 01.12.00

Base de dados referencial nas áreas de Ciências Agrárias, Ciências Biológicas e Ciências Ambientais.

Oferece acesso a base de dados referencial CAB Abstract que é acessada através da plataforma Ovid. É uma base de dados compilada pela CAB INTERNATIONAL que contém resumos de aproximadamente 9.000 periódicos nas áreas de agricultura, agronomia, solos, pesticidas, horticultura, florestas, veterinária, fertilizantes, genética, meio ambiente, biologia e nutrição. Disponibilidade de acesso desde 1990 até o presente.

<http://www.ovid.com/site/catalog/DataBase/31.jsp>



CABI compendia

Disponível desde 23.06.08

Enciclopédias interativas que reúnem informação científica nas áreas de agricultura, sistemas agroflorestais, pecuária, aquacultura.

Oferece acesso a 5 enciclopédias interativas da CABI compendia que reúnem uma grande variedade de informação científica nas áreas de ciências agrárias e ambientais. Cada Compêndio inclui informações de especialistas, editado e compilado por uma organização científica independente. São elas: Animal Health and Production Compendium; Aquaculture Compendium; Crop Protection Compendium; Forestry Compendium; e Invasive Species Compendium.

<http://www.cabi.org/default.aspx?site=170&page=1030>



Portal Periódicos CAPES

<http://www.periodicos.capes.gov.br>

Compendex Engineering Index (Ei)

Disponível desde 23.10.09

Base de dados referencial com registros nas áreas de Engenharia.

Oferece acesso a base referencial, Compendex Engineering Index, que publica mais de 10 milhões de registros e referências de mais de 5.600 periódicos e anais de conferências com disponibilidade desde 1969 até o presente. As publicações cobrem as áreas de Engenharia, Energia, Ciência da Computação, Robótica e Controle.

<http://www.engineeringvillage2.org/controller/servlet/Controller?CID=quickSearch&database=1>



Portal Periódicos CAPES

<http://www.periodicos.capes.gov.br>

INSPEC

Disponível desde 01.01.04

Acesse base de dados referencial da Institution of Engineering and Technology (IET).

A base INSPEC possui cobertura abrangente nos campos da eletrônica, ciência da computação, física, elétrica, controle, produção e engenharia mecânica. Disponibiliza resumos de artigos selecionados de cerca de 4.000 revistas científicas e técnicas, cerca de 2.500 conferências, bem como livros, relatórios e dissertações. Período disponível online desde 1969 até o presente.

<http://ovidsp.ovid.com/ovidweb.cgi?T=JS&NEWS=n&CSC=Y&PAGE=main&D=insz>



Portal Periódicos CAPES

<http://www.periodicos.capes.gov.br>

SciFinder

Disponível desde 03.01.05

Ferramenta de pesquisa do Chemical Abstracts Service (CAS), a SciFinder é um serviço de indexação de periódicos científicos na área de Química Orgânica, Química Inorgânica, Físicoquímica, Química Analítica, Engenharia Química, Processamento de Petróleo, Tintas, Revestimentos, Engenharia Sanitária, Poluição do Ar e da Água, Tratamento de Resíduos, Ciências Ambientais, Farmacologia, Toxicologia, Medicina Experimental, Biologia Celular e Molecular, Genética, Genoma, Proteoma, Bioquímica, Microbiologia, Enzimologia, Alimentos, Física, Química e Engenharia de Materiais, Polímeros, Elastômeros, Ligas, Cerâmica. Agrega informações de mais de 61 autoridades de patentes incluindo patentes anteriores a 1907. São seis bases de dados disponíveis:

- Caplus (1907-presente);
- Registry (1907-presente);
- Chemical Reactions (1840-presente);
- Substâncias Químicas Regulamentadas (1778-presente);
- CHEMCATS;
- Medline (Saúde).

<http://scifinder.cas.org>



Portal Periódicos CAPES

<http://www.periodicos.capes.gov.br>

Science Direct

Disponível desde 01.01.01

Acesso a textos completos em diversas áreas, além de arquivos multimídias, periódicos, livros eletrônicos e enciclopédias.

Oferece acesso a base Science Direct que permite acesso à coleção Freedom Collection. Esta coleção contém cerca de 1.800 periódicos em texto completo publicados pela Elsevier em todas as áreas do conhecimento, mas com foco nas áreas de ciências, tecnologia e medicina. A cobertura de texto completo dos periódicos da coleção está disponível desde 1995 até o presente.

<http://www.info.sciverse.com/sciencedirect>



Fontes de Informações Patentárias (Comerciais)



- Questel FAMPAT
- Derwent WPI
- Chemical Abstracts CAPLUS
- Etc...
- Intellogist (www.intellogist.com)

Fontes de Informações Patentárias (Comerciais)



- Questel Orbit
- Innography
- PatBase
- Derwent Innovations Index
- Thomson Innovation
- Total Patent
- Etc...

- Intellogist (www.intellogist.com)

Ex. Questel Orbit

Formulário de busca intuitivo com múltiplos campos e possibilidades de combinação.

The screenshot displays the Questel Orbit patent search interface. The main search area is titled "General search" and contains several sections for filtering results:

- Keywords:** Two search terms are entered: "effervescent" and "tablet". Each term has a dropdown menu for field selection (e.g., "Title, Abstract, Key Content, Claims") and a truncation symbol (three dots).
- Classifications:** A dropdown menu is set to "and" and "IPC". A "Browse" button is visible next to the input field.
- Names:** Fields for "Assignee (Original or Current)", "Inventor", and "Representative" are present. A "Corporate Tree" button is also visible.
- Numbers, Dates & Country:** Fields for "Publ. number", "Date" (set to "No Restriction"), and "Publication country" (with examples like "US, EP").
- More fields:** A dropdown menu is set to "Abstracts".
- Restriction:** A section for applying search restrictions.

At the bottom of the search form, there are four buttons: "Search", "Show the cmd. line", "Create script", and "Clear".

Below the search form, a text box displays the generated search command: `((effervescent)/BI/SA/CLMS AND (tablet))`. This command uses parentheses for grouping, slashes for field indexing, and the word "AND" for combining terms.

Two callout boxes provide additional information:

- The first callout points to the search command and states: "Geração automática de linha de comando avançada editável" (Automatic generation of advanced, editable command line).
- The second callout points to the search command and states: "Possibilidade de buscas avançadas com uso de conectores de proximidade, múltiplos parênteses, indexadores de campos e truncagem à direita, à esquerda e no meio de termos de busca" (Possibility of advanced searches with use of proximity connectors, multiple parentheses, field indexers and truncation to the right, to the left and in the middle of search terms).

Ex. Questel Orbit

Formulário de busca intuitivo com múltiplos campos e possibilidades de combinação.

Keywords

Title

Title

Title, Abstract

Title, Abstract, Claims

Title, Abstract, Key Content

Title, Abstract, Key Content, Claims

Claims

Description

Independent Claims

Key Content

Concepts

Full Text

Restriction

Limit to the following legal status:

No restriction

No restriction

Patent in force

Opposition

Licensing

Term right extended

Ownership

Entry into national phase

Not in force

Names

Assignee (Original or Current)

Assignee (Original or Current)

Current Assignee

Original Assignee

Classifications

IPC

IPC

ECLA

ICO

US (main)

US (main & x-ref)

FI

F-Terms

Numbers, Dates & Country

Publ. number

Publ. number

Appl. number

Priority number

Application or Priority number

More fields

Abstracts

Advantages over prior art drawbacks

Object of invention

Citations, all

Citations, non patent References

Designated States

FamPat Family Number

PCT Publication number

PCT Application Nbr

Patent Assignee Country

Patent Assignee US State

Inventor Country

Inventor US State

Representative Country

US and FR Filing Details

Other Publication Dates

First Date of Pub.Appl.

First Date of Issued Grant

Patent Date, last pub.

First Family's Priority Date

EPO Dutch Class

Number of Patents in the FamPat Family

Number of Priorities in the FamPat Family

USPTO Examiner or US Representative

Independant claim number (US)

Number of claims (US)

Number of drawings (US)

Number of figures (US)

US Case ID

Abstracts

Ex. Questel Orbit

Orbit.com

Patents

Full Text merged in families (FamPat) Bibliography by country (PlusPat) Full Text by publication

Search Step	Result(s)	Query	Assistant	Source	Action
4	2	3 AND BR/PC	Search history	FAMPAT	Show results Modify Save Alert Delete
3	179	1 AND 2	Search history	FAMPAT	Show results Modify Save Alert Delete
2	108077	(KEYBOARD)/BI/SA	General search	FAMPAT	Show results Modify Save Alert Delete
1	52969	(COLLAPSIBLE)/BI/SA	General search	FAMPAT	Show results Modify Save Alert Delete

Searches

- General search
- Number search
- Citation search

My Session

- Search history
- Search results
- Cost estimator

Past Sessions

- Previous History
- Previous Analysis

My Searches

- My saved searches
- My alerts

My Lists

- Quicklist (0)

Combine strategies, E.g.: (1 or 2) not 3, 1 and (phone+)

3 and br/pc

Search

Possibilidade de gravação de buscas para posterior execução

Histórico de busca automaticamente gerado e pesquisável

Ex. Questel Orbit

Painéis de visualização em paralelo e múltiplas opções de visualização permitem aumento de produtividade na avaliação dos documentos

Orbit.com | Display | Add to | Export | Top | Citations | Translate | Compare | Save | Alert | Analyse

181 results for (COLLAPSIBLE AND KEYBOARD)/BI/SA | Select all results, Clear selection | 100 results are selected. | Sort by relevance

Search Patents... | Searches | General search | Number search | Citation search | My Session | Search history | Search results | Cost estimator | Past Sessions | Previous History | Previous Analysis | My Searches | My saved searches | My alerts | My Lists | Quicklist (0)

#	Title	Original or current assignee	Publ. number	Pr. Date
1.	MULTI-PIECE STAND FOR MOBILE COMPUTING DEVICE	BELKIN	WO2011047217	2009-10-14
2.	Electromagnetic isolation chamber for accurately manipulating devices therein	LEEGATE GARY CONRAD; LEEGATE ROLLAND STEPHEN	US2011031009	2009-08-04
3.	Bedtime Computer Table	TCHOLAKOV STAYKO	US2010300334	2009-05-29
4.	HANDHELD ELECTRONIC DEVICE AND KEYBOARD HAVING MULTIPLE-FUNCTION KEYS	FYKE STEVEN HENRY	US2010271309	2004-02-24
5.	DETECTING KEY ACTUATION IN A KEYBOARD	OLODORT ROBERT; TANG JOHN; TURCHIK RANDY	US2010271310	1997-11-12
6.	(U3) Collapsible keyboard		JP3092668	2002-09-09
7.	Improvements in collapsible typewriting machines	REMINGTON TYPEWRITER	US1467995	1922-01-31
8.	Typewriting machine	REMINGTON TYPEWRITER	US1468274	1922-03-16
9.	HEIGHT-ADJUSTABLE EQUIPMENT STAND	JANSSEN RAINER	WO2009124523	2008-04-08
10.	COLLAPSIBLE KEYBOARD	GIGA BYTE TECHNOLOGY; GYGA BYTE TECHNOLOGY	WO2009100607	2008-01-31
11.	Split type laptop type collapsible soft keyboard	XU CHEN	CN101135932	2007-08-14
12.	Foldable electronic seat label	SHANGHAI BEIDA FOUNDERTECH COM	CN200993853	2006-12-30
13.	Portable Computer Stand	LEUNG CHILY C	US2008142662	2006-12-16
14.	Multimedia digital book	LIU JIANSHENG	CN200976144	2006-11-24
15.	Bar, folding dual-purpose handset	XU GANGBIN	CN200944615	2006-08-22
16.	ADAPTABLE BI-FOLD SCRAPBOOK AND CRAFT WORKSTATION	ENSIGN INTERNATIONAL	WO2007146134	2006-06-07
17.	FOLDING ELECTRONIC PIANO COMPRISING KEYBOARD-STIFFENING MEANS	PARENTI RAOUL; RAOUL PARENTI	WO2006114531	2006-04-28
18.	ELECTRONIC DEVICE FOR CONDUCTING PROGRAMMED FUNCTIONS (VARIANTS) AND METHOD FOR INPUTTING COMMANDS IN SUCH A DEVICE	LG ELECTRONICS	RU2319997	2005-12-30
19.	Keyboard and its input method	LENOVO	CN100447718	2005-12-23
20.	DASHBOARD PROVIDED WITH FOLDABLE TABLE	RENAULT	WO2007060352	2005-11-28
21.	COLLAPSIBLE PROJECTION ASSEMBLY	CTS; MOTOROLA	WO2006118760	2005-04-29
22.	Ventilation support for laptop computers	SAAD DAVID J	US2006243678	2005-04-27
23.	HANDHELD ELECTRONIC DEVICE PROVIDING FEEDBACK TO FACILITATE NAVIGATION AND THE ENTRY OF INFORMATION, AND ASSOCIATED METHOD	RESEARCH IN MOTION	US2010315344	2005-02-09

Page 1 of 2 | Record 10 of 181

Preview | Drawings | Image | Key Content | Concepts | F | +

COLLAPSIBLE KEYBOARD

图 2

AB
(WO2009100607)
A collapsible keyboard includes a keyboard body (1), a hand rest (2) and at least one connecting component (3). The keyboard body (1) has a connecting side (10) towards the side of the user. The hand rest (2) has a bearing surface (20), a first side (22) and a second side (23), the bearing surface (20) supporting the wrist of the user, the first side (22) facing the connecting side (10) of the keyboard body (1), the second side (23) locating the reverse side of the first side (22). The connecting component (3) is set between the keyboard body (1) and the hand rest (2), and the two ends of the connecting component (3) are connected rotatably to the keyboard body (1) and the hand rest (2) respectively, for folding the hand rest (2) to the rear of the keyboard body (1). The second side (23) is engaged with the rear of the keyboard body (1), and the connecting side (10) of the keyboard body (1) and the first side (22) of the hand rest (2) are formed a support plane, for erecting the keyboard body (1) in a manner that the connecting side (10) faces downwards. The collapsible keyboard can be stably and vertically folded to reduce the table space occupation.

IN LIN CHENHSING
PA GIGA BYTE TECHNOLOGY
GYGA BYTE TECHNOLOGY
PAH (WO2009100607)
(A1) GYGA BYTE TECHNOLOGY CO LTD (CN); LIN CHENHSING (CN)
(CN201145884U)
(Y) GIGA BYTE TECH CO LTD (CN)
PA0 LIN, Chenhsing / No. 6, Bau Chiang Road, Hsin-Tien (CN) (only US)
PP (WO2009100607)

Displaying records 1 - 100 of 181

Ex. Questel Orbit

Possibilidade de edição dos termos grifados e gravação de perfis para uso posterior.

The screenshot displays the Questel Orbit patent search interface. The main window shows a patent record for "FOLDING KEYBOARD FOR A PERSONAL DIGITAL ASSISTANT" (WO200208877). The abstract describes a folding keyboard for personal digital assistants that is compact and easy to use. A "Highlight Wizard" dialog box is open, allowing the user to create or edit search profiles. The dialog box has a "Highlight" section with the instruction "Fill in the form to highlight specific terms." and a "My profiles:" section with a dropdown menu set to "Last search". There are four profiles listed, each with a color-coded square and a search term: a yellow profile for "collaps+, fold+, retract+" (example: "bicycl+"), a pink profile for "keyboard" (example: "+digest+"), a grey profile for an empty field (example: "+inflammatory"), and a cyan profile for an empty field (example: "cold,cool+,freez+"). There are also two more profiles with empty fields and examples "polymeri+ation" and "brake disc". The dialog box has "Clear", "Apply", "Ok", and "Cancel" buttons.

Patent Record:

Title: FOLDING KEYBOARD FOR A PERSONAL DIGITAL ASSISTANT

Pub. No.: WO200208877

Abstract: Prior collapsible keyboards for personal digital assistants are overly complex and large. The present invention provides a folding keyboard for a personal digital assistant which folds up simply and in a small size and which is useful for standard typists. It is divided into two halves hingedly connected along a fold line. While the central or home row keys are standard size, the other two rows of keys are of reduced transverse dimension and are preferably so shaped as to allow a touch typist to use existing movements without missing the keys of reduced size.

Inventor: KATZ MICHAEL

Applicant: カッツ、マイケル

IPC Class.: G06F 016/00

Pub. Date: 08.05.2002

Pub. No.: WO 02/08877 A2

Int. Cl.: G06F 016/00

Agent: GREEN, Bruce, M., Oyen Wiggs Green & Mutsaers, 601 West Cordova Street #480, Vancouver, British Columbia V6B 1G1 (CA).

Designated States: AE, AG, AL, AM, AT, AU, AZ, BA, BB, BG, BR, BY, BZ, CA, CH, CN, CO, CR, CU, CZ, DE, DK, DM, DZ, EC, EE, EG, ES, FI, FR, GB, GR, GT, HK, HU, IL, IN, IS, JP, KG, KP, KR, KZ, LC, LK, LR, LS, LT, LU, LV, MA, MD, MG, MK, MN, MW, MX, MY, MZ, NA, NZ, PL, PT, RO, RU, SD, SE, SG, SI, SK, SL, SM, SV, TC, TD, TM, TR, TT, TZ, UA, UG, US, UZ, VN, YU, ZA, ZW.

Abstract: Prior collapsible keyboards for personal digital assistants are overly complex and large. The present invention provides a folding keyboard for a personal digital assistant which folds up simply and in a small size and which is useful for standard typists. It is divided into two halves hingedly connected along a fold line. While the central or home row keys are standard size, the other two rows of keys are of reduced transverse dimension and are preferably so shaped as to allow a touch typist to use existing movements without missing the keys of reduced size.

Figure 1: A perspective view of a folding keyboard in its unfolded state, showing a central home row of keys and two rows of keys on either side that are hinged to the central row. The keyboard is labeled with various reference numerals (10, 12, 13, 14, 15, 16, 17, 18, 19, 20, 21, 22, 23, 24, 25, 26, 27, 28, 29, 30, 31, 32, 33, 34, 35, 36, 37, 38, 39, 40, 41, 42, 43, 44, 45, 46, 47, 48, 49, 50, 51, 52, 53, 54, 55, 56, 57, 58, 59, 60, 61, 62, 63, 64, 65, 66, 67, 68, 69, 70, 71, 72, 73, 74, 75, 76, 77, 78, 79, 80, 81, 82, 83, 84, 85, 86, 87, 88, 89, 90, 91, 92, 93, 94, 95, 96, 97, 98, 99, 100).





Ex. Questel Orbit

Barra de rolagem mostra a localização dos termos grifados no texto integral

The screenshot displays the Questel Orbit web interface. On the left, a sidebar shows a list of patent records for a patent family (70 / 179 - Patent Family), including entries for JP2004513415 T, US6679639 B2, US6594142 B2, EP1305699 A2, US2002191999 A1, CA2366636 A1, PCT WO200208876 A2, PCT WO200208877 A2, US2002030965 A1, AU7225201 A, AU7562701 A, PCT WO200208877 A2, and PCT WO200208876 A2. Below this are links for 'Find similar patents', 'Find Inpadoc family', and 'Graph Inpadoc family'.

The main content area shows the details for patent (A2) **FOLDING KEYBOARD** FOR A PERSONAL DIGITAL ASSISTANT. The title is highlighted in yellow. The abstract text contains several terms highlighted in yellow: 'collapsible keyboards', 'folding keyboard', and 'fold line'. A vertical scrollbar on the right side of the text area is highlighted in purple, indicating the location of the highlighted terms in the full text.

Below the abstract, there is a table of 'Published As' records:

Publ. number	Pub. date	Appl. number	Appl. date	Publ. Stage	Links
PCT WO0208877	20020131			A2 -	   

Below the table, there are sections for 'AP' (WOCA0100983 20010718 [2001WO-CA00983]), 'PR' (US85015801 20010508 [2001US-0850158], US21912500P 20000719 [2000US-P219125]), 'FD' (US85015801 20010508 [2001US-0850158] : 8501580120010508 [2001US-0850158]), 'IC' (G06F-001/16), 'ICO' (T04M-001/02A2B4, T04M-001/725F1B), and 'ICAA' (G06F-003/02 [2006-01 A F I R M JP]; G06F-001/16 [2006-01 A - I R M EP]; H01H-013/702 [2006-01 A L I R M JP]; H04M-001/02 [2006-01 A - I R M EP]; H04M-001/23 [2006-01 A - I R M EP]).

At the bottom, it says 'Record 70 of 179'.

On the right side, a preview of the patent document is shown. It includes the title '(12) INTERNATIONAL APPLICATION PUBLISHED UNDER THE PATENT COOPERATION TREATY (PCT)', the International Publication Number 'WO 02/08877 A2', and the International Patent Classification 'G06F 1/16'. The abstract text is visible, and a vertical scrollbar on the left side of the preview is highlighted in purple, corresponding to the scrollbar in the main interface. Below the text is a technical drawing of a keyboard with numbered callouts (10, 12, 13, 14, 15, 20, 21, 22, 23, 24, 25, 26, 27, 28, 29, 30, 31, 32, 33, 34, 35, 36, 37, 38, 39, 40, 41, 42, 43, 44, 45, 46, 47, 48, 49, 50, 51, 52, 53, 54, 55, 56, 57, 58, 59, 60, 61, 62, 63, 64, 65, 66, 67, 68, 69, 70, 71, 72, 73, 74, 75, 76, 77, 78, 79, 80, 81, 82, 83, 84, 85, 86, 87, 88, 89, 90, 91, 92, 93, 94, 95, 96, 97, 98, 99, 100).

At the bottom right, it says 'Displaying records 1 - 100 of 179'.

Visualização em modo "Fulltext" permite leitura de descrição e visualização de figuras em paralelo

Ex. Questel Orbit

Possibilidade de ordenamento dos resultados por relevância

The screenshot shows the Questel Orbit interface with search results for '(collapsible)/BI/SA AND (keyboard)/BI/SA'. The results are sorted by relevance. A callout points to the 'Sort by relevance' option. Another callout points to the 'Legal Status' column in the detailed view, which is expanded to show the status for patent family AU7562701 A.

#	Title	Original or current assignee	Publ. number	Pr. Date	Date	Code	Action
51.	Collapsible keyboard	CHANGSHU SUNREX TECHNOLOGY	US6547463	2002-01-16	20020404	WO/AL [ADM;POS]	MD RU TJ TM AT BE CH CY DE DK ES FI FR GB GR IE IT LU MC NL PT SE TR BF BJ CF CG CI CM GA GN GQ GW ML MR NE SN TD TG
52.	WIRELESS KEYBOARD FOR HAND-HELD COMPUTERS	POCKETOP COMP, POCKETOP COMPUTER	WO03060681	2002-01-04	20020404	WO/A3 [EXM;POS]	International search report WO200208876 A3 20020404 [WO200208876]
53.	Collapsible keyboard	DARFON ELECTRONICS	US2003122690	2001-12-28	20020530	WO/DFPE [EXM]	REQUEST FOR PRELIMINARY EXAMINATION FILED PRIOR TO EXPIRATION OF 19TH MONTH FROM PRIORITY DATE (PCT APPLICATION FILED BEFORE 20040101)
54.	COLLAPSIBLE PORTABLE COMMUNICATION TERMINAL	FDK	JP2003198664	2001-12-28	20030102	WO/REG; DE/8642 [EN]	REFERENCE TO NATIONAL CODE DE: IMPACT ABOLISHED FOR DE - I.E. PCT APPL. NOT ENT. GERMAN PHASE DE: WIRKUNG WEGGEFALLEN FUER DE Corresponding cc: DE
55.	MECHANISM FOR UNFOLDING AND FOLDING OF FOLDING KEYBOARDS OF PORTABLE COMPUTERS AND SIMILAR DEVICES	KORSAKOV GRIGORU	WO2004006077	2001-12-11	20030903	WO/32PN [ADM;NEG]	EP: PUBLIC NOTIFICATION UNDER RULE 80 EPC, NOTIFIED IN THE EP BULLETIN COMMUNICATON PURSUANT TO RULE 69(1) EPC
56.	Collapsible keyboard	LITE ON TECHNOLOGY	US2003063939	2001-09-28	20031105	WO/122 [ENP;NEG]	EP: PCT APP. NOT ENT. EUROP. PHASE
57.	Collapsible keyboard	YAN HUEI SHIANG; YEN HUEY SHIANG	US2003048595	2001-09-10	20050606	WO/NENP [RLW]	NON-ENTRY INTO THE NATIONAL PHASE IN:Corresponding cc: JP
58.	Foldable keyboard work platform and carrying case		US2003034263	2001-08-17	AU7562701 A		
59.	Key switch	BEHAVIOR TECH COMPUTER	US2003029708	2001-08-10	Legal Status N/A		
60.	Collapsible keyboard	BEHAVIOR TECH COMPUTER	US2003030623	2001-08-10	Dead: US2002030965 A1, US6594142 B2		
61.	Collapsible/folding mini USB/MIDI keyboard controller		US2003019346	2001-07-27	20010508	US/API [EXM;POS]	FILING DETAILS US85015801 20010508 [2001US-0850158]
62.	POP-UP ELECTRONIC EQUIPMENT ENCLOSURE	LAPDOME	WO02000000	2001-06-06	20020314	US/A1 [EXM;POS]	First published patent application US2002030965 A1 20020314 [US2002030965]
63.	COLLAPSIBLE PANEL FOR AN ELECTRONIC DEVICE	BORUCKI GREGORY C; CECCHI MARINO; QUINN BRIAN P	US200104051618	2001-05-11	20030715	US/B2 [PIF;POS]	Granted patent as second publication US6594142 B2 20030715 [US6594142]
64.	Stroller with programmable information module	GERICO CHILDREN'S PRODUCTS CO	US200103132612	2001-05-09	20070904	US/FP-A [NEG;NIF]	EXPIRED DUE TO FAILURE TO PAY MAINTENANCE FEEEFFECTIVE DATE: 20070715
65.	Flat hanging computer mouse		US200102149905	2001-04-11	Dead: CA2366636 A1		
66.	Height-adjusting computer mouse button key		US200102148711	2001-04-11	20020104	CA/API [EXM;POS]	FILING DETAILS CA2366636 20020104 [2002CA-2366636]
67.	Portable computer mouse		US200102100398	2001-01-31	20021108	CA/A1 [EXM;POS]	Application laid open CA2366636 A1 20021108 [CA2366636]
68.	Ergonomic furniture	FARIA SABRINA ANN; LAWRENCE R C	GB2369565	2000-12-04	20070104	CA/FZDE-A [NEG;NIF]	DEAD
69.	Collapsible computer mouse pad		US2002117588	2000-10-04	Dead: US2002191999 A1, US6679639 B2		
70.	FOLDING KEYBOARD FOR A PERSONAL DIGITAL ASSISTANT	KATZ MICHAEL; MICHAEL KATZ; POCKETOP COMPUTERS	WO200208877	2000-07-19	20020626	US/API [EXM;POS]	FILING DETAILS US17916902 20020626 [2002US-0179169]
71.	Folding keyboard for a personal digital assistant	POCKETOP COMPUTERS	US2005025551	2000-07-19	First published patent application		
72.	Method and system for web management	EGRAIL	EP1172734	2000-07-12			
73.	Collapsible keyboard	DARFON ELECTRONICS	US2002003530	2000-07-05			
74.	Collapsible keyboard	ACER; DARFON ELECTRONICS	US2002001498	2000-07-01			
75.	Electronic device with collapsible display	IPG ELECTRONICS S03; PHILIPS	EP1193953	2000-06-30			

Visualização do "Legal Status" para cada família de patentes: Modo Textual

Ex. Questel Orbit

Orbit.com | Display | Add to | Export | Top | Citations | Translate | Compare | Save | Alert

179 results for ((collapsible)/BI/SA AND (keyboard)/BI/SA)

Google | Sort by relevance

#	Title	Original or current assignee	Publ. number	Pr. Date
51.	Collapsible keyboard	CHANGSHU SUNREX TECHNOLOGY	US6547463	2002-01-16
52.	WIRELESS KEYBOARD FOR HAND-HELD COMPUTERS	POCKETOP COMP, POCKETOP COMPUTER	WO03060681	2002-01-04
53.	Collapsible keyboard	DARFON ELECTRONICS	US2003122690	2001-12-28
54.	COLLAPSIBLE PORTABLE COMMUNICATION TERMINAL	FDK	JP2003198664	2001-12-28
55.	MECHANISM FOR UNFOLDING AND FOLDING OF FOLDING KEYBOARDS OF PORTABLE COMPUTERS AND SIMILAR DEVICES	KORSAKOV GRIGORU	WO2004006077	2001-12-11
56.	Collapsible keyboard	LITE ON TECHNOLOGY	US2003063939	2001-09-28
57.	Collapsible keyboard	YAN HUEI SHIANG; YEN HUEY SHIANG	US2003048595	2001-09-10
58.	Foldable keyboard work platform and carrying case		US2003034263	2001-08-17
59.	Key switch	BEHAVIOR TECH COMPUTER	US2003029708	2001-08-10
60.	Collapsible keyboard	BEHAVIOR TECH COMPUTER	US2003030623	2001-08-10
61.	Collapsible/folding mini USB/MIDI keyboard controller		US2003019346	2001-07-27
62.	POP-UP ELECTRONIC EQUIPMENT ENCLOSURE	LAPDOME	WO02098763	2001-06-06
63.	COLLAPSIBLE PANEL FOR AN ELECTRONIC DEVICE	BORUCKI GREGORY C; CECCHI MARINO; QUINN BRIAN P	WO2004051618	2001-05-11
64.	Stroller with programmable information module	GERICO CHILDREN PRODUCTS; GRACO CHILDRENS PRODUCTS	US2003132612	2001-05-09
65.	Flat hanging computer	HEWLETT PACKARD; HEWLETT PACKARD DEVELOPMENT	US2002149905	2001-04-11
66.	Height-adjusting collapsible mechanism for a button key	DARFON ELECTRONICS	US2002148711	2001-04-11
67.	Portable computer stand for a laptop computer		US2002100398	2001-01-31
68.	Ergonomic furniture	FARIA SABRINA ANN; LAWRENCE R C	GB2369565	2000-12-04
69.	Collapsible computer mouse pad		US2002117588	2000-10-04
70.	FOLDING KEYBOARD FOR A PERSONAL DIGITAL ASSISTANT	KATZ MICHAEL; MICHAEL KATZ; POCKETOP COMPUTERS	WO200208877	2000-07-19
71.	Folding keyboard for a personal digital assistant	POCKETOP COMPUTERS	US2005025551	2000-07-19
72.	Method and system for web management	EGRAL	EP1172734	2000-07-12
73.	Collapsible keyboard	DARFON ELECTRONICS	US2002003530	2000-07-05
74.	Collapsible keyboard	ACER; DARFON ELECTRONICS	US2002001498	2000-07-01
75.	Electronic device with collapsible display	IPG ELECTRONICS S03; PHILIPS	EP1193953	2000-06-30

Claims | Key Content | Fulltext | Legal Status | Timeline (beta)

Appl. Folding cellular telephone and digital assistant with

	01	02	03	04	05	06	07	08	09	10	11
Published As											
WO200208877	■	■	■	■	■	■	■	■	■	■	■
AU7225201	■	■	■	■	■	■	■	■	■	■	■
EP1305699	■	■	■	■	■	■	■	■	■	■	■
JP2004513415	■	■	■	■	■	■	■	■	■	■	■
WO200208876	■	■	■	■	■	■	■	■	■	■	■
AU7562701	■	■	■	■	■	■	■	■	■	■	■
US2002030965	■	■	■	■	■	■	■	■	■	■	■
CA2366636	■	■	■	■	■	■	■	■	■	■	■
US2002191999	■	■	■	■	■	■	■	■	■	■	■

■ Applied ■ Published, Restored ■ Granted, Extended ■ Rejected, Invalid
 ■ Expired, Revoked, Lapsed ■ Abandoned, Withdraw, Cancelled

Visualização do "Legal Status" para cada família de patentes: Modo Gráfico - "Timeline"

Page 3 of 8 | Record 70 of 179 | Displaying records 51 - 75 of 179

Ex. Questel Orbit

Buscas por citações por múltiplas famílias simultaneamente e em diversas categorias

The screenshot displays the Questel Orbit patent search interface. The search criteria are set to "179 results for ((COLLAPSIBLE)/B)". The results list includes:

- 1. Electromagnetic isolation chamber for accurately manipulating devices therein** (US2011031009) by ROLLAND STEPHEN. Description: An EMI shielded isolation chamber is provided, having an integral manipulator for manipulating electronic devices such as cell phones within the chamber, whereby a probe can be precisely positioned to selectively and directly actuate controls, switches, and keypads upon the devices anywhere in the chamber upon rotation of a probe tip. Extensible **collapsible** shielding boots are coupled between wall portions of the shielded chamber, adjacent a wall mounted manipulator support gimbal, and forward or rearward portions of the mechanical manipulator for preventing EMI signals from entering or leaving the shielded chamber. Alternatively, the gimbal constitutes the shielding device whereby a metallic hollow ball, slidably and rotatably supporting and containing the elongated manipulator, is mechanically biased snugly against a concave metallic member to block radiation from entering or leaving the shielded chamber. The probe tip is self-illuminated by an LED, thus providing illumination for the portion of the device being actuated.
- 2. Bedtime Computer Table** (US2010300334) by TCHOLAKOV STAYKO. Description: A bedtime computer table allows one to comfortably use a laptop computer or other portable electronic devices while reclining in bed or sofa. The bedtime computer table consists of a flat panel to support a laptop computer and a mouse, a set of **collapsible** leg panels that support said panel and reciprocal locking fixtures that set members at fixed positions. The bedtime computer table can be in folded or unfolded position. The bedtime computer table has some of the following functions: a) Protects user from heat and absorbs heat from a laptop computer. b) Organizes one's usage of laptop computer, computer **keyboard** and a mouse while staying in bed or sofa. c) Alleviates weight pressure from user's lap.
- 3. HANDHELD ELECTRONIC DEVICE AND KEYBOARD HAVING MULTIPLE-FUNCTION KEYS** (US2010271309) by FYKE STEVEN HENRY. Description: An improved handheld electronic device having an improved **keyboard** provides enhanced usability with fewer keys by enabling the keys to pivot slightly to provide multiple functions to the keys. The improved **keyboard** may, for example, include internal strips of conductive carbon that are disposed adjacent the keys and are electrically engageable with contacts on a printed circuit board. Specifically, when a key is pressed directly downward it collapses a single dome and connects together a set of primary contacts to provide a first function. When the key is pressed at the side thereof, the key pivots slightly, collapses the dome and connects together the primary contacts, and also engages a carbon strip with a pair of secondary contacts to connect together the secondary contacts, of all of which provide a second function. The **keyboard** may be configured to be of a QWERTY configuration while using only a relatively small number of keys.
- 4. DETECTING KEY ACTUATION IN A KEYBOARD** (US2010271310) by OLODORT ROBERT; TANG JOHN; TURCHIK RANDY. Description: A system and method for detecting key actuation in a **keyboard** assembly, which, in one embodiment, is used as a conductor to electrically communicate with an information appliance. The rows in the **keyboard** assembly are electrically isolated from one another, and each row contains keys bridging a two-wire bus. Each key has a switch that is closed during key actuation, a diode to polarize the key, and a resistor to provide a resistive load when the switch is closed and the diode is biased with the current flow. Alternatively, each key has a switch that is closed during key actuation, a timer with an output that goes high after a predetermined time period, and a resistor that provides an identifying load when the switch is closed and the output of the timer is high. Other features of the invention include a linear matrix coupled to a row of keys to allow the row to be scanned by sections and individual keys, and a flexible circuit that provides the electrical pathways for the linear matrix.

The interface also shows a sidebar with navigation options like "Searches", "My Session", and "My Searches". A right-hand panel displays details for a selected patent, including "Published As" (PCT WO2009100607, CN201145884), "Cited Patents", and "Document type" (U1 - Utility model).

Ex. Questel Orbit

Visualização apenas de figuras representativas para cada família de patentes

Orbit.com | Display | Add to | Export | Top | Citations | Compare | Save | Alert | Analyse

179 results for ((COLLAPSIBLE)/BI/SA AND (KEYBOARD)/BI/SA)

FAMPAT | Clear selection | 179 results are selected.

Google | Sort by relevance

#	Title	Original or current assignee	Publ. number	Pr. Date
<input checked="" type="checkbox"/>	COLLAPSIBLE PROJECTION ...			
<input checked="" type="checkbox"/>	Ventilation support for lapt...			
<input checked="" type="checkbox"/>	HANDHELD ELECTRONIC DEV...			
<input checked="" type="checkbox"/>	Handheld electronic device...			
<input checked="" type="checkbox"/>	Handheld electronic device...			
<input checked="" type="checkbox"/>	Handheld electronic device...			
<input checked="" type="checkbox"/>	MUSICAL INSTRUMENT SUP...			
<input checked="" type="checkbox"/>	COLLAPSIBLE PORTABLE DI...			
<input checked="" type="checkbox"/>	ADJUSTABLE PORTABLE CO...			
<input checked="" type="checkbox"/>	Innovated keyboard for per...			
<input checked="" type="checkbox"/>	Collapsible keyboard			
<input checked="" type="checkbox"/>	COLLAPSIBLE KEYBOARD			
<input checked="" type="checkbox"/>	Collapsible keyboard			
<input checked="" type="checkbox"/>	Handheld Electronic Device ...			
<input checked="" type="checkbox"/>	Handheld electronic device...			
<input checked="" type="checkbox"/>	Multifunctional portable co...			
<input checked="" type="checkbox"/>	Modularized electronic dev...			
<input checked="" type="checkbox"/>	An auxiliary device of learni...			
<input checked="" type="checkbox"/>	Tabulate computer			
<input checked="" type="checkbox"/>	Lectern			
<input checked="" type="checkbox"/>	Collapsible keyboard with ...			

FIG 2

FIG 3

FIG 4

Image unavailable, check for mosaic

Page 1 of 2 | Record 8 of 179 | Displaying records 1 - 100 of 179

Ex. Questel Orbit

Cobertura Geográfica
(Publicações por Países)



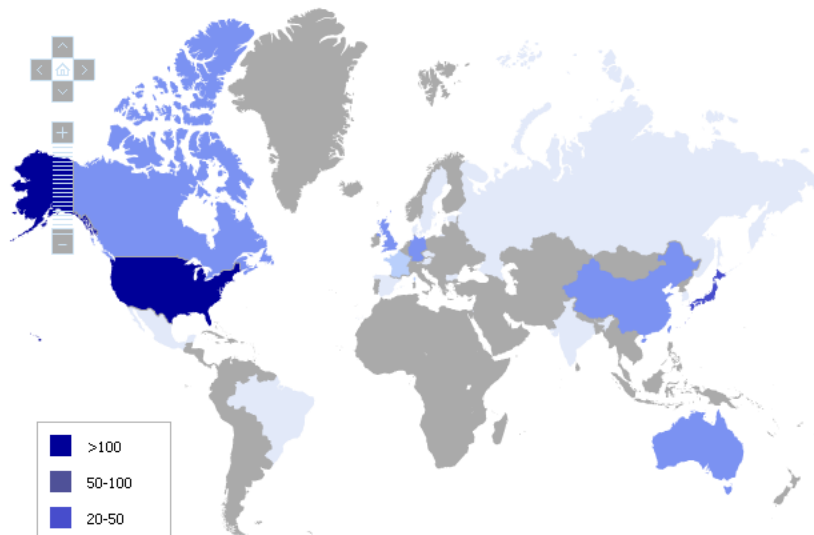
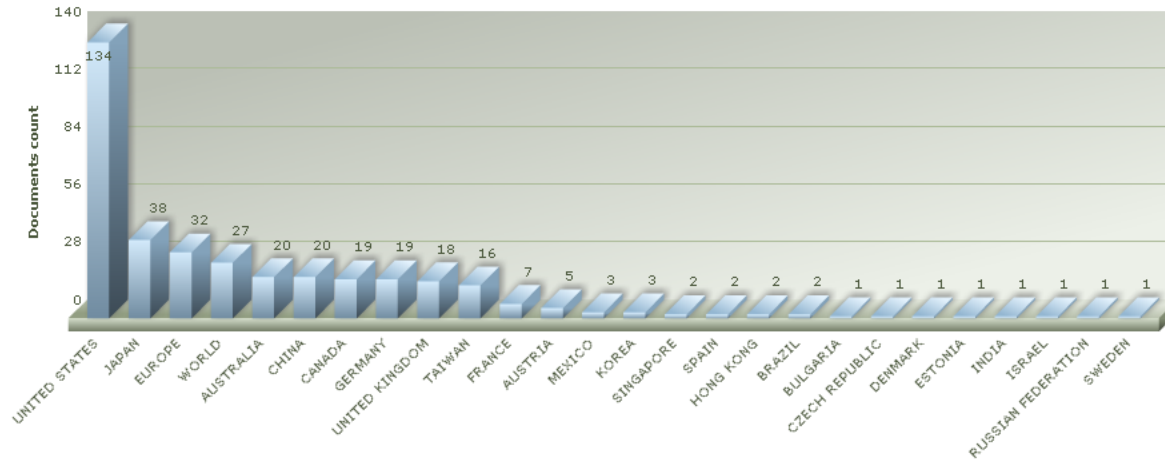
Documents Assignees Inventors Agent Technologies Data crossing Mapping (beta)

Graphic size: 1200px

INTELLEXIP

(COLLAPSIBLE)/BI/SA AND (KEYBOARD)/BI/SA

Geographical Distribution of patents based on publication country



Ex. Questel Orbit

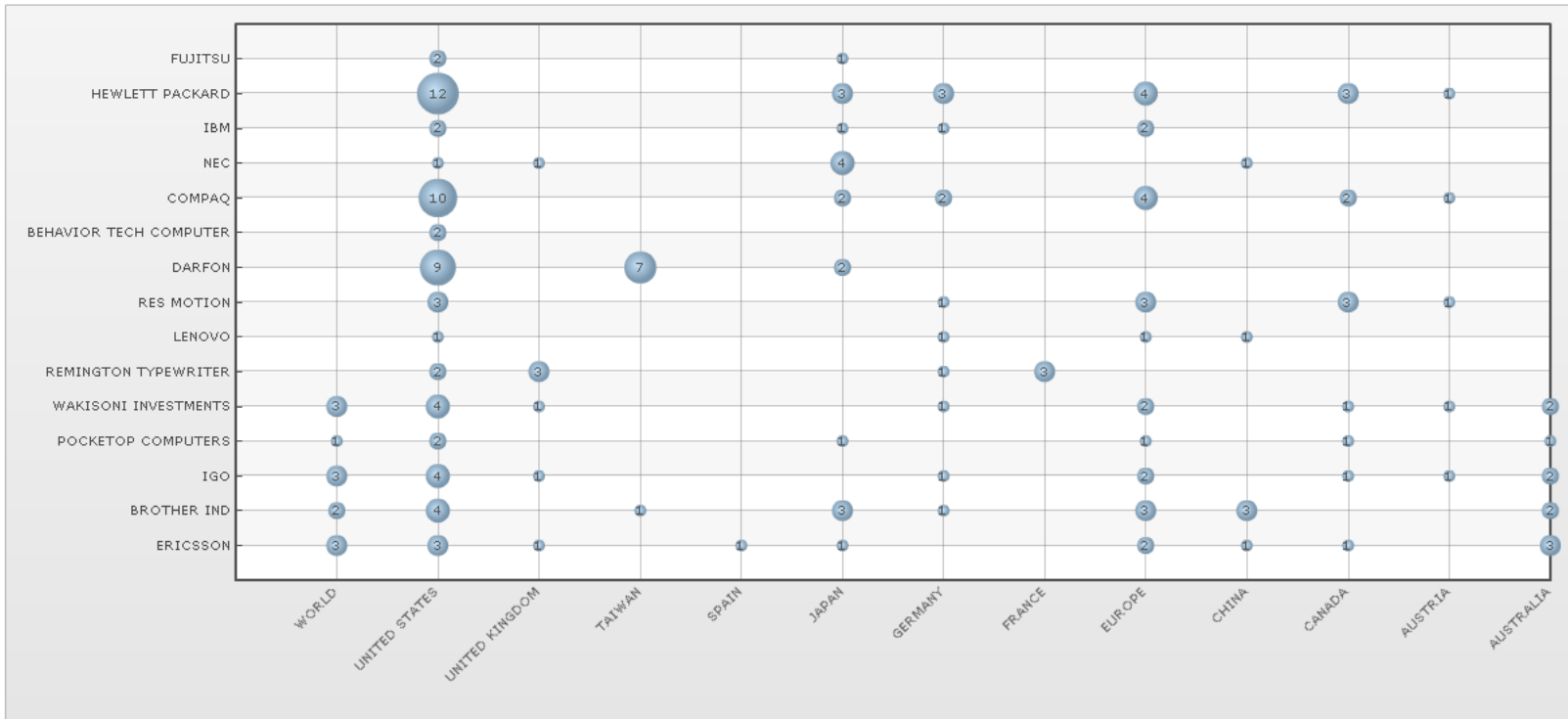
Cobertura Geográfica Principais Depositantes



Documents Assignees Inventors Agent Technologies Data crossing Mapping (beta) Graphic size: 1200px

((COLLAPSIBLE)/BI/SA AND (KEYBOARD)/BI/SA)

Bubble graph for Assignees/Patent country



Ex. Questel Orbit

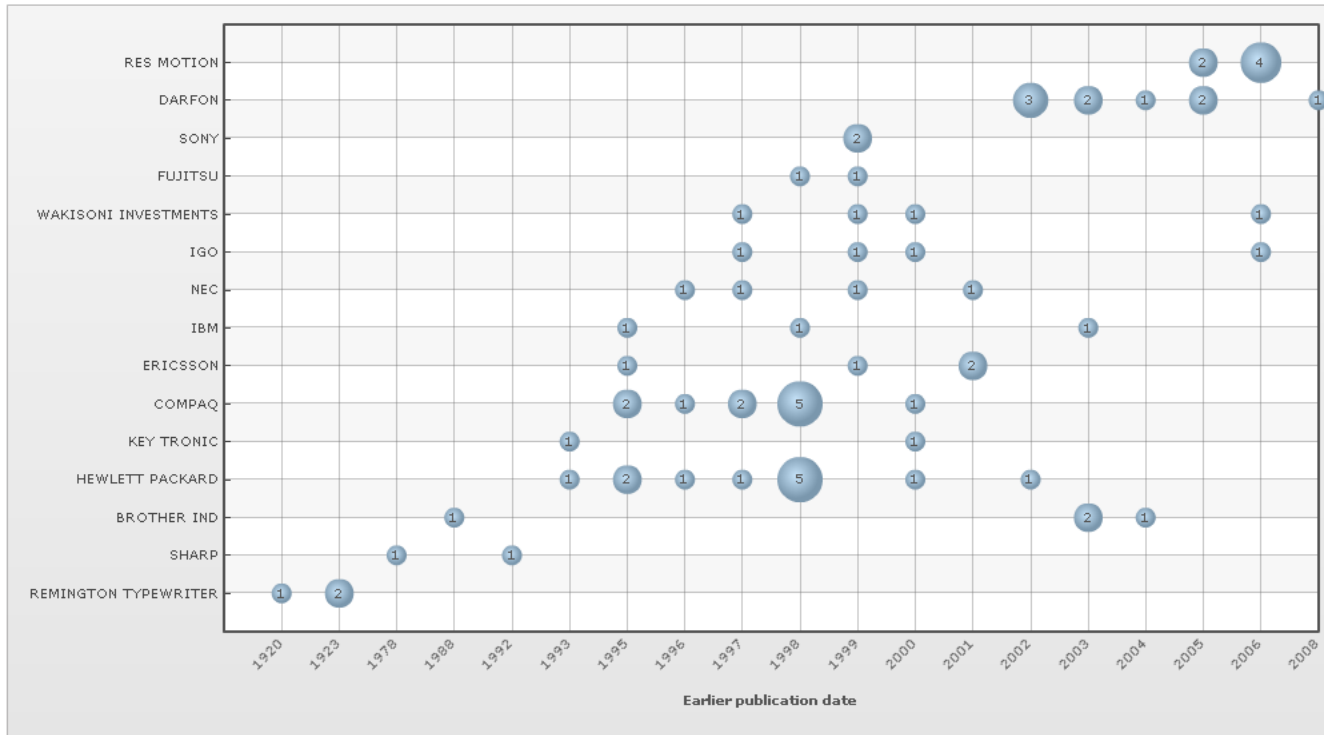
Evolução Temporal Principais Depositantes



Documents Assignees Inventors Agent Technologies Data crossing Mapping (beta) Graphic size: 1000px

((COLLAPSIBLE)/BI/SA AND (KEYBOARD)/BI/SA)

Evolution of top 15 assignees



Ex. Questel Orbit

Mapa de Citações: Titulares



Documents Assignees Inventors Agent Technologies Data crossing Mapping (beta) Graphic size: 1000px

((COLLAPSIBLE)/BI/SA AND (KEYBOARD)/BI/SA)

Citations map

Category: All OK

Zoom

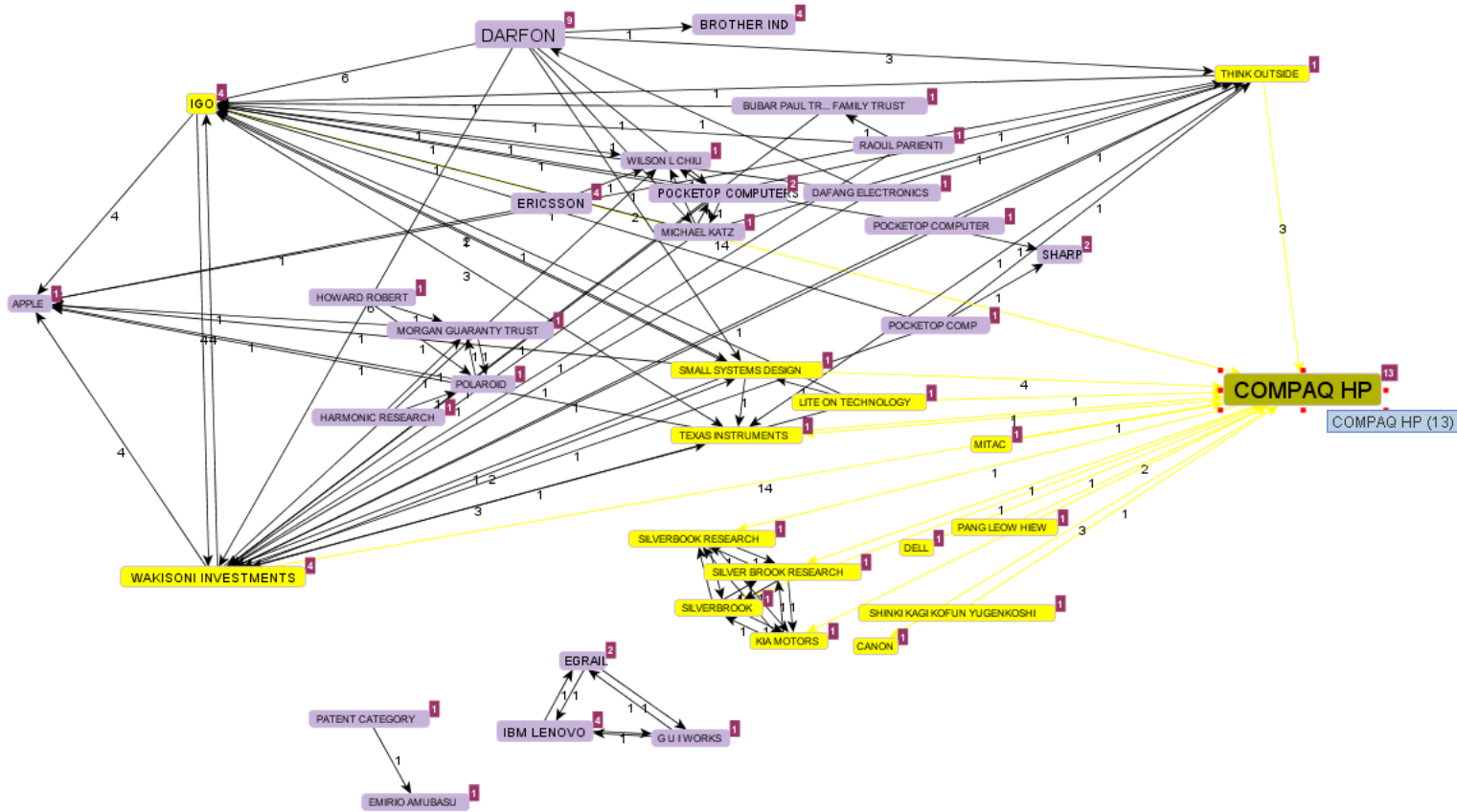


Cocurrences 1 Min Occurrences 1 Min

Duration 11 years End date 2006 Update Reset

Min citing 0 Min cited 0

- HARMONIC RESEA
- MITAC
- CANON
- SHINKI KAGI KOFU
- PANG LEOW HIEW
- HOWARD ROBERT
- RAOUL PARIENTI
- POLAROID
- SHARP
- POCKETOP COMP
- EMIRIO AMUBASU
- PATENT CATEGOR
- G U I WORKS
- IBM LENOVO
- EGRAIL
- DAFANG ELECTRO
- BUBAR PAUL TR...
- BROTHER IND
- DARFON
- DELL
- KIA MOTORS
- TEXAS INSTRUME
- SMALL SYSTEMS
- SILVERBOOK RES
- POCKETOP COMP
- WAKISONI INVEST
- POCKETOP COMP
- MORGAN GUARAN
- THINK OUTSIDE
- MICHAEL KATZ
- COMPAQ HP
- LITE ON TECHNOL
- APPLE
- IGO



Ex. Questel Orbit

Exportação para TXT, PDF, RTF, XLS, CSV, XML e Email. Exportação para VantagePoint, Intelixir, Bizint

The screenshot displays the Questel Orbit web interface. On the left, there is a navigation menu with sections like 'Searches', 'My Session', 'Past Sessions', 'My Searches', and 'My Lists'. The main area shows search results for 'Collapsible keyboard' with 179 results. A table lists results with columns for title, assignee, publication number, and date. An export menu is open, showing options like 'Export as TXT', 'Export as PDF', 'Export as RTF', 'Export as XLS', 'Export as CSV', 'Export as XML', 'Email (permalinks)', 'Bizint Export', 'VantagePoint Export', 'Export Intelixir', and 'My export profiles'. On the right, a technical drawing of a keyboard mechanism is shown with numbered callouts (30, 40, 42, 50, 54, 56, 60, 66, 70, 80, 90). Below the drawing, there is a list of references (AB, PA, PAH, PA0, RP) and their corresponding patent information.

#	Title	Original or current assignee	Publ. number	Pr. Date
1.	Computer s alternate di method the	MITAC TECHNOLOGY; SHINKI KAGI K...	US2004093449	2002-11-12
2.	Foldable ke	BROTHER INDUSTRIES	WO03104962	2002-06-04
3.	Collapsible	DARFON ELECTRONICS	US2003122690	2001-12-28
4.	Collapsible a computer		US6256017	1994-02-24
5.	Collapsible	DAFANG ELECTRONICS; DARFON EL...	US2005224320	2004-04-09
6.	Collapsible	DARFON ELECTRONICS	US2005258021	2004-05-21
7.	Collapsible	DARFON ELECTRONICS	US2003197628	2002-04-17
8.	Collapsible	IGO; WAKISONI INVESTMENTS	WO9843156	1997-03-21
9.	Collapsible	DARFON ELECTRONICS	US2002003530	2000-07-05
10.	Collapsible keyboard structure for a notebook computer	COMPAQ COMPUTER; COMPAQ INFO...	EP0691601	1994-06-30
11.	Foldable keyboard	BROTHER INDUSTRIES	WO03104961	2002-06-04
12.	Collapsible keyboard	BEHAVIOR TECHNOLOGY COMPUTER	US2003030623	2001-08-10
13.	Collapsible keyboard with supporting structure	DARFON ELECTRONICS	US2004175220	2003-03-07
14.	Collapsible keyboard	LITE ON TECHNOLOGY	US2003063939	2001-09-28
15.	Collapsible keyboard	DARFON ELECTRONICS	US2008173529	2004-04-09
16.	Collapsible keyboard pointing stick structure	COMPAQ INFORMATION TECHNOLOG...	US5786806	1996-03-29
17.	Compact notebook computer having a foldable and collapsible keyboard structure	COMPAQ COMPUTER; COMPAQ INFO...	EP0691603	1994-06-30
18.	Collapsible keyboard	APPLE	US5163765	1992-03-04
19.	Collapsible keyboard mechanism with integrated lcd display	COMPAQ INFORMATION TECHNOLOG...	US6137676	1998-05-22
20.	Collapsible keyboard	IGO; SMALL SYSTEMS DESIGN; WAKI...	WO9824963	1997-11-12
21.	Double spring collapsible keyboard structure for a notebook computer, responsive to opening and closing of the computer's lid via relatively shiftable key support structure and shift member	COMPAQ INFORMATION TECHNOLOG...	US5677826	1994-06-30
22.	Collapsible musical keyboard	BUBAR PAUL TRUSTEE OF THE DAVI...	US2004083877	2002-10-30
23.	Collapsible keyboard stand	ULTIMATE SUPPORT SYSTEMS	US4770380	1987-06-22

Collapsible keyboard

100

AB
(US20050224320)
A **collapsible keyboard** comprises a first key assembly, a second key assembly rotatably connected to the first key assembly and a third key assembly rotatably connected to the second key assembly. The first key assembly is located between the second and third key assemblies when the **collapsible keyboard** is in a collapsed mode, and the first key assembly, the second and third key assemblies are substantially located on the same level when the **collapsible keyboard** is in an operating mode.

III HSU CHIEN-SHIH
PA DAFANG ELECTRONICS
DARFON ELECTRONICS
PAH (US20050224320)
HSU CHIEN SHIH; FROM 20050317 TO 20050317
DARFON ELECTRONICS; FROM 20050317
(JP2005302016)
(A) DAFANG ELECTRONICS CO LTD
(TW-228739)
(B) DARFON ELECTRONICS CORP (TW)
(A) DARFON ELECTRONICS CORP
PA0 Darfon Electronics Corporation, Taoyuan [TW]
RP (US20050224320)
(A1) QUINTERO LAW OFFICE; 1617 BROADWAY, 3RD FLOOR, SANTA MONICA, CA, 90404[US]
(B2) Quintero Law Office

Page 1 of 8 Record 5 of 179

Ex. Questel Orbit

Exportação de múltiplos campos, incluindo imagens, reivindicações, famílias de patentes, etc.

The screenshot displays the Questel Orbit interface with search results for '179 results for ((COLLAPSIBLE)/BI/SA AND (K'. The results list includes:

- 1. Electromagnetic isolation chamber for manipulating devices therein (US20110031009)
- 2. Bedtime Computer Table (US20100300334)
- 3. HANDHELD ELECTRONIC DEVICE AND KEY HAVING MULTIPLE-FUNCTION KEYS (US20100271309)
- 4. DETECTING KEY ACTUATION IN A KEYBOARD (US20100271310)
- 5. (U3) Collapsible keyboard (JP3092668)

Two 'Export' dialog boxes are overlaid on the results:

- Template options:** Allows choosing data formatting. Options include 'Classical' and 'Kwic'. 'Patent number format' is set to 'Short'. Under 'Data', 'Complete' and 'Custom' are selected. 'With' options include 'Images', 'Full name for columns header', 'One member per line', and 'Representative member only'.
- Fields selection:** Allows selecting information to export. 'Select' is set to 'All'. Fields include 'FamPat Family Accession Number', 'FamPat Family Numbers and Dates', 'Publication Number Only', 'English Title - Native or Translation', 'Title - Other Languages', 'Priority Numbers and Dates', 'Oldest Priority Date', 'Inventor(s)', 'Assignee(s)', 'International Classification', 'European Classification', 'US Classification', 'Japanese Classification', 'English Abstract - Native or Official Trans.', 'English Abstract - Machine Translation', 'Abstract - Other Languages', 'Designated States', 'Key Info', 'Description', 'Claims', 'Patent and Non-Patent Literature Citations', 'Cited Patent Number Only', 'Legal Status', and 'Other'.

Navigation controls at the bottom show 'Page 1 of 2' and 'Record 1 of 179'.

Ex. Questel Orbit

Exportação de múltiplos campos, incluindo imagens, reivindicações, famílias de patentes, etc.


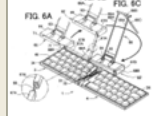
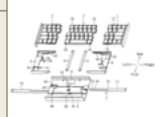
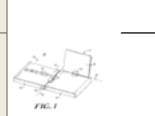
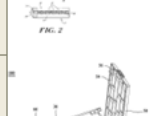
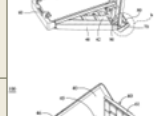
Microsoft Excel - Exemplo Relatório XLS

Arquivo Editar Exibir Inserir Formatar Ferramentas Dados Janela Ajuda Adobe PDF

75% Arial Unicode MS 10

Go to Office Live | Open | Save

D2 Computer system with collapsible keyboard and alternate display functions and processing method thereof

IMAGE	FAN	XPN	TI	PA	IC	AB	ECLM
	2009011710856	US7054973; US20040093449 DE10331550 JP2004164544 TW200407784	Computer system with collapsible keyboard and alternate display functions and processing method thereof	MITAC TECHNOLOGY SHINKI KAGI KOFUN YUGENKOSHI	G06F-001/16 G06F-001/18 G06F-003/02 G06F-003/023 G06F-009/44 G06F-013/00 G06F-013/20 G06F-013/24	(US20040093449) A computer system with collapsible keyboard and alternate display functions. The computer system includes a main body which stores at least one application. A monitor and collapsible keyboard are coupled to the main body, the keyboard disposable in an open operating position and a folded position. A signal generating device is coupled to both the collapsible keyboard and the main body to generate a first...	(US7054973) What is claimed is: 1. A computer system, comprising a main body for storing at least an application; a monitor coupled to the main body; a keyboard coupled to the main body, disposable in at least an open operating position and a folded position, wherein, when disposed in the folded position, the keyboard covers a first...
	2009011304584	WO2003104962 EP1510910 US20050105952 JP2004021416 JP2004013354 JP2004013343 JP2004013342 JP2004013340 JP2004013336 CN1856436 AU2003241978	FOLDABLE KEYBOARD	BROTHER INDUSTRIES	B41J-005/08 G06F-001/16 G06F-003/02 G06F-015/02	(WO2003104962) A control section (62) is provided independent of a keyboard (1), and the control section (62) and a first keyboard unit (3) are connected to each other by an adjustable arm (67). The control section (62) can be placed at substantially the center position of the keyboard (1) because of the adjustable characteristics of the adjustable arm (67). This enables PDA73 connected to a connection member (64) of the control section (62) to be...	(EP1510910) 1. A foldable keyboard in which a rotational connecting part is provided between a first keyboard unit in which a plurality of key switches to be operated for a left hand are arranged and a second keyboard unit in which a plurality of key switches to be operated for a right hand are arranged so that both units are rotated about the rotational connecting part in a direction to come apart from each other into a horizontally arranged state...
	20090110916458	US6950038; US20030122690 TW-534390U	Collapsible keyboard	DARFON ELECTRONICS	G06F-003/02 G06F-003/023 H03K-017/94 H03M-011/00	(US20030122690) A collapsible keyboard . The collapsible keyboard includes a keyboard chassis, a right track frame, a right key set and a main key set. The right track frame is disposed on the keyboard chassis and slides rightward and leftward. The right track frame has a first sloped sliding groove. The left portion of the first sloped sliding groove is higher than the right portion of the first sloped sliding groove. The right key set is connected to the right track frame during the right track frame move...	(US6950038) 1. A collapsible keyboard, comprising: a keyboard chassis; a right track frame slidably disposed on the keyboard chassis and sliding rightward and leftward, the right track frame having a first sloped sliding groove, wherein the left portion of the first sloped sliding groove is higher than the right portion of the first sloped sliding groove; a right key set movably connected to the right track frame...
	20090090073237	US6256017	Collapsible keyboard and display mechanism for a computer system		G06F-001/16 G06F-003/02 G09G-005/00	(US6256017) A collapsible keyboard and display mechanism for a computer system includes a collapsible keyboard having at least two independent keyboard sections and a first hinge device for enabling at least two of the keyboard sections to fold together in face to face relationship; and an independent display section disposed between the two keyboard sections in the collapsed condition.	(US6256017) What is claimed is: 1. A collapsible keyboard and display mechanism for a computer system comprising: a) A collapsible keyboard housing having at least two keyboard sections, said housing having a first hinge for enabling two of said keyboard sections to fold together in a face to face relationship, each of said keyboard sections having a...
	20090120271268	US7375295; US20050224320 JP2005302016 TW-228739; TW200534314	Collapsible keyboard	DAFANG ELECTRONICS DARFON ELECTRONICS	G06F-001/16 G06F-003/00 G06F-003/02 H01H-003/00 H01H-009/00 H01H-009/420 H01H-009/426 H01H-013/470	(US20050224320) A collapsible keyboard comprises a first key assembly, a second key assembly rotatably connected to the first key assembly and a third key assembly rotatably connected to the second key assembly. The first key assembly is located between the second and third key assemblies when the collapsible keyboard is in a collapsed mode, and the first key assembly, the second and third key assemblies are substantially located on the...	(US7375295) What is claimed is: 1. A collapsible keyboard, comprising: a first key assembly; a second key assembly rotatably connected to the first key assembly; a third key assembly rotatably connected to the second key assembly, wherein the first key assembly is located between the second and third key assemblies when the...
	20090120378246	US7153050; US20050258021 JP3112517U TW200539001	Collapsible keyboard	DARFON ELECTRONICS	B41J-011/00 B41J-011/56 B41J-029/06 G06F-003/02 H01H-009/00	(US20050258021) A collapsible keyboard comprises a connection part, a top cover pivoted to the connection part, a first key assembly connected to the connection part and movable between a first position and a second position, and a second key assembly pivoted to the first key assembly. The first key assembly is...	(US7153050) What is claimed is: 1. A collapsible keyboard, comprising: a connection part comprising a hook; a top cover pivoted to the connection part; a first key assembly connected to the connection part and movable between a first position and a second position; and...

Exemplo Relatório XLS

Ex. Questel Orbit

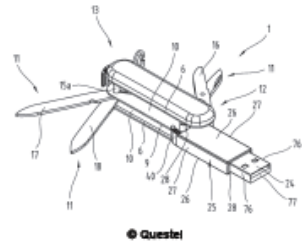
Pocket tool US20050081302

<p>Patent Assignee VICTORINORKS VICTORINOX</p> <p>Inventor ELSENER CARL</p> <p>International Patent Classification A61C-015/00;A61C-015/02;B25F;B25F-001/00;B25F-001/04;B26B;B26B-001/00;B26B-001/04;B26B-011/00;B26B-013/00;B26B-013/22;G06F;G06F-001/00;G06F-003/00;G06F-013/00;G06K-019/04;G06K-019/077;G11C;G11C-016/00</p> <p>US Patent Classification D07118000;D07170000</p>		<p>Publication Information US2005081302 A1 20050421 [US20050081302]</p> <p>Priority Details 2003AT-0001650 20031017 2004AT-0001579 20040921</p>																																																																																																	
<p>Patent family</p> <table border="1"> <tr> <td>DE102004048116</td> <td>B4</td> <td>20111208</td> <td>[DE102004048116]</td> </tr> <tr> <td>AT500428</td> <td>B1</td> <td>20110815</td> <td>[AT-500428]</td> </tr> <tr> <td>CN101890728</td> <td>A</td> <td>20101124</td> <td>[CN101890728]</td> </tr> <tr> <td>HK1073625</td> <td>A1</td> <td>20101119</td> <td>[HK1073625]</td> </tr> <tr> <td>FR2891179</td> <td>B1</td> <td>20100730</td> <td>[FR2891179]</td> </tr> <tr> <td>CH700252</td> <td>B1</td> <td>20100730</td> <td>[CH-700252]</td> </tr> <tr> <td>CN1628940</td> <td>B</td> <td>20100809</td> <td>[CN1628940B]</td> </tr> <tr> <td>FR2861007</td> <td>B1</td> <td>20090522</td> <td>[FR2861007]</td> </tr> <tr> <td>TW301790</td> <td>B</td> <td>20081011</td> <td>[TW-301790]</td> </tr> <tr> <td>GB2407056</td> <td>B</td> <td>20070912</td> <td>[GB2407056]</td> </tr> <tr> <td>AT500097</td> <td>B9</td> <td>20070815</td> <td>[AT-500097]</td> </tr> <tr> <td>AT500097</td> <td>B1</td> <td>20070715</td> <td>[AT-500097]</td> </tr> <tr> <td>FR2891179</td> <td>A1</td> <td>20070330</td> <td>[FR2891179]</td> </tr> <tr> <td>US7146567</td> <td>B2</td> <td>20051212</td> <td>[US7146567]</td> </tr> <tr> <td>AT500428</td> <td>A1</td> <td>20051215</td> <td>[AT-500428]</td> </tr> <tr> <td>AT500097</td> <td>A1</td> <td>20051015</td> <td>[AT-500097]</td> </tr> <tr> <td>TW200529993</td> <td>A</td> <td>20050916</td> <td>[TW200529993]</td> </tr> <tr> <td>CN1628940</td> <td>A</td> <td>20050622</td> <td>[CN1628940]</td> </tr> <tr> <td>DE102004048116</td> <td>A1</td> <td>20050512</td> <td>[DE102004048116]</td> </tr> <tr> <td>FR2861007</td> <td>A1</td> <td>20050422</td> <td>[FR2861007]</td> </tr> <tr> <td>US2005081302</td> <td>A1</td> <td>20050421</td> <td>[US2005081302]</td> </tr> <tr> <td>KR20050037399</td> <td>A</td> <td>20050421</td> <td>[KR20050037399]</td> </tr> <tr> <td>GB2407056</td> <td>A</td> <td>20050420</td> <td>[GB2407056]</td> </tr> <tr> <td>GB0422725</td> <td>D0</td> <td>20041117</td> <td>[GB200422725]</td> </tr> </table>				DE102004048116	B4	20111208	[DE102004048116]	AT500428	B1	20110815	[AT-500428]	CN101890728	A	20101124	[CN101890728]	HK1073625	A1	20101119	[HK1073625]	FR2891179	B1	20100730	[FR2891179]	CH700252	B1	20100730	[CH-700252]	CN1628940	B	20100809	[CN1628940B]	FR2861007	B1	20090522	[FR2861007]	TW301790	B	20081011	[TW-301790]	GB2407056	B	20070912	[GB2407056]	AT500097	B9	20070815	[AT-500097]	AT500097	B1	20070715	[AT-500097]	FR2891179	A1	20070330	[FR2891179]	US7146567	B2	20051212	[US7146567]	AT500428	A1	20051215	[AT-500428]	AT500097	A1	20051015	[AT-500097]	TW200529993	A	20050916	[TW200529993]	CN1628940	A	20050622	[CN1628940]	DE102004048116	A1	20050512	[DE102004048116]	FR2861007	A1	20050422	[FR2861007]	US2005081302	A1	20050421	[US2005081302]	KR20050037399	A	20050421	[KR20050037399]	GB2407056	A	20050420	[GB2407056]	GB0422725	D0	20041117	[GB200422725]
DE102004048116	B4	20111208	[DE102004048116]																																																																																																
AT500428	B1	20110815	[AT-500428]																																																																																																
CN101890728	A	20101124	[CN101890728]																																																																																																
HK1073625	A1	20101119	[HK1073625]																																																																																																
FR2891179	B1	20100730	[FR2891179]																																																																																																
CH700252	B1	20100730	[CH-700252]																																																																																																
CN1628940	B	20100809	[CN1628940B]																																																																																																
FR2861007	B1	20090522	[FR2861007]																																																																																																
TW301790	B	20081011	[TW-301790]																																																																																																
GB2407056	B	20070912	[GB2407056]																																																																																																
AT500097	B9	20070815	[AT-500097]																																																																																																
AT500097	B1	20070715	[AT-500097]																																																																																																
FR2891179	A1	20070330	[FR2891179]																																																																																																
US7146567	B2	20051212	[US7146567]																																																																																																
AT500428	A1	20051215	[AT-500428]																																																																																																
AT500097	A1	20051015	[AT-500097]																																																																																																
TW200529993	A	20050916	[TW200529993]																																																																																																
CN1628940	A	20050622	[CN1628940]																																																																																																
DE102004048116	A1	20050512	[DE102004048116]																																																																																																
FR2861007	A1	20050422	[FR2861007]																																																																																																
US2005081302	A1	20050421	[US2005081302]																																																																																																
KR20050037399	A	20050421	[KR20050037399]																																																																																																
GB2407056	A	20050420	[GB2407056]																																																																																																
GB0422725	D0	20041117	[GB200422725]																																																																																																



Arquivos exportáveis com famílias de patentes, incluindo hiperlinks para textos integrais, imagens e citações (mesmo para não assinantes)

Abstract:
(US20050081302)
The invention specifies a pocket tool, particularly a pocket knife (1) or plate-like tool card, comprising a housing (2) with at least one receiving area (10), and at least two functional components (11) movable from a storage position within the receiving area (10), into a working position outside of the receiving area (10). The first functional component (11) is designed as a tool, particularly a pair of scissors (16) or knife (1). The second functional component (11) has a support casing (25) and is equipped with a recordable and readable, nonvolatile memory, as well as with an interface (24). A releasable locking device and a longitudinal guide or pivot bearing are arranged between the support casing (25) of the second functional component (11) and the housing (2).



© Questel

Pesquisa de Patentes

Agregadores



- Dialog (www.dialog.com) *
- Questel (www.questel.com)
- STN (www.stn-international.de) *
- Lexis Nexis (www.lexisnexis.com)
- Etc...

Pesquisa de Patentes

Meta- Agregadores



- Landon IP, Inc (www.landon-ip.com)
- Cardinal IP, LLC (www.cardinal-ip.com)
- Nerac, Inc (www.nerac.com)
- CPA Global (www.cpaglobal.com)
- Etc...



Uso Estratégico de Propriedade Intelectual e Informações Tecnológicas

Foco no Setor Farmacêutico

- Agenda

- Propriedade Intelectual no contexto farmacêutico, com destaque a patentes
- Uso estratégico de patentes e informações patentárias
- Ferramentas e técnicas de busca e análise de informações tecnológicas
- Fontes, sistemas de busca e análise de informações com foco na área farmacêutica
- **Exemplo de mapeamento de segmento tecnológico**

Uso Estratégico de Patentes & Informações Tecnológicas em Projetos de P&D

FIOCRUZ - Rio de Janeiro, RJ
29 de abril de 2013

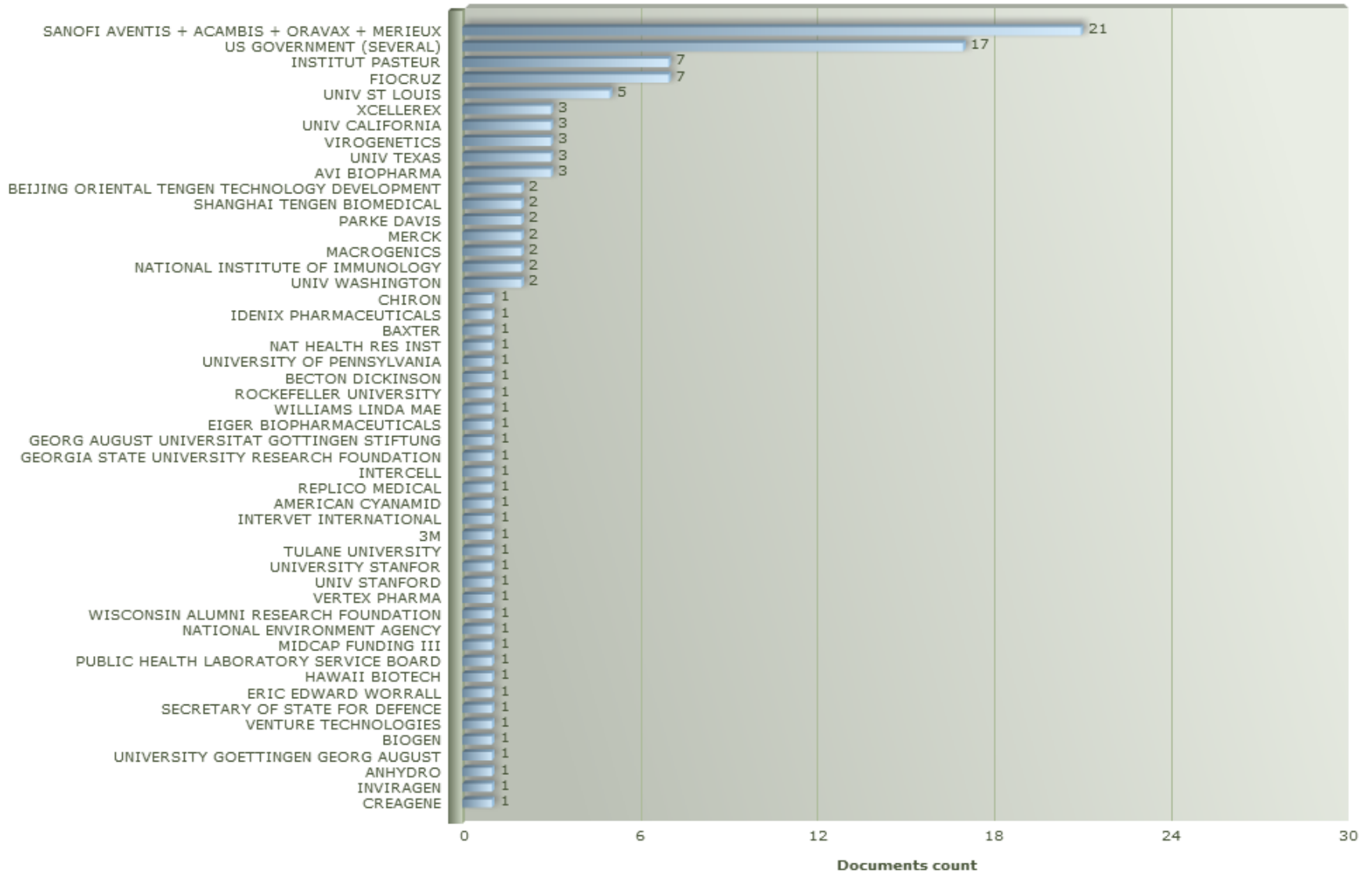
Exemplo

Vacinas contra Febre Amarela e outros Flavivírus.

- Em relação a patentes de terceiros...
- Em relação a notificações de estudos clínicos...
- Em relação a publicações técnicas...
- Em relação a informações sobre esforços de P&D de terceiros...
- Em relação a notícias...
- Em relação a opiniões de experts...

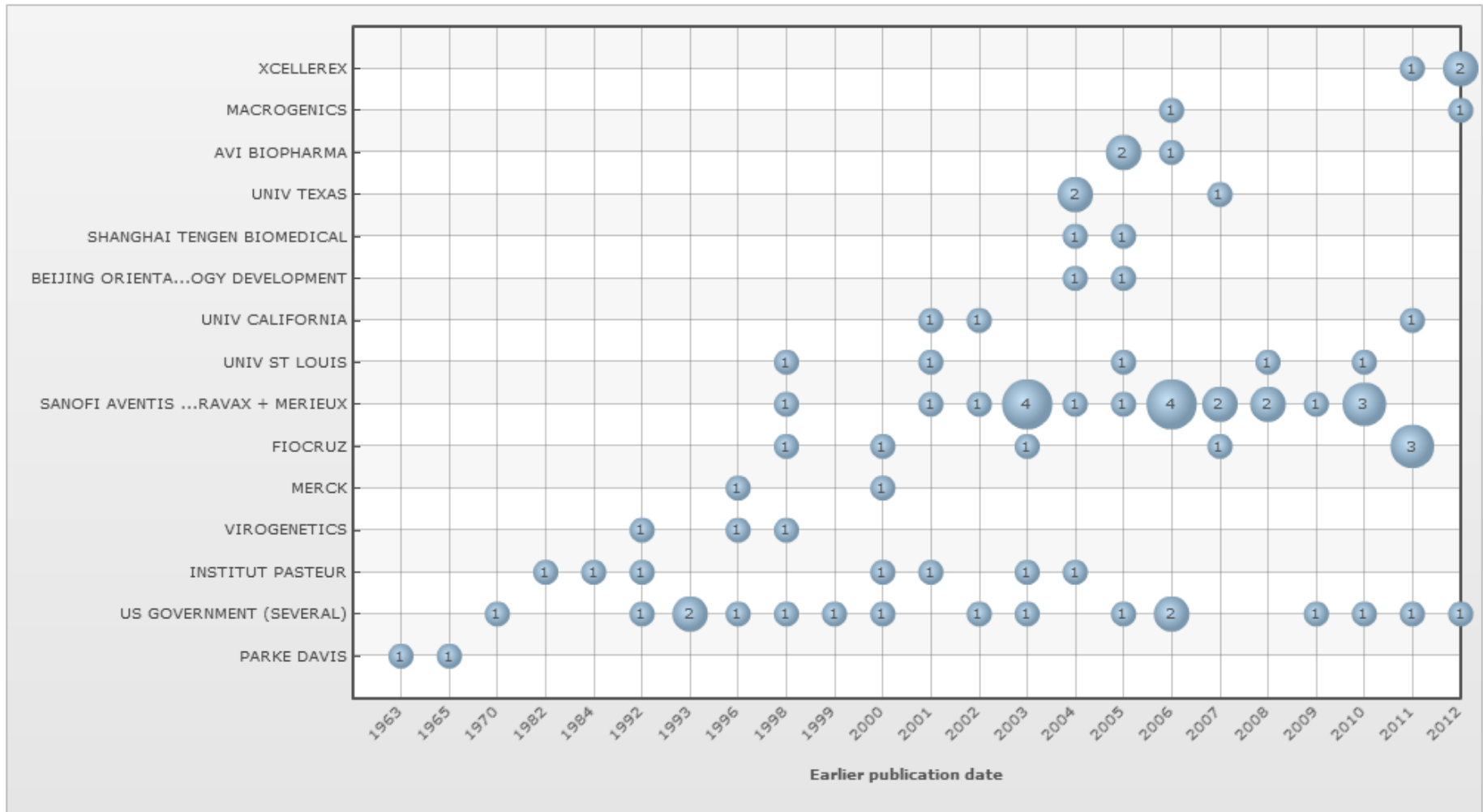
Em relação a patentes de terceiros...

Febre Amarela maiores depositantes

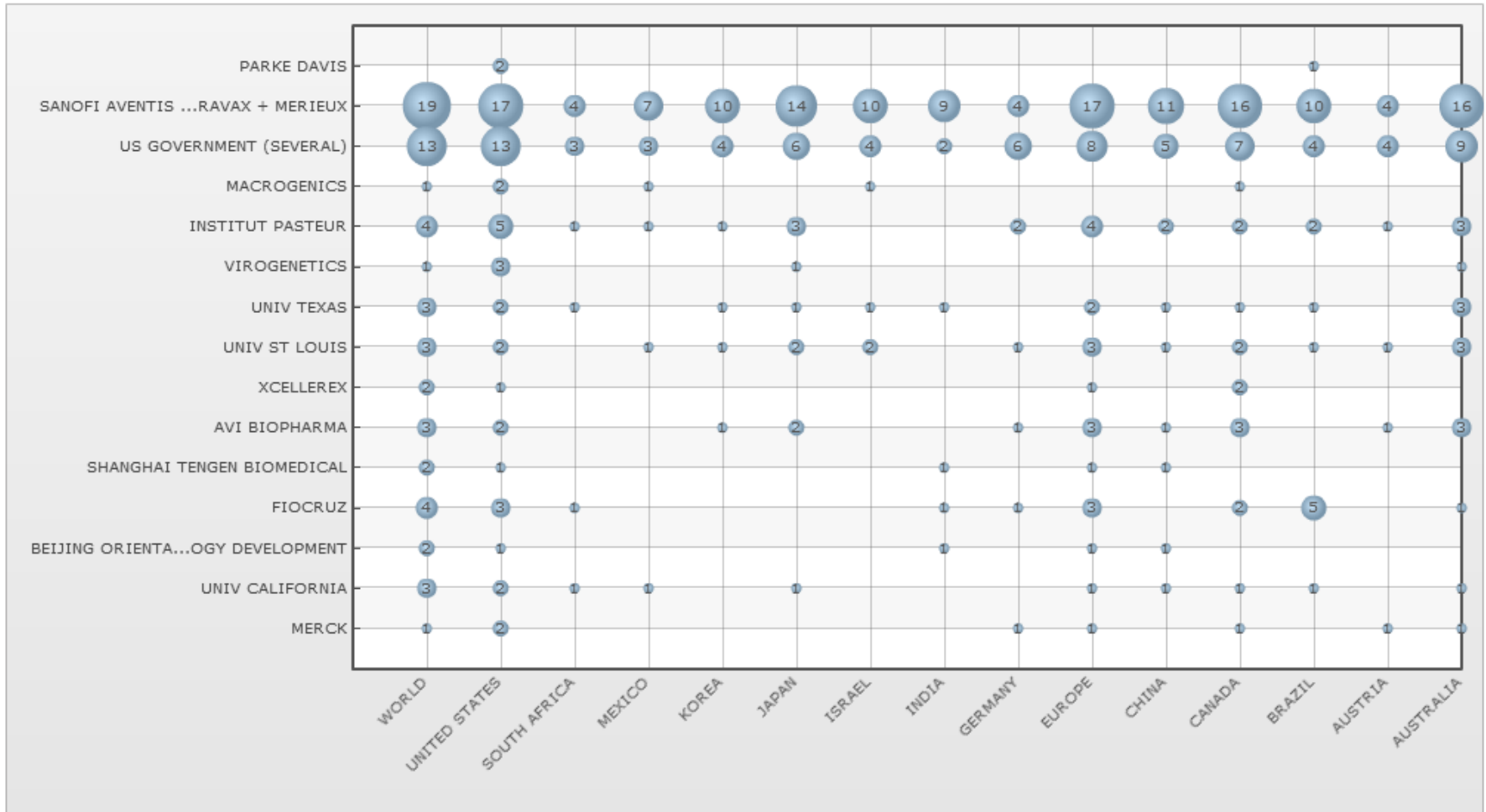


Febre Amarela maiores depositantes

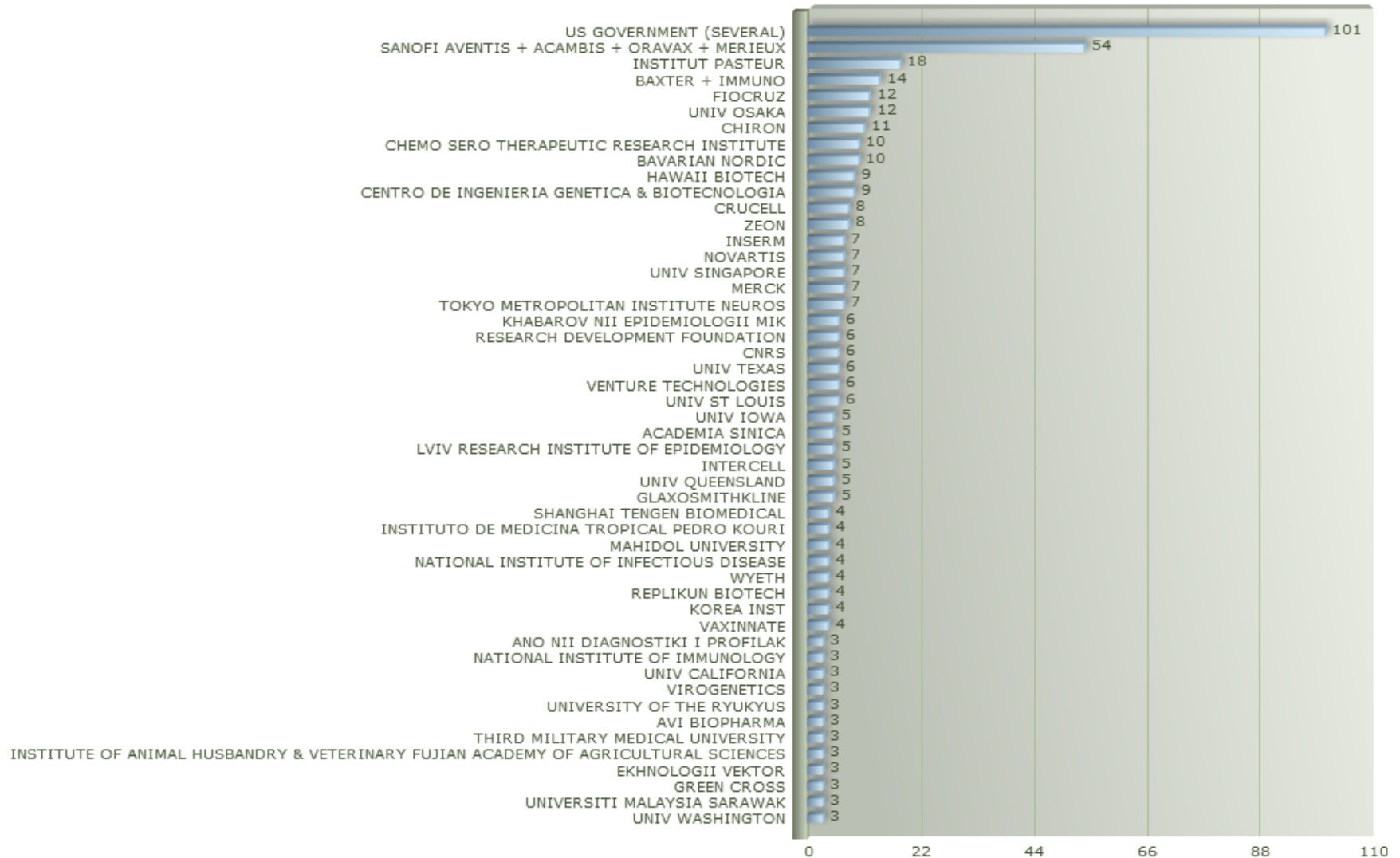
evolução temporal



Febre Amarela maiores depositantes cobertura geográfica

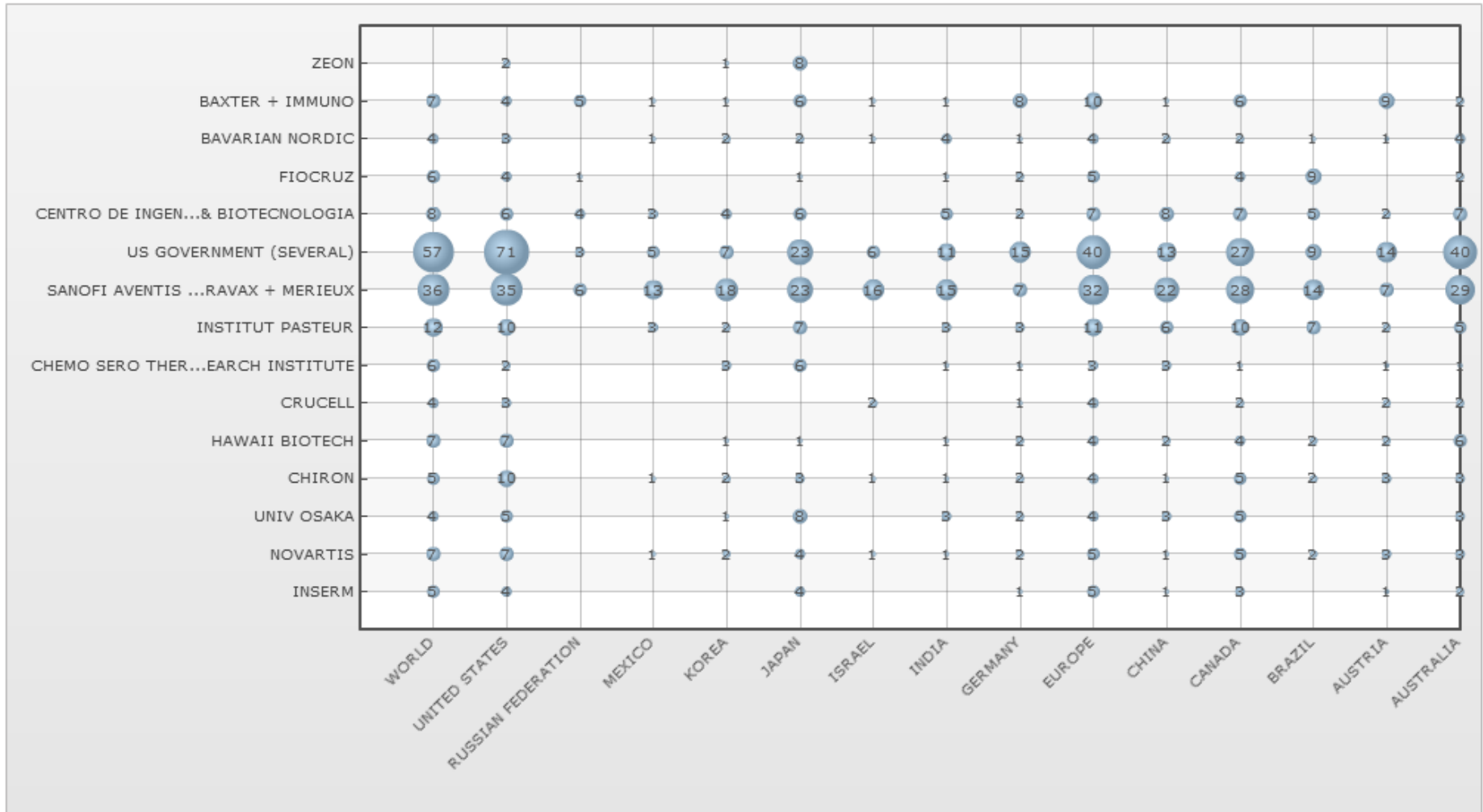


Flavivirus maiores depositantes



Flavivirus maiores depositantes

cobertura geográfica



Em relação a notificações de estudos clínicos...

Arquivo | Página Inicial | Inserir | Layout da Página | Fórmulas | Dados | Revisão | Exibição

Calibri | 11 | A A

Fonte | Alinhamento | Número | Estilo | Células | Edição

Formatação Condicional | Formatar como Tabela | Estilos de Célula

Inserir | Excluir | Formatar

Classificar e Filtrar | Localizar e Selecionar | Share This File | WebEx

Rank	Phases	Start Year	Sponsor/Collaborators	Title	Recr
2	1	2011	Emory University Sri Edupuganti, MD MPH University of California, Berkeley	Turnover of Antigen Specific Lymphocytes After Immunization With the Yellow Fever Vaccine	Recr
3	3 Phase 2	2011	Sanofi-Aventis Sanofi-Aventis	Immune Response to Different Schedules of a Tetravalent Dengue Vaccine Given With or Without Yellow Fever Vaccine	Acti
4	4 Phase 3	2011	Sanofi-Aventis Sanofi-Aventis	Study of Yellow Fever Vaccine Administered With Tetravalent Dengue Vaccine in Healthy Toddlers	Acti
5	8 Phase 3	2011	French National Institute for Health and Medical Research-French National Agency for Research on AIDS and Viral Hepatitis (Inserm-ANRS) French National Agency for Research on AIDS and Viral Hepatitis	The Yellow Fever Vaccine Immunity in HIV Infected Patients : Development of New Assays for Virological and Immunological Monitoring in HIV Infected Patient.	Com
8	16 Phase 3	2011	Novartis Novartis Novartis Vaccines	A Phase 3b, Randomized, Open-Label Study to Evaluate the Safety and Immunogenicity of Select Travel Vaccines When Administered Concomitantly With MenACWY in Adults	Acti
9	6	2010	Emory University Emory University	Immune Responses to Yellow Fever Vaccine	Enrc
10	11 Phase 1	2010	Xcellerex, Inc. Xcellerex, Inc.	Trial of Yellow Fever Inactivated Vaccine	Acti
11	5	2008	Emory University Emory University	Human Immune Responses to The Yellow Fever Virus Vaccine	Recr
16	18	2007	Rockefeller University Rockefeller University Emory University	Characterization of T Cell Responses Following Yellow Fever Virus Vaccination in Healthy Adults	Com
17	2 Phase 1	2006	Emory University Emory University Sanofi Pasteur MSD Centers for Disease Control and Prevention	Yellow Fever Virus Vaccine and Immune Globulin Study	Com
20	9 Phase 2	2004	Sanofi-Aventis Sanofi-Aventis	Study of Live Attenuated Japanese Encephalitis Vaccine (ChimeriVaxã,,C-JE) and Yellow Fever Vaccine (STAMARILÂ®)	Com

Arquivo | Página Inicial | Inserir | Layout da Página | Fórmulas | Dados | Revisão | Exibição

Normal | Layout da Página | Modos de Exibição Personalizados | Tela Inteira

Modos de Exibição de Pasta de Trabalho | Mostrar | Barra de Fórmulas | Linhas de Grade | Títulos

Zoom 100% | Zoom na Seleção

Nova Janela | Organizar Tudo | Congelar Painéis

Salvar Espaço de Trabalho | Alternar Janelas

Macros

Rank	Start	Phase	Sponsor/Collaborators	Title	Recru	Study	Cond	Interv	Enroll	Start	Comp	Prims	URL	
2	7	2012	Phase 2	Sanofi-Aventis Sanofi-Aventis U.S. Army Medical Research and Materiel Command U.S. Army Medical Research and Materiel Command GlaxoSmithKline Walter Reed Army Institute of Research (WRAIR)	Study of a Tetravalent Dengue Vaccine in Healthy Adult Subjects Aged 18 to 45 Years in India	Active, n	No Resu	Dengue	Biologic	189	March 20	Decemb	Decemb	http://ClinicalTrials.gov/show/NCT01550289
3	47	2012	Phase 1	Sanofi-Aventis Sanofi-Aventis	A Two-dose Primary Vaccination Study of a Tetravalent Dengue Virus Purified Inactivated Vaccine vs. Placebo in Healthy Adults	Not yet r	No Resu	Dengue f	Biologic	100	Septemb	Decemb	Decemb	http://ClinicalTrials.gov/show/NCT01666652
4	48	2012	Phase 1	Merck Merck	Study of a Dengue Vaccine (V180) in Healthy Adults (V180-001 AM1)	Recruiti	No Resu	Dengue	Biologic	120	July 2012	Decemb	Decemb	http://ClinicalTrials.gov/show/NCT01477580
6	3	2011	Phase 2	Sanofi-Aventis Sanofi-Aventis	Immune Response to Different Schedules of a Tetravalent Dengue Vaccine Given With or Without Yellow Fever Vaccine	Active, n	No Resu	Dengue	Biologic	330	Decemb	June 201	June 201	http://ClinicalTrials.gov/show/NCT01488890
7	9	2011	Phase 3	Sanofi-Aventis Sanofi-Aventis	Study of a Novel Tetravalent Dengue Vaccine in Healthy Children Aged 2 to 14 Years in Asia	Recruiti	No Resu	Dengue	Biologic	10278	June 201	July 2014	July 2014	http://ClinicalTrials.gov/show/NCT01373281
8	10	2011	Phase 3	Sanofi-Aventis Sanofi-Aventis	Study of a Novel Tetravalent Dengue Vaccine in Healthy Children and Adolescents Aged 9 to 16 Years in Latin America	Active, n	No Resu	Dengue f	Biologic	20875	June 201	August 2	August 2	http://ClinicalTrials.gov/show/NCT01374516
9	11	2011	Phase 3	Sanofi-Aventis Sanofi-Aventis	Study of Yellow Fever Vaccine Administered With Tetravalent Dengue Vaccine in Healthy Toddlers	Active, n	No Resu	Dengue	Biologic	792	Septemb	January 2	January 2	http://ClinicalTrials.gov/show/NCT014136396
10	12	2011	Phase 3	Sanofi-Aventis Sanofi-Aventis	Study of a Booster Injection of Pentaxim®, a Vaccine Administered With Dengue Vaccine in Healthy Toddlers	Recruiti	No Resu	Dengue	Biologic	732	July 2011	April 20	April 20	http://ClinicalTrials.gov/show/NCT01411241
11	18	2011	Phase 1	U.S. Army Medical Research and Materiel Command U.S. Army Medical Research and Materiel Command Vical Walter Reed Army Institute of Research (WRAIR) Naval Medical Research Center	Evaluation of the Safety and the Ability of a DNA Vaccine to Protect Against Dengue Disease	Active, n	No Resu	Dengue f	Biologic	40	Decemb	Decemb	Decemb	http://ClinicalTrials.gov/show/NCT01502358
12	46	2011	Phase 1	U.S. Army Medical Research and Materiel Command U.S. Army Medical Research and Materiel Command	Safety Study of a Vaccine (DENV-1 PIV) to Prevent Dengue Disease	Active, n	No Resu	Dengue f	Biologic	20	Decemb	Septemb	Septemb	http://ClinicalTrials.gov/show/NCT01502735
14	13	2010	Phase 2	Sanofi-Aventis Sanofi-Aventis	A Study of Dengue Vaccine in Healthy Toddlers Aged 12 to 15 Months in the	Active, n	No Resu	Dengue f	Biologic	210	January 2	Septemb	Septemb	http://ClinicalTrials.gov/show/NCT01064141
15	14	2010	Phase 3	Sanofi-Aventis Sanofi-Aventis	Study of a Tetravalent Dengue Vaccine in Healthy Adults in Australia	Active, n	No Resu	Dengue f	Biologic	715	October	October	Novemb	http://ClinicalTrials.gov/show/NCT01134263
16	16	2010	Phase 2	Sanofi-Aventis Sanofi-Aventis	Study of CYD Dengue Vaccine in Healthy Children and Adolescents in South America	Active, n	No Resu	Dengue	Biologic	150	August 2	June 201	Decemb	http://ClinicalTrials.gov/show/NCT01187433
17	17	2010	Phase 3	Sanofi-Aventis Sanofi-Aventis	Study of a Tetravalent Dengue Vaccine in Healthy Children Aged 2 to 11 Years in	Active, n	No Resu	Dengue f	Biologic	250	Decemb	January 2	January 2	http://ClinicalTrials.gov/show/NCT01254422
18	26	2010	Phase 1	National Institute of Allergy and Infectious Diseases (NIAID) National Institute of Allergy and Infectious Diseases (NIAID) Johns Hopkins Bloomberg School of Public Health	Evaluation of the Safety and Immune Response of Five Admixtures of a Tetravalent Dengue Virus Vaccine	Active, n	No Resu	Dengue	Biologic	140	July 2010			http://ClinicalTrials.gov/show/NCT01072786
19	32	2010	Phase 1	National Institute of Allergy and Infectious Diseases (NIAID) National Institute of Allergy and Infectious Diseases (NIAID)	Tetravalent Chimeric Dengue Vaccine Trial	Comple	No Resu	Dengue	Drug; Pl	72	May 201	April 20	April 20	http://ClinicalTrials.gov/show/NCT01110551
20	37	2010	Phase 1	National Institute of Allergy and Infectious Diseases (NIAID) National Institute of Allergy and Infectious Diseases (NIAID)	Evaluation of the Safety and Immune Response to an Investigational Dengue Type 1 Vaccine	Active, n	No Resu	Dengue	Biologic	18	April 2010			http://ClinicalTrials.gov/show/NCT01084291
21	38	2010	Phase 1	National Institute of Allergy and Infectious Diseases (NIAID) National Institute of Allergy and Infectious Diseases (NIAID)	Safety and Immune Response to an Investigational Dengue Type 2 Vaccine	Comple	No Resu	Dengue	Biologic	18	February	June 201	June 201	http://ClinicalTrials.gov/show/NCT01073306
22	45	2010	Phase 1	Inviragen Inc. Inviragen Inc.	Safety and Immunogenicity Study to Assess DENVax, a Live Attenuated Tetravalent Vaccine for Prevention of Dengue Fever	Active, n	No Resu	Dengue f	Biologic	112	October	Septemb	June 201	http://ClinicalTrials.gov/show/NCT01224639

Arquivo | Página Inicial | Inserir | Layout da Página | Fórmulas | Dados | Revisão | Exibição

Normal | Visualização da Quebra de Página | Régua | Barra de Fórmulas | Nova Janela | Organizar Tudo | Congelar Painéis | Salvar Espaço de Trabalho | Alternar Janelas | Macros

Layout da Página | Modos de Exibição Personalizados | Tela Inteira | Linhas de Grade | Títulos | Zoom 100% | Zoom na Seleção | Janela

Modos de Exibição de Pasta de Trabalho | Mostrar

	A	B	D	E	F
1	Rank	Start Year	Phases	Sponsor/Collaborators	Title
6	2	2008	Phase 1	Hawaii Biotech, Inc. Hawaii Biotech, Inc.	Safety Study of HBV-002 West Nile Vaccine in Healthy Adults
7	3	2008	Phase 2	Sanofi-Aventis Sanofi-Aventis	Safety and Immunogenicity Study of ChimeriVax West Nile Vaccine in Healthy Adults
8	5	2008	Phase 1	National Institute of Allergy and Infectious Diseases (NIAID) National Institute of Allergy and Infectious Diseases (NIAID) Johns Hopkins Bloomberg School of Public Health	Safety of and Immune Response to a West Nile Virus Vaccine (WN/DEN4delta30) in Healthy A
12	6	2006	Phase 1	National Institutes of Health Clinical Center (CC) National Institute of Allergy and Infectious Diseases (NIAID)	Phase I Study of West Nile Virus Vaccine
15	1	2005	Phase 2	Sanofi-Aventis Sanofi-Aventis	Safety and Immunogenicity of ChimeriVax-WN02 West Nile Vaccine in Healthy Adults
16	4	2005	Phase 1	National Institute of Allergy and Infectious Diseases (NIAID) National Institute of Allergy and Infectious Diseases (NIAID) Johns Hopkins Bloomberg School of Public Health	Safety of and Immune Response to a West Nile Virus Vaccine (WN/DEN4-3'delta30) in Health
17	7	2005	Phase 1	National Institutes of Health Clinical Center (CC) National Institute of Allergy and Infectious Diseases (NIAID)	Vaccine to Prevent West Nile Virus Disease
20					
21					
22					
23					
24					

Arquivo | Página Inicial | Inserir | Layout da Página | Fórmulas | Dados | Revisão | Exibição

Normal | Layout da Página | Tela Inteira | Modos de Exibição Personalizados | Visualização da Quebra de Página

Mostrar: Régua Barra de Fórmulas Linhas de Grade Títulos

Zoom: 100% | Zoom na Seleção

Janela: Nova Janela, Organizar Tudo, Congelar Painéis

Salvar Espaço de Trabalho, Alternar Janelas, Macros

Rank	Start	Phase	Sponsor/Collaborators	Title	Recru	Study	Condi	Interv	
1			Indian Institute of Science Indian Institute of Science National Institute of Mental Health and Neurosciences University of Liverpool Program for Appropriate Technology in Health Wellcome Trust	A Prospective, Open Label Study of Human T Cell Responses to Live Attenuated Japanese Encephalitis Vaccine SA14-14-2	Recruiting	No Result	Japanese Encephalitis	Biological	
2	1	2012	Phase 4	Novartis Novartis Vaccines	Safety and Immunogenicity of 2 Different Vaccination Schedules of Rabies and Japanese Encephalitis Vaccines in Healthy Adults	Not yet recruiting	No Result	Rabies Japanese Encephalitis	Biological
3	18	2012	Phase 3	Intercell AG Intercell AG	Immune Response in IXIARO Batch JEV09L37 Recipients Before and After Revaccination	Not yet recruiting	No Result	Japanese Encephalitis	Biological
4	22	2012	Phase 4	Program for Appropriate Technology in Health Program for Appropriate Technology in Health	Lot-to-lot Consistency Trial of JE Live Attenuated SA 14-14-2 Vaccine	Not yet recruiting	No Result	Japanese Encephalitis	Biological
5	45	2012	Phase 4	Intercell AG Intercell AG	Safety Surveillance After Immunization With IXIARO	Recruiting	No Result	Japanese Encephalitis	Biological
7	24	2011	Phase 3	Novartis Novartis Vaccines	A Phase 3b, Randomized, Open-Label Study to Evaluate the Safety and Immunogenicity of Select Travel Vaccines	Active, not recruiting	No Result	Meningococcal	Biological
8	29	2011	Phase 3	Sanofi-Aventis Sanofi-Aventis	Study of a Live Attenuated Japanese Encephalitis Chimeric Virus Vaccine (IMJJEV) Compared to CD. JEVAX	Active, not recruiting	No Result	Japanese Encephalitis	Biological
9	38	2011	Phase 3	Mahidol University Pornthep Chanthavanich Liaoning Cheng Da Biotechnology Co., Ltd. China Bionet-Asia Co., Ltd. Thailand	Immunogenicity and Safety of Inactivated Vero Cell Derived Japanese Encephalitis Vaccine in Thai Children	Active, not recruiting	No Result	Encephalitis	Biological
11	7	2010	Phase 3	Intercell AG Intercell AG	Open-label, Randomized Study in a Pediatric Population in a JEV(Japanese Encephalitis Vaccine)-Endemic Country	Active, not recruiting	No Result	Japanese Encephalitis	Biological
14	17	2010	Phase 3	Boryung Pharmaceutical Co., Ltd Boryung Pharmaceutical Co., Ltd Seoul National University Hospital Gachon University Gil Medical Center Inha University Hospital Inje University Korea Cancer Center Hospital Samsung Medical Center The Catholic University of Korea Ewha Womans University	Clinical Trial to Assess the Immunogenicity and Safety of the Vero Cell-derived JE Vaccine in Korea	Recruiting	No Result	Japanese Encephalitis	Biological
15	31	2010	Phase 3	Intercell AG Intercell AG	Long Term Immunity and Safety Following Vaccination With the JEV IC51 (IXIARO, JESPECT) in Pediatric Population	Recruiting	No Result	Japanese Encephalitis	Procedural
16	33	2010	Phase 3	Sanofi-Aventis Sanofi-Aventis	A Study of Japanese Encephalitis Chimeric Virus Vaccine Compared With SA14-14-2 Vaccine in Infants and Toddlers	Complete	No Result	Encephalitis	Biological
17	35	2010	Phase 3	Sanofi-Aventis Sanofi-Aventis	Study of Japanese Encephalitis Chimeric Virus Vaccine Given With Measles-Mumps-Rubella Vaccine in Taiwanese Children	Active, not recruiting	No Result	Japanese Encephalitis	Biological
18	39	2010	Phase 3	Sanofi-Aventis Sanofi-Aventis	Study of Japanese Encephalitis Chimeric Virus Vaccine (JE-CV) in Children Previously Immunized With JE-CV	Active, not recruiting	No Result	Japanese Encephalitis	Biological
19	40	2010	Phase 3	Sanofi-Aventis Sanofi-Aventis	Study of Japanese Encephalitis Chimeric Virus Vaccine (JE-CV) in Children Previously Immunized With JE-CV	Active, not recruiting	No Result	Japanese Encephalitis	Biological
20	47	2010	Phase 4	Intercell AG Intercell AG	This is a Study to Assess the Safety and Immunogenicity of Ixiaro (IC51) in an Elderly Population	Complete	No Result	Japanese Encephalitis	Biological
21	48	2010	Phase 3	Mennonite Christian Hospital Mennonite Christian Hospital	Seroepidemiology of Japanese Encephalitis Virus Infection in Hualien, Taiwan	Enrolling	No Result	Japanese Encephalitis	Biological
23	43	2009	Phase 3	Sanofi-Aventis Sanofi-Aventis	Long-term Follow-up of Immunogenicity of a Single Dose of Japanese Encephalitis Chimeric Virus Vaccine in Toddler Population	Enrolling	No Result	Encephalitis Japanese Encephalitis	Biological
24	2	2008	Phase 3	Sanofi-Aventis Sanofi-Aventis	Study of Chimeric Japanese Encephalitis Vaccine in Toddlers in Thailand and the Philippines	Complete	No Result	Japanese Encephalitis	Biological

Em relação a publicações técnicas...

- Easy Search
- Advanced Search**
- CAS Number Search
- Patent Lookup

Review Saved Items

- + Help
- Session Cost
- Price List
- Preferences
- Search History
- + Cust. Support
- Comments
- Log Off**

Results for [Search Question:](#)

yellow fever

Save these search terms for future use

- 4617 answers in [BIOSIS](#)
- 499 answers in [BIOTECHNO](#)
- 2669 answers in [CABA](#)
- 2574 answers in [CAplus](#)
- 6926 answers in [EMBASE](#)
- 1031 answers in [ESBIOBASE](#)
- 2 answers in [KOSMET](#)
- 4611 answers in [MEDLINE](#)
- 1252 answers in [PASCAL](#)
- 3560 answers in [SCISEARCH](#)
- 27741 total hits

[\[Hide Database Info.\]](#)

Too many answers?

[Refine Your Search](#)

<input type="button" value="Clear"/>	Titles from BIOSIS in Most Recent Order Best Match Order
<input type="checkbox"/> 1	Proteomic Biomarkers for Ageing the Mosquito Aedes aegypti to Determine Risk of Pathogen Transmission. [\$3.45]
<input type="checkbox"/> 2	Electrophysiology of the isolated and perfused midgut of adult female yellow fever mosquitoes (Aedes aegypti). [\$3.45]
<input type="checkbox"/> 3	Inhibition of strong midgut alkalinization in larval yellow fever mosquitoes (Aedes aegypti) with HEPES buffer. [\$3.45]
<input type="checkbox"/> 4	The effect of targeted silencing of ferritin in the yellow fever mosquito, Aedes aegypti. [\$3.45]
<input type="checkbox"/> 5	Identification and characterization of a novel ferritin subunit from Aedes aegypti. [\$3.45]
<input type="checkbox"/> 6	The effect of bacterial challenge on ferritin regulation in Aedes aegypti. [\$3.45]
<input type="checkbox"/> 7	PROBLEMS OF MEDICAL PARASITOLOGY. [\$3.45]
<input type="checkbox"/> 8	SCANNING ELECTRON MICROSCOPY OF EGGS OF SABETHES CYANEUS. [\$3.45]
<input type="checkbox"/> 9	Active assessment of adverse events following yellow fever vaccination of persons aged 60 years and more. [\$3.45]
<input type="checkbox"/> 10	The other half of the insect SLC4 family: a Cl/HCO3 anion exchanger from mosquito renal tubules. [\$3.45]
<input type="checkbox"/> 11	Evolution of resistance to satyriization through reproductive character displacement in populations of invasive dengue vectors. [\$3.45]

Results for [Search Question:](#)**yellow fever AND Title: yellow fever and vaccin?****Save** these search terms for future use428 answers in [BIOSIS](#)73 answers in [BIOTECHNO](#)286 answers in [CABA](#)183 answers in [CAplus](#)709 answers in [EMBASE](#)169 answers in [ESBIOBASE](#)0 answers in [KOSMET](#)538 answers in [MEDLINE](#)205 answers in [PASCAL](#)383 answers in [SCISEARCH](#)

2974 total hits

[\[Hide Database Info.\]](#)

Too many answers?

[Refine Your Search](#)[Show Duplicates](#)

Clear	Titles from BIOSIS in Most Recent Order Best Match Order
<input type="checkbox"/> 1	Active assessment of adverse events following yellow fever vaccination of persons aged 60 years and more. [\$3.45]
<input type="checkbox"/> 2	The Synergistic Effect of Combined Immunization with a DNA Vaccine and Chimeric Yellow Fever/Dengue Virus Leads to Strong Protection against Dengue. [\$3.45]
<input type="checkbox"/> 3	Safety and Immunogenicity of Yellow Fever Vaccine in Patients Receiving Systemic Corticosteroid Therapy: An Observational Cohort Study. [\$3.45]
<input type="checkbox"/> 4	Identification of three H-2K(d) restricted CTL epitopes of NS4A and NS4B protein from Yellow fever 17D vaccine. [\$3.45]
<input type="checkbox"/> 5	T-Cell Memory Responses Elicited by Yellow Fever Vaccine are Targeted to Overlapping Epitopes Containing Multiple HLA-I and -II Binding Motifs. [\$3.45]
<input type="checkbox"/> 6	A Randomized, Double-Blind, Controlled Trial of the 17D Yellow Fever Virus Vaccine Given in Combination with Immune Globulin or Placebo: Comparative Viremia and Immunogenicity. [\$3.45]
<input type="checkbox"/> 7	17DD and 17D-213/77 Yellow Fever Substrains Trigger a Balanced Cytokine Profile in Primary Vaccinated Children. [\$3.45]
<input type="checkbox"/> 8	Detection of Anti-Yellow Fever Virus Immunoglobulin M Antibodies at 3-4 Years Following Yellow Fever Vaccination. [\$3.45]
	Quality control for yellow fever vaccines used in the Brazilian National Immunization Program.

Easy Search
[Advanced Search](#)
 CAS Number Search
 Patent Lookup

Review Saved Items

+ Help
 Session Cost
 Price List
 Preferences
 Search History
 + Cust. Support
 Comments
Log Off

Results for [Search Question:](#)**yellow fever AND Title: yellow fever and vaccin?****Save** these search terms for future use428 answers in [BIOSIS](#)73 answers in [BIOTECHNO](#)286 answers in [CABA](#)183 answers in [CAplus](#)709 answers in [EMBASE](#)169 answers in [ESBIOBASE](#)538 answers in [MEDLINE](#)205 answers in [PASCAL](#)383 answers in [SCISEARCH](#)

2974 total hits

[\[Hide Database Info.\]](#)

Too many answers?

[Refine Your Search](#)

<input type="button" value="Clear"/>	Titles from BIOSIS in Most Recent Order Best Match Order
<input type="checkbox"/> 1	Active assessment of adverse events following yellow fever vaccination of persons aged 60 years and more. [\$3.45] This answer is also in EMBASE, SCISEARCH
<input type="checkbox"/> 2	The Synergistic Effect of Combined Immunization with a DNA Vaccine and Chimeric Yellow Fever/Dengue Virus Leads to Strong Protection against Dengue. [\$3.45]
<input type="checkbox"/> 3	Safety and Immunogenicity of Yellow Fever Vaccine in Patients Receiving Systemic Corticosteroid Therapy: An Observational Cohort Study. [\$3.45]
<input type="checkbox"/> 4	Identification of three H-2K(d) restricted CTL epitopes of NS4A and NS4B protein from Yellow fever 17D vaccine. [\$3.45] This answer is also in CABA, CAPLUS, EMBASE, ESBIOBASE, MEDLINE, PASCAL, SCISEARCH
<input type="checkbox"/> 5	T-Cell Memory Responses Elicited by Yellow Fever Vaccine are Targeted to Overlapping Epitopes Containing Multiple HLA-I and -II Binding Motifs. [\$3.45]
<input type="checkbox"/> 6	A Randomized, Double-Blind, Controlled Trial of the 17D Yellow Fever Virus Vaccine Given in Combination with Immune Globulin or Placebo: Comparative Viremia and Immunogenicity. [\$3.45] This answer is also in CABA, EMBASE, MEDLINE, SCISEARCH
<input type="checkbox"/> 7	17DD and 17D-213/77 Yellow Fever Substrains Trigger a Balanced Cytokine Profile in Primary Vaccinated Children. [\$3.45]
<input type="checkbox"/> 8	Detection of Anti-Yellow Fever Virus Immunoglobulin M Antibodies at 3-4 Years Following Yellow Fever Vaccination. [\$3.45]

Em relação a informações sobre esforços de
P&D de terceiros...

Exemplo: Flavivirus (ADIS R&D Insight)

	A	B	C	E
1	PRODUCT NAME	COMPANY	HIGHEST DEVPT PHASE	DATABASE
12	BERNA-YF; FLAVIMUN(R); YELLOW FEVER VACCINE - CRUCELL; attenuated yellow fever (YF) vaccine of the 17D strain	CRUCELL; BERNA BIOTECH	03. PREREGISTRATION	ADISINSIGHT
13	JAPANESE ENCEPHALITIS VACCINE - BORYUNG PHARMACEUTICAL; KD 287; KD-287; VERO CELL-DERIVED INACTIVATED JAPANESE ENCEPHALITIS VACCINE KD-287	BORYUNG PHARMACEUTICAL; BORYUNG	04. PHASE III	ADISINSIGHT
14	CHIMERIVAX-DENGUE; ATTENUATED; CHIMERIVAX(TM) TETRAVALENT DENGUE VACCINE; CHIMERIVAX(TM)-DEN1-4; CYD DENGUE VACCINE; DENGUE SEROTYPE 1; DENGUE VACCINE TETRAVALENT - SANOFI; LIVE; TETRAVALENT DENGUE VACCINE; 2; 3; 4 VIRUS VACCINE	SANOPI PASTEUR; ACAMBIS; INTERNATIONAL VACCINE INSTITUTE	04. PHASE III	ADISINSIGHT
15	JAPANESE ENCEPHALITIS VACCINE - BHARAT BIOTECH; JENVAC	BHARAT BIOTECH	05. PHASE II	ADISINSIGHT
16	CHIKUNGUNYA VIRUS VACCINE - INVIRAGEN; CHIKV - INVIRAGEN	INVIRAGEN; SINGVAX; DUKE-NUS GRADUATE MEDICAL SCHOOL SINGAPORE	05. PHASE II	ADISINSIGHT
17	DENVAX(TM); NEEDLE-FREE DENGUE VACCINE; TETRAVALENT HYBRID DENGUE VIRUS VACCINE - INVIRAGEN/CDC/NIAID. DENVax is a tetravalent (four-component) combination vaccine containing the original attenuated DEN-2 PDK-53 vaccine and each of the chimeric vaccines (DEN-2/1, DEN-2/3 and DEN-2/4).	INVIRAGEN; CENTERS FOR DISEASE CONTROL AND PREVENTION; NATIONAL INSTITUTE OF ALLERGY AND INFECTIOUS DISEASES; NATIONAL INSTITUTES OF HEALTH (USA); DUKE-NUS GRADUATE MEDICAL SCHOOL SINGAPORE; PHARMAJET; UNIVERSITY OF	05. PHASE II	ADISINSIGHT
18	DENGUE VACCINE - GLAXOSMITHKLINE	WALTER REED ARMY INSTITUTE OF RESEARCH; GLAXOSMITHKLINE; OSWALDO CRUZ FOUNDATION	05. PHASE II	ADISINSIGHT
19	HILTONOL(R); P.I.C.L.C.; POLY ICLC; POLY-ICLC; POLYINOSINIC POLYCYTIDYLIC ACID; POLYRIBOINOSINIC-POLYRIBOCYTIDYLIC ACID-POLYLYSINE CARBOXYMETHYLCELLULOSE; POLYRIBOINOSINIC-POLYRIBOCYTIDYLIC ACID	ONCOVIR; NATIONAL CANCER INSTITUTE (USA); UNIVERSITY OF PITTSBURGH	05. PHASE II	ADISINSIGHT

Em relação a notícias...

Results for [Search Question](#):**vaccin? AND Publication Year: 2012-current AND yellow fever** these search terms for future use3 answers in [CBNB](#)0 answers in [CIN](#)

3 total hits

[\[Hide Database Info.\]](#)Too many
answers?

<input type="button" value="Clear"/>	Titles from CBNB in Most Recent Order Best Match Order
<input type="checkbox"/> 1	Successful vaccine developments at Themis Bioscience, Pasteur Institute Technology proves its effective potential. [\$7.60]
<input type="checkbox"/> 2	iBio selects proprietary recombinant C1 inhibitor for clinical development. [\$7.60]
<input type="checkbox"/> 3	Sanofi Pasteur's Val-de-Reuil site increase yellow fever vaccines capacity. Sanofi Pasteur Val-de-Reuil monte en puissance contre la fièvre jaune. [\$7.60]

[Page 1]

Display Selection Display Format Display Style

Easy Search

Advanced Search

CAS Number Search

Patent Lookup

Review Saved Items

+ Help

Session Cost

Price List

Preferences

Search History

+ Cust. Support

Comments

Log Off

Results for [Search Question:](#)

vaccin? AND Publication Year: 2012-current AND west nile

Save these search terms for future use

7 answers in [CBNB](#)

0 answers in [CIN](#)

7 total hits

[\[Hide Database Info.\]](#)

Too many answers?

[Refine Your Search](#)

<input type="button" value="Clear"/>	Titles from CBNB in Most Recent Order Best Match Order
<input type="checkbox"/> 1	Hawaii Biotech Gains Rights to West Nile Vaccine Technology From Merck. [\$7.60]
<input type="checkbox"/> 2	Hawaii Biotech Inc gains rights to West Nile vaccine technology from Merck & Co Inc. [\$7.60]
<input type="checkbox"/> 3	News and press releases: Committee for Medicinal Products for Veterinary Use (CVMP) Meeting of 9-11 Apr 2013: CVMP opinions on veterinary medicinal products. [\$7.60]
<input type="checkbox"/> 4	Pending EC decision: Equilis West Nile, inactivated chimeric Flavivirus strain YF-WN. Opinion date: 11-Apr-2013. [\$7.60]
<input type="checkbox"/> 5	Successful vaccine developments at Themis Bioscience, Pasteur Institute Technology proves its effective potential. [\$7.60]
<input type="checkbox"/> 6	News and press releases: Committee for Medicinal Products for Veterinary Use (CVMP) meeting of 8-10 Jan 2013: Pharmacovigilance. [\$7.60]
<input type="checkbox"/> 7	News and press releases: Committee for Medicinal Products for Veterinary Use (CVMP) meeting of 10-12 Jul 2012: Pharmacovigilance. [\$7.60]

[Page 1]

Display Selection Display Format Display Style

- Easy Search
- Advanced Search**
- CAS Number Search
- Patent Lookup

Review Saved Items

- + Help
- Session Cost
- Price List
- Preferences
- Search History
- + Cust. Support
- Comments
- Log Off**

Results for [Search Question:](#)

vaccin? AND Publication Year: 2012-current AND japanese encephalitis

 these search terms for future use
39 answers in [CBNB](#)0 answers in [CIN](#)

39 total hits

[\[Hide Database Info.\]](#)

Too many
 answers?

<input type="button" value="Clear"/>	Titles from CBNB in Most Recent Order Best Match Order
<input type="checkbox"/> 1	Successful vaccine developments at Themis Bioscience, Pasteur Institute Technology proves its effective potential. [\$7.60]
<input type="checkbox"/> 2	Intercell AG announces 4Q and preliminary full year 2012 financial results and business update: Business highlights: Solid IXIARO/JESPECT sales growth performance. [\$7.60]
<input type="checkbox"/> 3	Indian Immunologicals to develop Chikungunya and Japanese encephalitis vaccines. [\$7.60]
<input type="checkbox"/> 4	Intercell announces pediatric approval of its Japanese Encephalitis vaccine in Europe. [\$7.60]
<input type="checkbox"/> 5	Vabiotech licenses Inviragen technology for Japanese encephalitis vaccine production. [\$7.60]
<input type="checkbox"/> 6	Bharat Bio to launch Japanese encephalitis vaccine by Apr 2013. [\$7.60]
<input type="checkbox"/> 7	Proposed Merger of Equals between Vivalis and Intercell - Creation of a European biotech leader in vaccines and antibodies. [\$7.60]
<input type="checkbox"/> 8	Intercell receives CHMP positive opinion for the pediatric indication of its Japanese Encephalitis vaccine in Europe. [\$7.60]
<input type="checkbox"/> 9	JEEV Infusing life into humanity. [\$7.60]
<input type="checkbox"/> 10	Vivalis to buy Intercell AG in European biotech merger for \$174 M. [\$7.60]
<input type="checkbox"/> 11	Vaccine producer Intercell and Vivalis merge. Impfstoffhersteller Intercell und Vivalis fusionieren. [\$7.60]
<input type="checkbox"/> 12	Sanofi Pasteur launches next generation Japanese encephalitis vaccine in Thailand. [\$7.60]
<input type="checkbox"/> 13	Sanofi Pasteur launches Japanese encephalitis vaccine in Australia. [\$7.60]
<input type="checkbox"/> 14	Sanofi Pasteur launches Imojev first single-dose vaccine against Japanese encephalitis in

Results for [Search Question:](#)

vaccin? AND Publication Year: 2012-current AND dengue

Save these search terms for future use

23 answers in [CBNB](#)

1 answers in [CIN](#)

24 total hits

[\[Hide Database Info.\]](#)

Too many answers?

[Refine Your Search](#)

Clear	Titles from CBNB in Most Recent Order Best Match Order
<input type="checkbox"/> 1	Participation in Global Health Innovative Technology Fund (GHIT Fund). [\$7.60]
<input type="checkbox"/> 2	A*STAR: Australia and Singapore join forces to tackle emerging infectious diseases. [\$7.60]
<input type="checkbox"/> 3	VaxInnate awarded US grant to develop recombinant vaccine for dengue. [\$7.60]
<input type="checkbox"/> 4	Successful vaccine developments at Themis Bioscience, Pasteur Institute Technology proves its effective potential. [\$7.60]
<input type="checkbox"/> 5	Nagasaki University and Astellas launch collaborative research for screening new anti-dengue virus drugs for neglected tropical diseases. [\$7.60]
<input type="checkbox"/> 6	European vaccines market poised for growth. [\$7.60]
<input type="checkbox"/> 7	Dengue fever vaccine proves effective. [\$7.60] This answer is also in CIN
<input type="checkbox"/> 8	Sanofi Pasteur obtains mixed results for dengue vaccine trial. Vaccins: resultats mitigés de Sanofi Pasteur contre la dengue. [\$7.60]
<input type="checkbox"/> 9	Dengue weapons. [\$7.60]
<input type="checkbox"/> 10	Sanofi Pasteur announces publication in The Lancet of world's first efficacy results for its dengue vaccine candidate. [\$7.60]
<input type="checkbox"/> 11	Sanofi (France) dengue vaccine less effective than hoped. [\$7.60]
<input type="checkbox"/> 12	Sanofi (France)'s world first dengue vaccine beats 3 virus strains. [\$7.60]

- Easy Search
- Advanced Search**
- CAS Number Search
- Patent Lookup

Review Saved Items

- + Help
- Session Cost
- Price List
- Preferences
- Search History
- + Cust. Support
- Comments
- Log Off**

Easy Search

Advanced Search

CAS Number Search

Patent Lookup

Review Saved Items

+ Help

Session Cost

Price List

Preferences

Search History

+ Cust. Support

Comments

Log Off

<input type="checkbox"/> 8	Sanofi Pasteur obtains mixed results for dengue vaccine trial. Vaccins : resultats mitiges de Sanofi Pasteur contre la dengue . [\$7.60]
<input type="checkbox"/> 9	Dengue weapons. [\$7.60]
<input type="checkbox"/> 10	Sanofi Pasteur announces publication in The Lancet of world's first efficacy results for its dengue vaccine candidate. [\$7.60]
<input type="checkbox"/> 11	Sanofi (France) dengue vaccine less effective than hoped. [\$7.60]
<input type="checkbox"/> 12	Sanofi (France)'s world first dengue vaccine beats 3 virus strains. [\$7.60]
<input type="checkbox"/> 13	Sanofi (France)'s world first dengue vaccine beats 3 virus strains. [\$7.60]
<input type="checkbox"/> 14	Panacea Biotec: Hard hit by WHO. [\$7.60]
<input type="checkbox"/> 15	BioDiem licenses hepatitis vaccine tech from UC [\$7.60]
<input type="checkbox"/> 16	BioDiem sets sights on dengue fever vaccine. [\$7.60]
<input type="checkbox"/> 17	BioDiem closes dengue fever deal. [\$7.60]
<input type="checkbox"/> 18	BioDiem, ANU sign Dengue fever vaccine technology agreement. [\$7.60]
<input type="checkbox"/> 19	BioDiem Ltd signs full agreement with Australian National University for dengue fever vaccine technology. [\$7.60]
<input type="checkbox"/> 20	Australian National University to Grant BioDiem Ltd exclusive licence for novel technology to target infectious diseases. [\$7.60]
<input type="checkbox"/> 21	BioNet shifts strategy to new multipurpose vaccines. [\$7.60]
<input type="checkbox"/> 22	MNCs circle, descend on Indian vaccine market: Introduction of immunisation programme and aggressive product rollout by domestic firms are prompting MNCs to strengthen presence. [\$7.60]
<input type="checkbox"/> 23	US Navy advances dengue DNA vaccine using Vical Inc's vaxfectin adjuvant. [\$7.60]
	Titles from CIN in Most Recent Order
<input type="checkbox"/> 24	Dengue fever vaccine proves effective [\$6.10] This answer is also in CBNB

[Page 1]

Display Selection Display Format Display Style

Display Answers



US Navy Advances Dengue DNA Vaccine Using Vical Inc Vaxfectin Adjuvant



suzuki@marcelinosuzuki.com ▾

Web Images Maps Shopping More ▾ Search tools



About 1,480 results (0.15 seconds)

Ad related to **US Navy Advances Dengue DNA Vaccine Using ...** ⓘ

Dengue Antigen - Microbix.com

www.microbix.com/dengue

High Quality Native Dengue Antigens Fast Shipping! Expert Virologists.

US Navy Advances Dengue DNA Vaccine Using Vical's ... - Vical, I...

www.vical.com/.../US-Navy-Advances-Dengue-DNA-Vaccine-Using-Vic... ▾

Mar 5, 2012 – U.S. Navy Advances Dengue DNA Vaccine Using Vical's ... dengue DNA vaccine formulated with the company's Vaxfectin® adjuvant. The trial ...

US Navy Advances Dengue DNA Vaccine Using Vical ... - Reuters

www.reuters.com/finance/stocks/VICL.O/key-developments/.../2494421 ▾

Mar 5, 2012 – U.S. Navy Advances Dengue DNA Vaccine Using Vical Inc's ... dengue DNA vaccine formulated with the company's Vaxfectin adjuvant.

Vical Inc (VICL.O) Key Developments | Reuters.com

www.reuters.com/finance/stocks/VICL.O/key-developments ▾

U.S. Navy Advances Dengue DNA Vaccine Using Vical Inc's Vaxfectin Adjuvant Monday, 5 Mar 2012 06:30am EST. Vical Inc announced that the Naval Medical ...

Vical Says U.S. Navy Advances Dengue DNA Vaccine Using Its ...

www.rttnews.com/.../vical-says-u-s-navy-advances-dengue-dna-vaccine-... ▾

Mar 5, 2012 – Vical Inc. (VICL) said the Naval Medical Research Center, or NMRC, has ... Vical Says U.S. Navy Advances Dengue DNA Vaccine Using Its Vaxfectin Adjuvant ... DNA vaccine formulated with the company's Vaxfectin adjuvant.

Vical Says US Navy Advances Dengue DNA Vaccine Using Its ...

www.patriotfiles.com > The Patriot Files Forums > Military News > Navy ▾

Mar 5, 2012 - 2 posts

Vical Says US Navy Advances Dengue DNA Vaccine Using Its Vaxfectin Adjuvant RTT News (RTTNews) - Vical Inc. (VICL: News) said the ...

investors

INVESTORS

Home / Investors / News Releases / News Release Details

Print this Page | 

Overview

What's in Vical's DNA?

Stock Information

News Releases

Events & Presentations

SEC Filings

Briefcase

Fact Sheet

IR & Media Contacts

 ShareThis

U.S. Navy Advances Dengue DNA Vaccine Using Vical's Vaxfectin® Adjuvant

03/05/2012

SAN DIEGO, March 5, 2012 (GLOBE NEWSWIRE) – Vical Incorporated (Nasdaq:VICL) today announced that the Naval Medical Research Center (NMRC) has initiated a Phase 1 human clinical trial of a tetravalent dengue DNA vaccine formulated with the company's Vaxfectin® adjuvant. The trial is based on exciting efficacy data from a nonhuman primate study recently published in the journal *Vaccine*¹. Vical manufactured the vaccine and the adjuvant for both the preclinical and clinical studies, and is providing regulatory and clinical expertise to NMRC for the dengue program.

Vical completed three prior Phase 1 trials, with no safety issues and no dose-limiting toxicity, of Vaxfectin®-formulated DNA vaccines against H5N1 and H1N1 pandemic influenza.

Under a prior Collaborative Research and Development Agreement (CRADA) with Vical, NMRC developed a tetravalent DNA vaccine (TVDV) containing genes encoding the pre-membrane (prM) and envelope (E) proteins for all four serotypes of dengue virus, and formulated with Vical's Vaxfectin® adjuvant. Both Vaxfectin®-formulated and unformulated vaccines are now being evaluated in Phase 1 human testing. A total of 40 subjects will be assigned to three dose groups: a low dose TVDV without adjuvant, a low dose TVDV with Vaxfectin® adjuvant, or a high dose TVDV with Vaxfectin® adjuvant. Vaccines will be administered by intramuscular injections on days 0, 30 and 90, with follow-up through approximately one year. Key endpoints in the trial will be safety and immunogenicity.

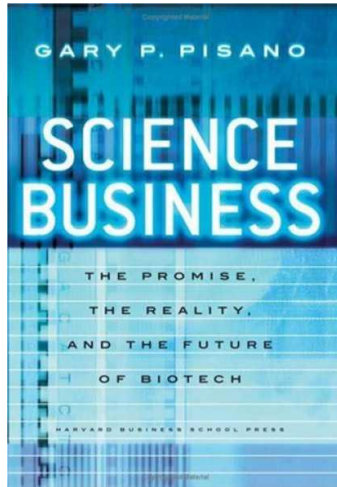
The recently published preclinical TVDV immunogenicity and challenge data indicated that Vaxfectin® significantly improved neutralizing antibody responses and significantly enhanced protection against challenge. Nonhuman primates received the tetravalent DNA vaccine, formulated with or without the Vaxfectin® adjuvant, or a blank DNA control, on days 0, 28, and 84. All four (100%) rhesus macaques receiving the Vaxfectin®-formulated vaccine developed neutralizing antibodies to all four serotypes of dengue by one month after the second injection, compared with none of the four (0%) macaques receiving the unformulated vaccine and none of the three (0%) unvaccinated control animals. By one month after the third injection, all (100%) macaques in both vaccine groups (Vaxfectin®-formulated and unformulated) developed neutralizing antibodies to all four serotypes of dengue, compared with none (0%) of the unvaccinated control animals.

Em relação a opiniões de experts...

E daí?

- Quais são os objetivos da instituição?
- Quais são as perguntas a serem respondidas?

Leitura Recomendada

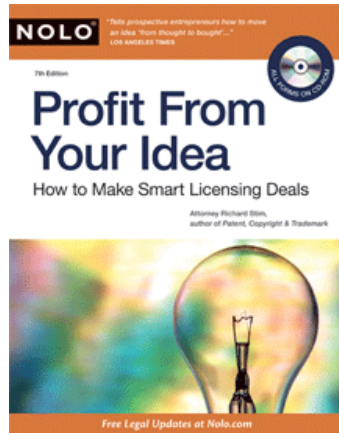


Science Business
Gary Pisano

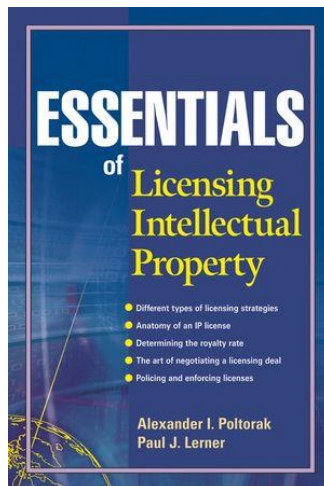


Patent It Yourself
David Pressman

Leitura Recomendada



Profit From Your Idea Richard Stim

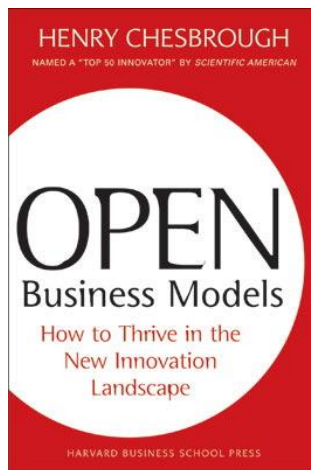


Essentials of Licensing Intellectual Property Alexander Poltorak & Paul Lerner

Leitura Recomendada



Open Innovation
Henry Chesbrough



Open Business Models
Henry Chesbrough



Muito obrigado pela atenção!

Henry Suzuki

henry.suzuki@axonal.com.br

Axonal Consultoria Tecnológica Ltda.

www.axonal.com.br



Oficina: Inovação Farmacêutica & Propriedade Intelectual

Universidade Federal do Espírito Santo
Vitória, ES
13 de agosto de 2018

Apoiadores



Mantenedores da Academia de Ciências Farmacêuticas do Brasil

Diamante:



Prata:

