



**CRF-AC**



# Oficina: Inovação Farmacêutica & Propriedade Intelectual

FAMETA  
Rio Branco, AC  
06 de abril de 2018

## Apoiadores



## Mantenedores da Academia de Ciências Farmacêuticas do Brasil

Diamante:



Prata:



# Uso Estratégico de Propriedade Intelectual e Informações Tecnológicas

## Foco no Setor Farmacêutico

FAMETA  
Rio Branco, AC  
06 de abril de 2018



**CRF-AC**





- **Ministrante**

**Henry Suzuki**

Sócio Diretor da Axonal Consultoria Tecnológica Ltda. (Brasil), Principal da Innovalyst LLC (Estados Unidos), Consultor Colaborador da Questel Consulting (França), Agente da Propriedade Industrial (INPI BR). Graduado em Farmácia e Bioquímica pela FCF-USP e pós-graduado em Administração de Empresas pela ESPM. Titular da Cadeira nº 2 da Academia Nacional de Farmácia. Empreendedor e Inventor. Membro da rede Mentores do Brasil.

henry.suzuki@axonal.com.br





# Uso Estratégico de Propriedade Intelectual e Informações Tecnológicas

## Foco no Setor Farmacêutico

- Agenda
  - Propriedade Intelectual no contexto farmacêutico, com destaque a patentes
  - Uso estratégico de patentes e informações patentárias
  - Ferramentas e técnicas de busca e análise de informações tecnológicas
  - Fontes, sistemas de busca e análise de informações com foco na área farmacêutica
  - Exemplo de mapeamento de segmento tecnológico

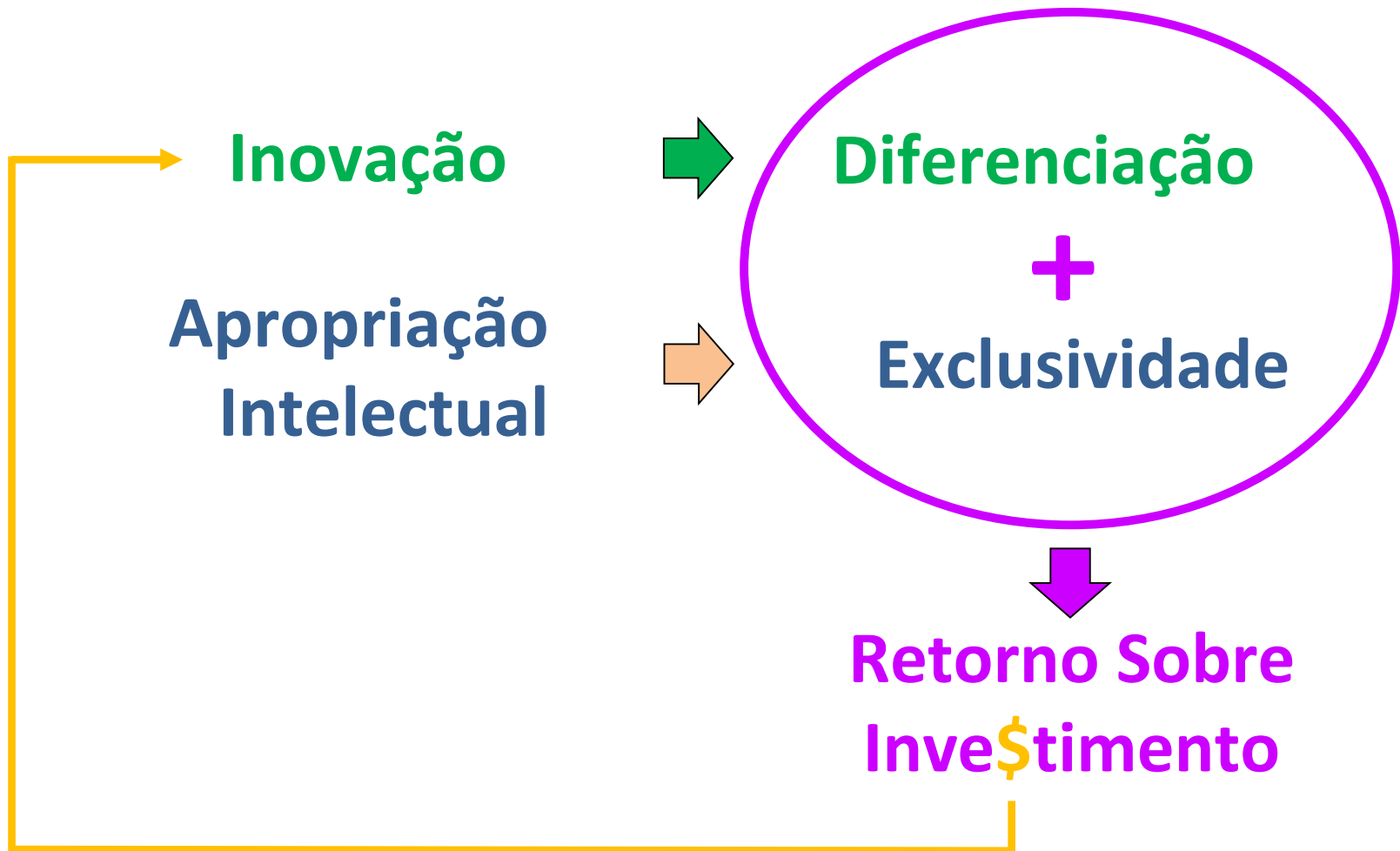


# Uso Estratégico de Propriedade Intelectual e Informações Tecnológicas

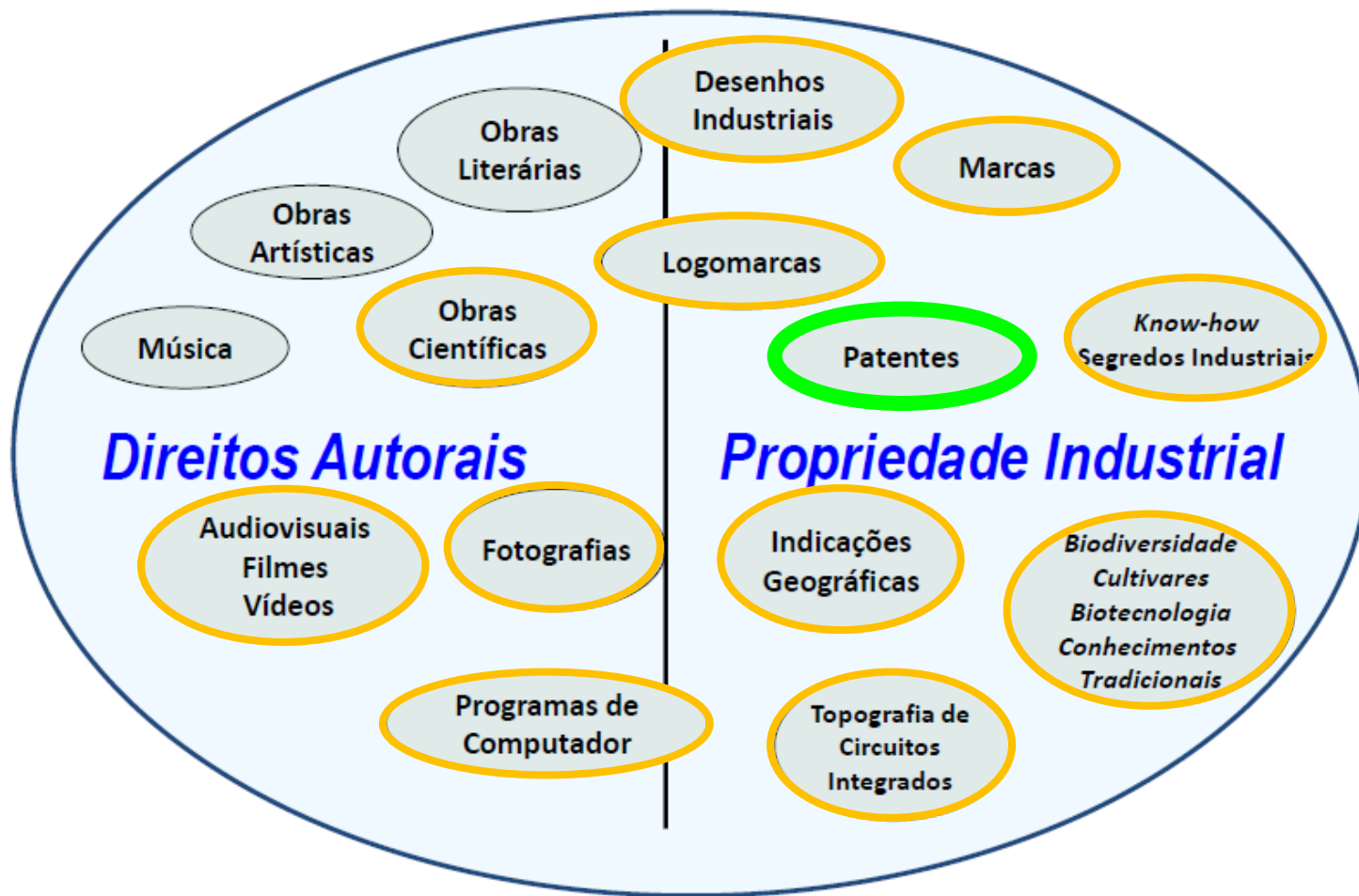
## Foco no Setor Farmacêutico

- Agenda
  - **Propriedade Intelectual no contexto farmacêutico, com destaque a patentes**
  - Uso estratégico de patentes e informações patentárias
  - Ferramentas e técnicas de busca e análise de informações tecnológicas
  - Fontes, sistemas de busca e análise de informações com foco na área farmacêutica
  - Exemplo de mapeamento de segmento tecnológico

# Inovação & Propriedade Intelectual



# Propriedade Intelectual em sua várias dimensões, com destaque a patentes



# Cartilha da Propriedade Intelectual 2015 – OAB-RS

[http://www.oabrs.org.br/arquivos/file\\_55d349cb980bb.pdf](http://www.oabrs.org.br/arquivos/file_55d349cb980bb.pdf)



## SUMÁRIO

|                                                                                              |         |
|----------------------------------------------------------------------------------------------|---------|
| OBRAS LITERÁRIAS.....                                                                        | 6 e 7   |
| OBRAS MUSICAIS.....                                                                          | 8 e 9   |
| OBRAS AUDIOVISUAIS.....                                                                      | 10 e 11 |
| OBRAS DE ARTES PLÁSTICAS E FOTOGRAFIAS.....                                                  | 12 e 13 |
| PROJETOS ARQUITETÔNICOS.....                                                                 | 14 e 15 |
| TRADUÇÕES E OBRAS DERIVADAS.....                                                             | 16 e 17 |
| ARTISTAS INTÉRPRETES OU EXECUTANTES, PRODUTORES FONOGRAFICOS E EMPRESAS DE RADIODIFUSÃO..... | 18 e 19 |
| PROGRAMAS DE COMPUTADOR.....                                                                 | 20 e 21 |
| INVENÇÕES.....                                                                               | 22 e 23 |
| MODELOS DE UTILIDADE.....                                                                    | 24 e 25 |
| DESIGN.....                                                                                  | 26 e 27 |
| KNOW HOW E SEGREDOS INDUSTRIAIS.....                                                         | 28 e 29 |
| TOPOGRAFIA DE CIRCUITOS INTEGRADOS.....                                                      | 30 e 31 |
| MARCAS.....                                                                                  | 32 e 33 |
| OBRAS PUBLICITÁRIAS.....                                                                     | 34 e 35 |
| MARCAS DE CERTIFICAÇÃO.....                                                                  | 36 e 37 |
| MARCAS COLETIVAS.....                                                                        | 38 e 39 |
| NOMES EMPRESARIAIS.....                                                                      | 40 e 41 |
| NOMES DE DOMÍNIO.....                                                                        | 42 e 43 |
| INDICAÇÕES GEOGRÁFICAS.....                                                                  | 44 e 45 |
| CULTIVARES.....                                                                              | 46 e 47 |
| CONCORRÊNCIA DESLEAL.....                                                                    | 48 e 49 |

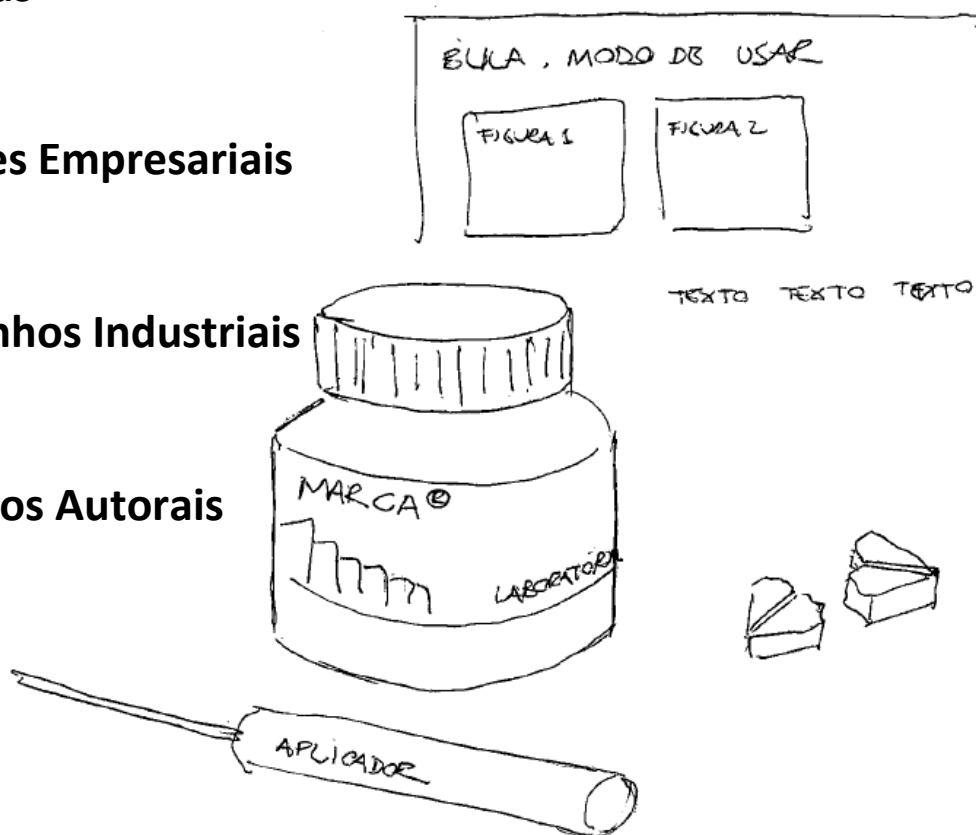
# Propriedade Intelectual em sua várias dimensões, com destaque a patentes

**Marcas**

**Nomes Empresariais**

**Desenhos Industriais**

**Direitos Autorais**



**Patentes**  
Molécula  
Processo de síntese  
Processo de purificação  
Sais  
Formas cristalinas  
Estabilização  
Fórmula farmacêutica  
Forma farmacêutica  
Acondicionamento  
Indicações  
Combinações  
Dispositivos

...

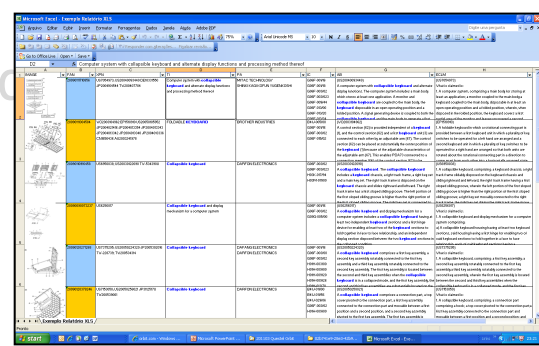
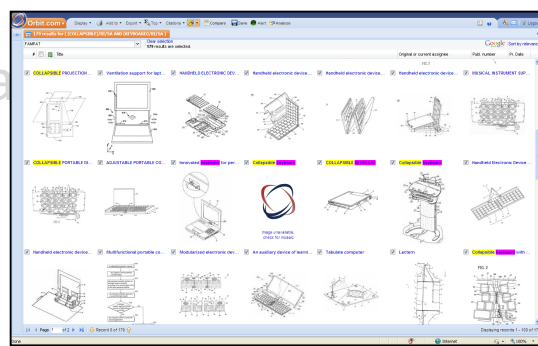
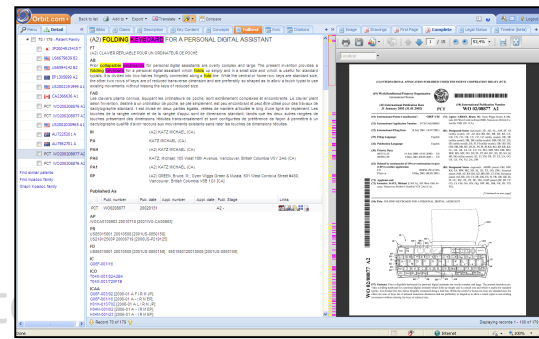
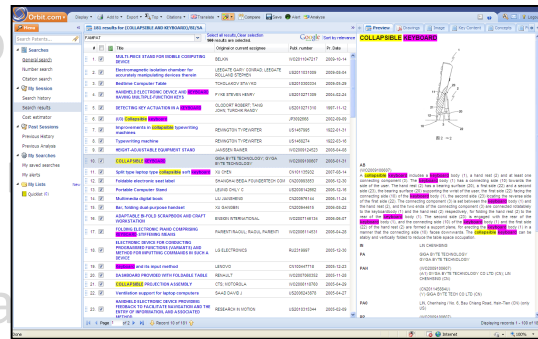
**Segredos industriais**

# Uso estratégico de patentes e informações patentárias

- Estudos de patenteabilidade e (in)validade
- Estudos de liberdade de comercialização
- Mapeamento de segmentos tecnológicos

O que?

- Invenção
- Patenteabilidade
- Monitoramento
- Identificação
- Etc.





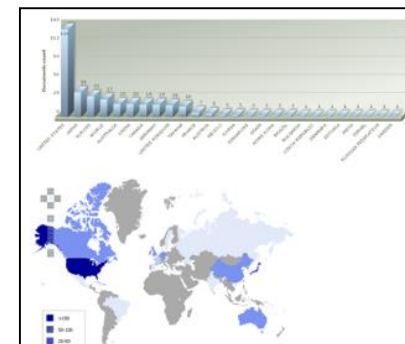
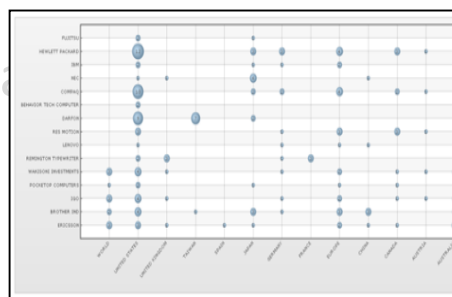
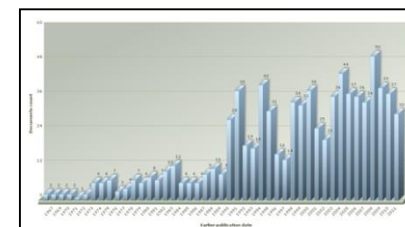
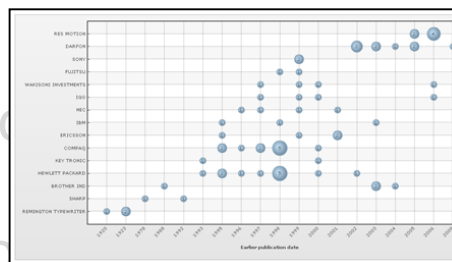
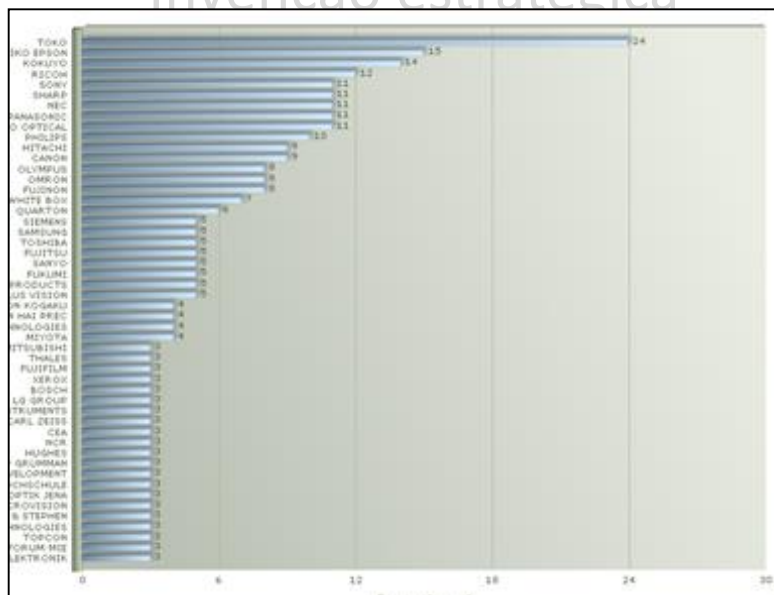
# Uso estratégico de patentes e informações patentárias

- Estudos de patenteabilidade e (in)validade
- Estudos de liberdade de comercialização
- Mapeamento de segmentos tecnológicos
- Invenção estratégica

Quem ?

Quando?

Onde?

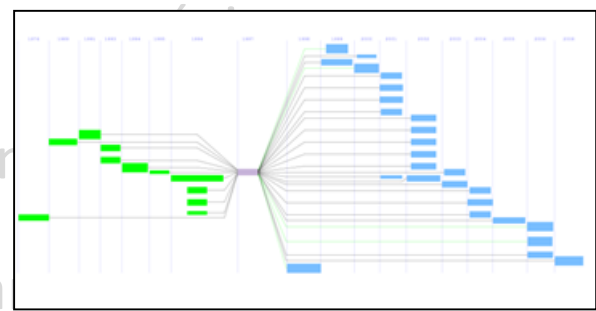
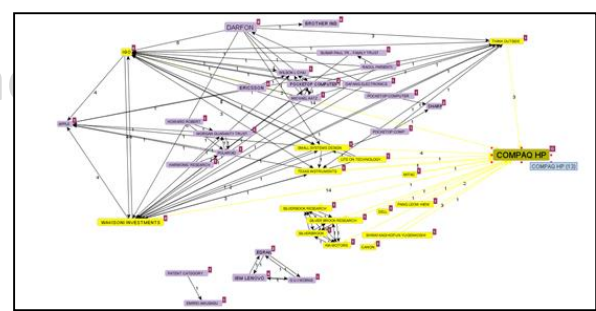


# Uso estratégico de patentes e informações patentárias

- Estudos de patenteabilidade e (in)validade
- Estudos de liberdade de comercialização
- Mapeamento de segmentos tecnológicos

Como?

- Invenção
- Patentear
- Monitorar
- Identificar
- Etc.

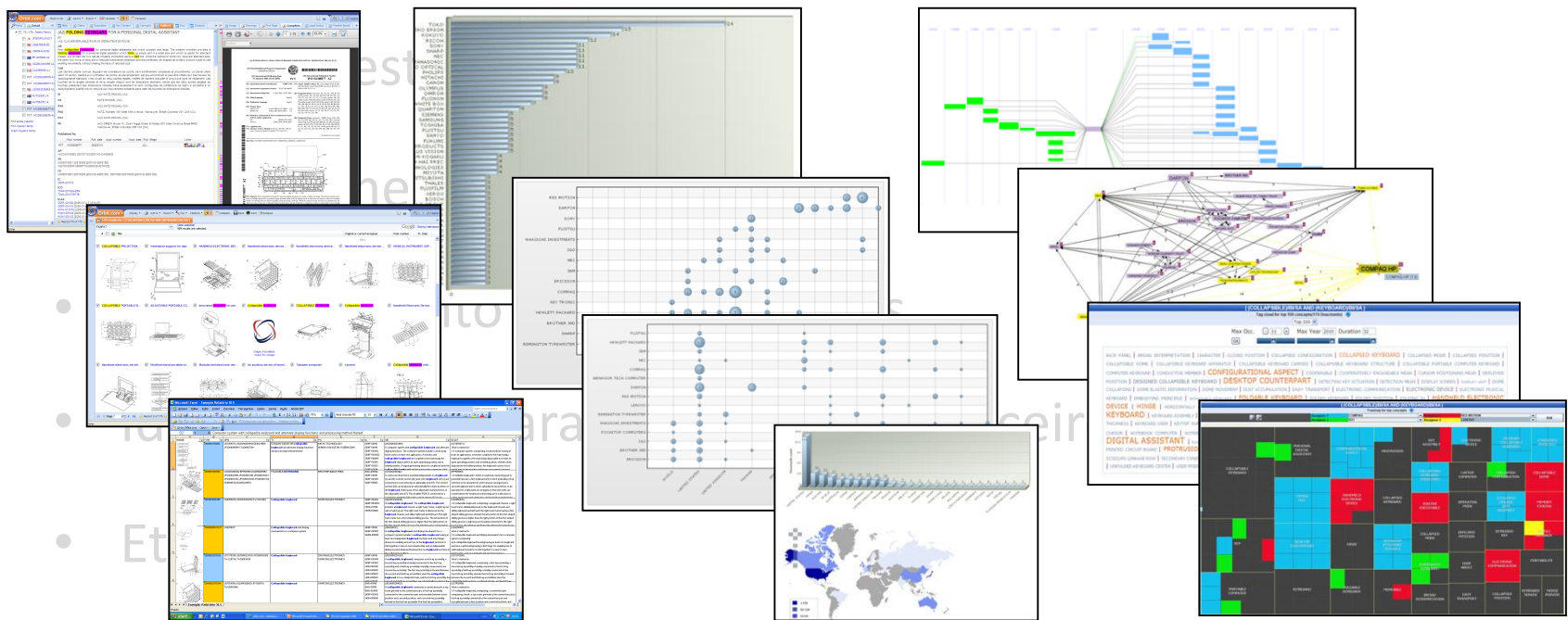



# Uso estratégico de patentes e informações patentárias

- Estudos de patenteabilidade e (in)validade
- Estudos de liberdade de comercialização
- Mapeamento de segmentos tecnológicos

Por quê?

E daí ?



# Propriedade Intelectual em sua várias dimensões, com destaque a patentes



- O que é patente
- O que é patenteável
- O que não é patenteável
- Como é um documento de patente
- Como definir o escopo de proteção
- Como é o processo de patenteamento

# Propriedade Intelectual em sua várias dimensões, com destaque a patentes



- O que é patente
- O que é patenteável
- O que não é patenteável
- Como é um documento de patente
- Como definir o escopo de proteção
- Como é o processo de patenteamento

# O que é patente



- Patente é um título de propriedade que confere ao seu titular o direito de impedir terceiros explorarem sua invenção, em um determinado território, por um limitado período de tempo, em troca da descrição da invenção.

# O que é patente



- Patente é um **título de propriedade** que confere ao seu titular direito de impedir terceiros explorarem sua invenção, em um determinado território, por um limitado período de tempo, em troca da descrição da invenção.

Lei da Propriedade Industrial nº 9.279/96

[http://www.planalto.gov.br/ccivil\\_03/leis/L9279.htm](http://www.planalto.gov.br/ccivil_03/leis/L9279.htm)

Diversos Tratados Internacionais





# Presidência da República

## Casa Civil

### Subchefia para Assuntos Jurídicos

#### LEI Nº 9.279, DE 14 DE MAIO DE 1996.

Regula direitos e obrigações relativos à propriedade industrial.

**O PRESIDENTE DA REPÚBLICA** Faço saber que o Congresso Nacional decreta e eu sanciono a seguinte Lei:

#### DISPOSIÇÕES PRELIMINARES

Art. 1º Esta Lei regula direitos e obrigações relativos à propriedade industrial.

Art. 2º A proteção dos direitos relativos à propriedade industrial, considerado o seu interesse social e o desenvolvimento tecnológico e econômico do País, efetua-se mediante:

I - concessão de patentes de invenção e de modelo de utilidade;

II - concessão de registro de desenho industrial;

III - concessão de registro de marca;

IV - repressão às falsas indicações geográficas; e

V - repressão à concorrência desleal.

# O que é patente



- Patente é um título de propriedade que confere ao seu titular o **direito de impedir terceiros explorarem sua invenção**, em um determinado território, por um limitado período de tempo, em troca da descrição da invenção.

Direito de Impedir Terceiros

≠

Direito de Explorar

## CAPÍTULO V

### DA PROTEÇÃO CONFERIDA PELA PATENTE

#### Seção I

#### Dos Direitos

Art. 41. A extensão da proteção conferida pela patente será determinada pelo teor das reivindicações, interpretado com base no relatório descritivo e nos desenhos.

**Art. 42. A patente confere ao seu titular o direito de impedir terceiro, sem o seu consentimento, de produzir, usar, colocar à venda, vender ou importar com estes propósitos:**

**I - produto objeto de patente;**

**II - processo ou produto obtido diretamente por processo patenteado.**

§ 1º Ao titular da patente é assegurado ainda o direito de impedir que terceiros contribuam para que outros pratiquem os atos referidos neste artigo.

§ 2º Ocorrerá violação de direito da patente de processo, a que se refere o inciso II, quando o possuidor ou proprietário não comprovar, mediante determinação judicial específica, que o seu produto foi obtido por processo de fabricação diverso daquele protegido pela patente.

Art. 43. O disposto no artigo anterior não se aplica:

**PATENTE (A) - HENRY**  
DISPOSITIVO PARA SENTAR  
CARACTERIZADO POR  
CONTER:

- QUATRO PÉS
- UM ASSENTO E
- UM ENCOSTO



**PATENTE (B) - ZÉ**  
DISPOSITIVO PARA SENTAR  
CONTENDO PELO MENOS  
UM PÉ E UM ASSENTO,  
CARACTERIZADO POR  
CONTER PELO MENOS UMA  
RODA DEBAIXO DE CADA PÉ



## **PATENTE (A) - HENRY**

DISPOSITIVO PARA SENTAR  
CARACTERIZADO POR  
CONTER:

- QUATRO PÉS
- UM ASSENTO E
- UM ENCOSTO



## **PATENTE (B) - ZÉ**

DISPOSITIVO PARA SENTAR  
CONTENDO PELO MENOS  
UM PÉ E UM ASSENTO,  
CARACTERIZADO POR  
CONTER PELO MENOS UMA  
RODA DEBAIXO DE CADA PÉ



**PATENTE (C) - MARIA**  
DISPOSITIVO PARA SENTAR  
CONTENDO PELO MENOS  
UM PÉ E UM ASSENTO,  
CARACTERIZADO POR  
CONTER ADICIONALMENTE  
PELO MENOS UM BRAÇO



**PATENTE (D) - JOANA**  
DISPOSITIVO PARA SENTAR  
CONTENDO PELO MENOS  
UM PÉ E UM ASSENTO E  
PELO MENOS UM BRAÇO,  
CARACTERIZADO POR  
CONTER, ADICIONALMENTE  
PELO MENOS UMA MESA  
LIGADA A UM DOS BRAÇOS



## **PATENTE (A) - HENRY**

DISPOSITIVO PARA SENTAR  
CARACTERIZADO POR  
CONTER:

- QUATRO PÉS
- UM ASSENTO E
- UM ENCOSTO

## **PATENTE (B) - ZÉ**

DISPOSITIVO PARA SENTAR  
CONTENDO PELO MENOS  
UM PÉ E UM ASSENTO,  
CARACTERIZADO POR  
CONTER PELO MENOS UMA  
RODA DEBAIXO DE CADA PÉ



## **PATENTE (D) - JOANA**

DISPOSITIVO PARA SENTAR  
CONTENDO PELO MENOS  
UM PÉ E UM ASSENTO E  
PELO MENOS UM BRAÇO,  
CARACTERIZADO POR  
CONTER, ADICIONALMENTE  
PELO MENOS UMA MESA  
LIGADA AO BRAÇO

## **PATENTE (C) - MARIA**

DISPOSITIVO PARA SENTAR  
CONTENDO PELO MENOS  
UM PÉ E UM ASSENTO,  
CARACTERIZADO POR  
CONTER ADICIONALMENTE  
PELO MENOS UM BRAÇO

# O que é patente



- Patente é um título de propriedade que confere ao seu titular direito de impedir terceiros explorarem sua invenção, **em um determinado território**, por um limitado período de tempo, em troca da descrição da invenção.

Para uma patente ter efeito em um determinado país, deverá ser depositada e concedida naquele país.

# O que é patente



- Patente é um título de propriedade que confere ao seu titular direito de impedir terceiros explorarem sua invenção, em um determinado território, **por um limitado período de tempo**, em troca da descrição da invenção.

Patente de Invenção: 20 Anos após o depósito  
ou pelo menos 10 anos após a concessão

Patente de Modelo de Utilidade: 15 Anos após o depósito  
ou pelo menos 7 anos após a concessão

# O que é patente



- Patente é um título de propriedade que confere ao seu titular o direito de impedir terceiros explorarem sua invenção, em um determinado território, por um limitado período de tempo, **em troca da descrição da invenção.**

O escopo de proteção de uma patente depende da descrição da invenção. Em determinados casos, a manutenção de segredo industrial pode ser mais adequada.

## Das Condições do Pedido

Art. 22. O pedido de patente de invenção terá de se referir a uma única invenção ou a um grupo de invenções inter-relacionadas de maneira a compreenderem um único conceito inventivo.

Art. 23. O pedido de patente de modelo de utilidade terá de se referir a um único modelo principal, que poderá incluir uma pluralidade de elementos distintos, adicionais ou variantes construtivas ou configurativas, desde que mantida a unidade técnico-funcional e corporal do objeto.

Art. 24. O relatório deverá descrever clara e suficientemente o objeto, de modo a possibilitar sua realização por técnico no assunto e indicar, quando for o caso, a melhor forma de execução.

Parágrafo único. No caso de material biológico essencial à realização prática do objeto do pedido, que não possa ser descrito na forma deste artigo e que não estiver acessível ao público, o relatório será suplementado por depósito do material em instituição autorizada pelo INPI ou indicada em acordo internacional.

Art. 25. As reivindicações deverão ser fundamentadas no relatório descritivo, caracterizando as particularidades do pedido e definindo, de modo claro e preciso, a matéria objeto da proteção.

# Propriedade Intelectual em sua várias dimensões, com destaque a patentes



- O que é patente
- **O que é patenteável**
- O que não é patenteável
- Como é um documento de patente
- Como definir o escopo de proteção
- Como é o processo de patenteamento



## DAS INVENÇÕES E DOS MODELOS DE UTILIDADE PATENTEÁVEIS

**Art. 8º** É patenteável a invenção que atenda aos requisitos de novidade, atividade inventiva e aplicação industrial.

Art. 9º É patenteável como modelo de utilidade o objeto de uso prático, ou parte deste, suscetível de aplicação industrial, que apresente nova forma ou disposição, envolvendo ato inventivo, que resulte em melhoria funcional no seu uso ou em sua fabricação.

Art. 10. Não se considera invenção nem modelo de utilidade:

I - descobertas, teorias científicas e métodos matemáticos;

II - concepções puramente abstratas;

III - esquemas, planos, princípios ou métodos comerciais, contábeis, financeiros, educativos, publicitários, de sorteio e de fiscalização;

IV - as obras literárias, arquitetônicas, artísticas e científicas ou qualquer criação estética;

# O que é patenteável



- É patenteável a invenção que atenda aos requisitos de novidade, atividade inventiva e aplicação industrial.

# O que é patenteável



- É patenteável a invenção que atenda aos requisitos de **novidade**, atividade inventiva e aplicação industrial.

Art. 11. A invenção e o modelo de utilidade são considerados novos quando não compreendidos no estado da técnica.

§ 1º O estado da técnica é constituído por tudo aquilo tornado acessível ao público antes da data de depósito do pedido de patente, por descrição escrita ou oral, por uso ou qualquer outro meio, no Brasil ou no exterior, ressalvado o disposto nos arts. 12, 16 e 17.

§ 2º Para fins de aferição da novidade, o conteúdo completo de pedido depositado no Brasil, e ainda não publicado, será considerado estado da técnica a partir da data de depósito, ou da prioridade reivindicada, desde que venha a ser publicado, mesmo que subsequente.

§ 3º O disposto no parágrafo anterior será aplicado ao pedido internacional de patente depositado segundo tratado ou convenção em vigor no Brasil, desde que haja processamento nacional.

Art. 12. Não será considerada como estado da técnica a divulgação de invenção ou modelo de utilidade, quando ocorrida durante os 12 (doze) meses que precederem a data de depósito ou a da prioridade do pedido de patente, se promovida:

I - pelo inventor;

II - pelo Instituto Nacional da Propriedade Industrial - INPI, através de publicação oficial do pedido de patente depositado sem o consentimento do inventor, baseado em informações deste obtidas ou em decorrência de atos por ele realizados; ou

# O que é patenteável



- É patenteável a invenção que atenda aos requisitos de novidade, **atividade inventiva** e aplicação industrial.

**Art. 13.** A invenção é dotada de atividade inventiva sempre que, para um técnico no assunto, não decorra de maneira evidente ou óbvia do estado da técnica.

Art. 14. O modelo de utilidade é dotado de ato inventivo sempre que, para um técnico no assunto, não decorra de maneira comum ou vulgar do estado da técnica.

# O que é patenteável



- É patenteável a invenção que atenda aos requisitos de novidade, atividade inventiva e **aplicação industrial.**

Art. 15. A invenção e o modelo de utilidade são considerados suscetíveis de aplicação industrial quando possam ser utilizados ou produzidos em qualquer tipo de indústria.



# Propriedade Intelectual em sua várias dimensões, com destaque a patentes



- O que é patente
- O que é patenteável
- **O que não é patenteável**
- Como é um documento de patente
- Como definir o escopo de proteção
- Como é o processo de patenteamento

## Das Invenções e Dos Modelos de Utilidade Não Patenteáveis

Art. 18. Não são patenteáveis:

I - o que for contrário à moral, aos bons costumes e à segurança, à ordem e à saúde públicas;

II - as substâncias, matérias, misturas, elementos ou produtos de qualquer espécie, bem como a modificação de suas propriedades físico-químicas e os respectivos processos de obtenção ou modificação, quando resultantes de transformação do núcleo atômico; e

III - o todo ou parte dos seres vivos, exceto os microorganismos transgênicos que atendam aos três requisitos de patenteabilidade - novidade, atividade inventiva e aplicação industrial - previstos no art. 8º e que não sejam mera descoberta.

Parágrafo único. Para os fins desta Lei, microorganismos transgênicos são organismos, exceto o todo ou parte de plantas ou de animais, que expressem, mediante intervenção humana direta em sua composição genética, uma característica normalmente não alcançável pela espécie em condições naturais.

Art. 10. Não se considera invenção nem modelo de utilidade:

I - descobertas, teorias científicas e métodos matemáticos;

II - concepções puramente abstratas;

III - esquemas, planos, princípios ou métodos comerciais, contábeis, financeiros, educativos, publicitários, de sorteio e de fiscalização;

IV - as obras literárias, arquitetônicas, artísticas e científicas ou qualquer criação estética;

V - programas de computador em si;

VI - apresentação de informações;

VII - regras de jogo;

VIII - técnicas e métodos operatórios ou cirúrgicos, bem como métodos terapêuticos ou de diagnóstico, para aplicação no corpo humano ou animal; e

IX - o todo ou parte de seres vivos naturais e materiais biológicos encontrados na natureza, ou ainda que dela isolados, inclusive o genoma ou germoplasma de qualquer ser vivo natural e os processos biológicos naturais.

# Propriedade Intelectual em sua várias dimensões, com destaque a patentes



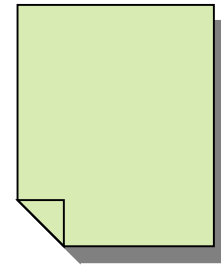
- O que é patente
- O que é patenteável
- O que não é patenteável
- **Como é um documento de patente**
- Como definir o escopo de proteção
- Como é o processo de patenteamento

# Como é um documento de patente



Publicações de patentes têm uma estrutura padronizada, composta por:

- Titular
- Inventor
- Classificação
- Prioridade
- Anterioridades
- Resumo
- Relatório descritivo
- Reivindicações
- Desenhos (eventualmente)





US007146667B2

(12) **United States Patent**  
**Elsener**

(10) **Patent No.:** US 7,146,667 B2  
(45) **Date of Patent:** Dec. 12, 2006

(54) **POCKET TOOL**  
(75) Inventor: **Carl Elsener**, Ibach (CH)  
(73) Assignee: **Victorinox AG**, Ibach (CH)  
(\* ) Notice: Subject to any disclaimer, the term of this patent is extended or adjusted under 35 U.S.C. 154(b) by 0 days.

(21) Appl. No.: **10/965,638**  
(22) Filed: **Oct. 14, 2004**

(65) **Prior Publication Data**  
US 2005/0081302 A1 Apr. 21, 2005

(30) **Foreign Application Priority Data**  
Oct. 17, 2003 (AT) ..... A 1650/2003

(51) **Int. Cl.**  
**B26B 11/00** (2006.01)  
(52) **U.S. Cl.** ..... 7/118; 7/170  
(58) **Field of Classification Search** ..... 7/118,  
7/158, 170; 81/177.4; 365/200  
See application file for complete search history.

(56) **References Cited**  
**U.S. PATENT DOCUMENTS**  
4,854,045 A \* 8/1989 Schaub ..... 30/155  
6,273,582 B1 \* 8/2001 Taggart et al. .... 362/119

6,341,423 B1 \* 1/2002 Taggart et al. .... 30/169  
6,394,813 B1 \* 5/2002 Stout et al. .... 439/11  
6,561,421 B1 \* 5/2003 Yu ..... 235/451  
6,675,419 B1 \* 1/2004 Rivera ..... 7/128  
2004/0080989 A1 \* 4/2004 Yu ..... 365/200

**FOREIGN PATENT DOCUMENTS**

JP 2003 - 10570 1/2003

\* cited by examiner

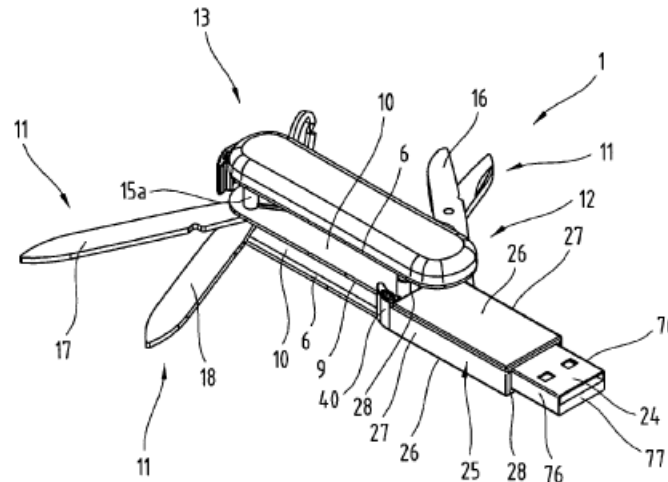
*Primary Examiner*—David B. Thomas

(74) *Attorney, Agent, or Firm*—Fross Zelnick Lehrman & Zissu, P.C.; Philip T. Shannon, Esq.; Charles T. J. Weigell, Esq.

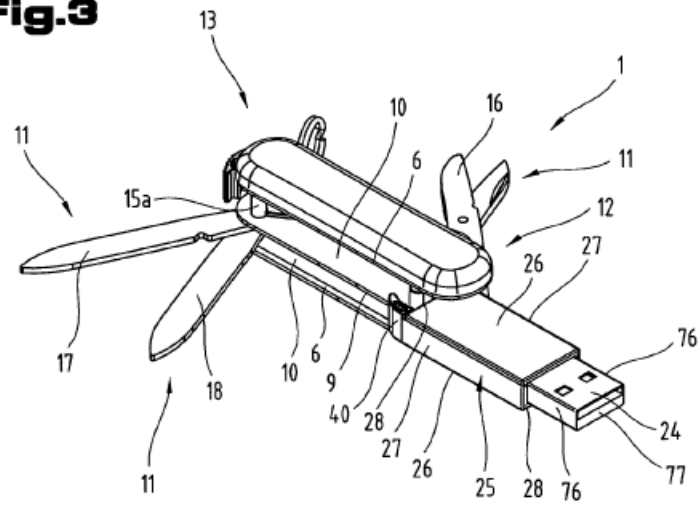
(57) **ABSTRACT**

The invention specifies a pocket tool, particularly a pocket knife (1) or plate-like tool card, comprising a housing (2) with at least one receiving area (10), and at least two functional components (11) movable from a storage position within the receiving area (10), into a working position outside of the receiving area (10). The first functional component (11) is designed as a tool, particularly a pair of scissors (16) or knife (1). The second functional component (11) has a support casing (25) and is equipped with a recordable and readable, nonvolatile memory, as well as with an interface (24). A releasable locking device and a longitudinal guide or pivot bearing are arranged between the support casing (25) of the second functional component (11) and the housing (2).

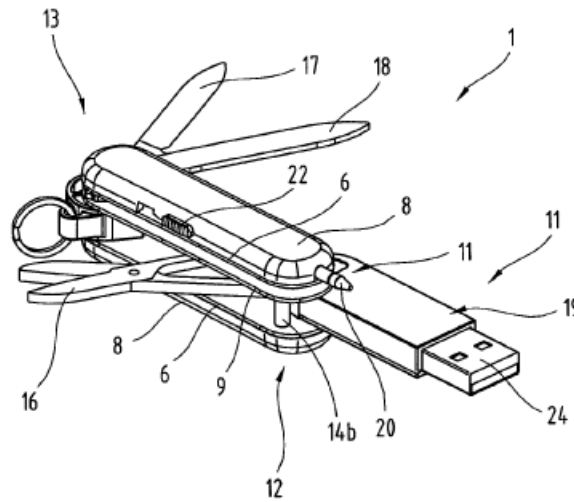
118 Claims, 14 Drawing Sheets



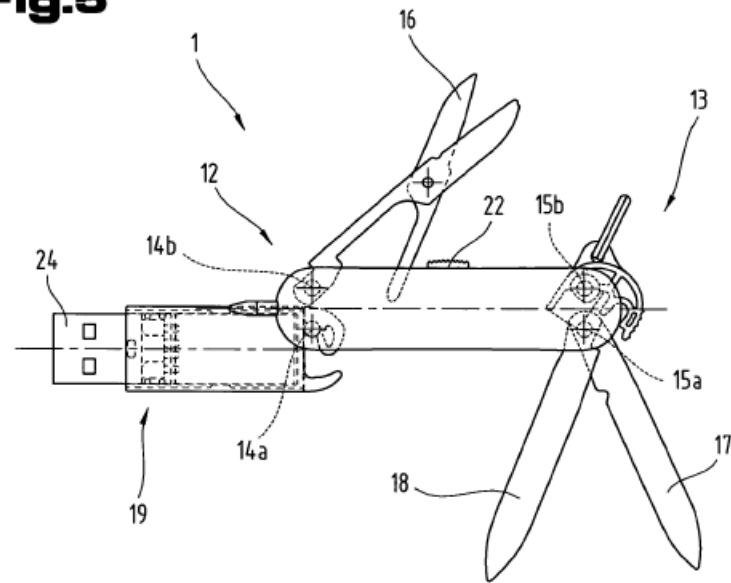
**Fig. 3**



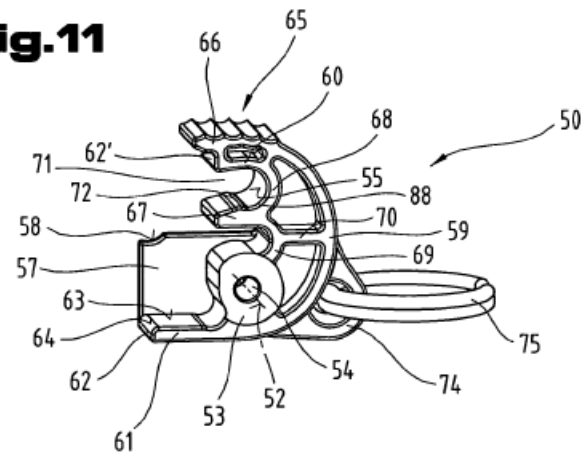
**Fig. 4**



**Fig. 5**

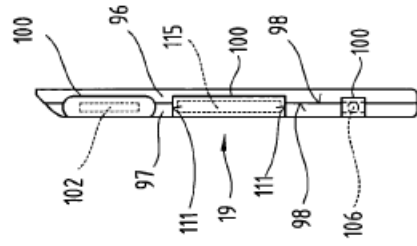


**Fig. 11**

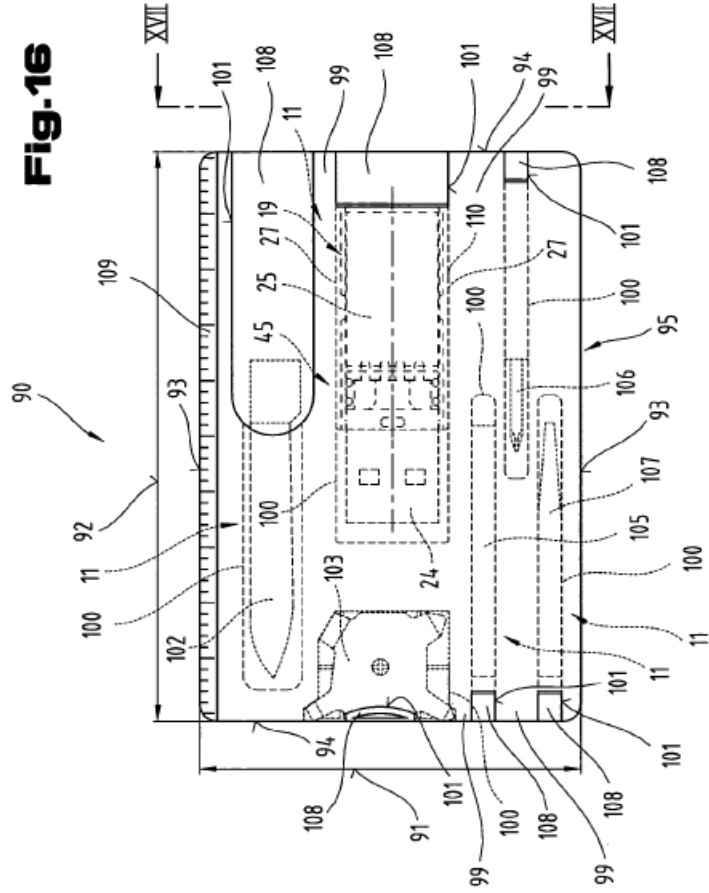




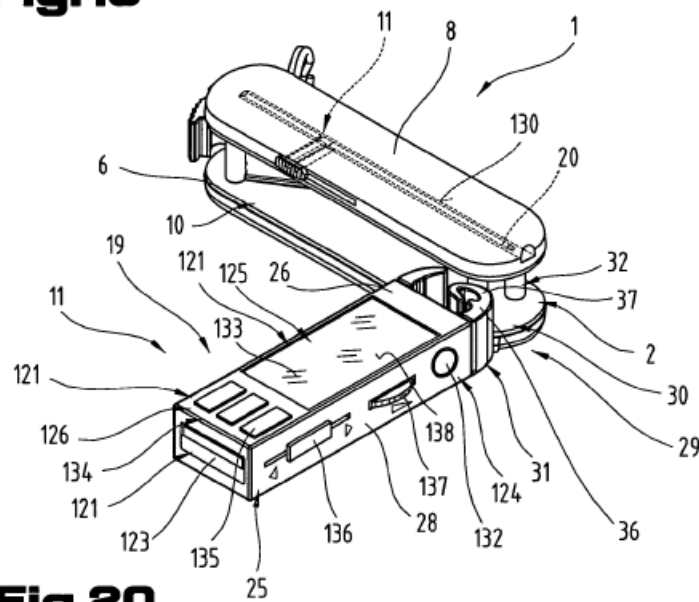
**Fig. 17**



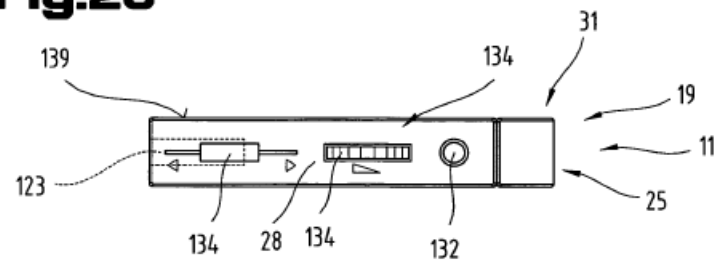
**Fig. 16**



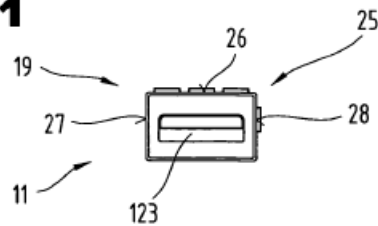
**Fig.19**



**Fig.20**



**Fig.21**



**1**  
**POCKET TOOL**

CROSS REFERENCE TO RELATED  
APPLICATIONS

Applicant claims priority under 35 U.S.C. §119 of AUSTRALIAN Patent Application No. A 1659/2003 filed on Oct. 17, 2003.

BACKGROUND OF THE INVENTION

1. Field of the Invention

The invention relates to a pocket tool as defined in the introductory parts of claims 1 and 44. Furthermore, it relates to a functional component as defined in the introductory part of claim 116.

2. The Prior Art

Different designs of pocket tools in the form of pocket knives or plate-shaped tool cards are known from WO 01/39629 A1 and CH 686 173 A5. Such tools comprise a housing with at least one receiving area and a number of functional components that are movable from a storage position within the receiving area, to a working position outside of the receiving area. On the one hand, such functional components are formed by tools such as, for example a pair of scissors, a knife, a screwdriver and the like, and by utensils such as, for example tooth picks, pincers or cleaning needles, on the other hand. The functionality of such known pocket tools is extended in that a battery-buffered random access memory (RAM) main memory, or a read-only memory (ROM) memory is arranged within the housing. Said memories are arranged locally fixed in the pocket knife. Programs or data can be stored in and recalled from such memories. The main memory is referred to also as a so-called volatile storage because it has to be supplied with the required voltage, so it will not lose the memory contents even if the supply voltage is shut off. Arranging the required battery in the housing leads to an overall enlargement of the size of the pocket tool, or that only a few functional components can be arranged in the housing with comparatively no change in the outside dimensions.

If the memory is designed as a ROM memory, data can only be read out from the memory; however, no data can be written into the memory, which means the user can exclusively utilize the data or programs preset by the manufacturer of the pocket tool, which highly restricts the field of application of such a pocket tool.

Furthermore, a multifunctional tool is known from WO 99/56918 A1, which has at least one measuring, input and display device for at least one physical quantity, said device being arranged in or on the tool. The display device may be formed in this connection by an LCD display serving for the visual output of physical quantities. The measuring and display device can be supplied with current by means of a battery and/or a solar cell. Furthermore, provision may be made in or on the tool for an interface in order to input data for the measuring and display device, and to transmit data from the latter. For converting the measured and/or input value into an electrical signal, provision can be made for a converter or microprocessor for converting the electrical signal into a standardized physical unit.

Such a multifunctional tool does in fact extend the functionality of a pocket knife or manual tool; however, the scope of functions is exclusively limited to the processing of detectable measured physical values.

The pocket tools known from the prior art are generally found to be lacking with respect to their capability of

**2**

processing digital data and outputting the latter in a form the user can detect, so there is a demand for additionally extending the scope of functions of pocket tools, while maintaining at the same time in the usual manner the scope of functions to which the user is accustomed to, such functions being achievable with functional tools or components such as, e.g. screwdrivers, knives, scissors, and utensils such as, e.g. toothpicks etc.

SUMMARY OF THE INVENTION

The present invention is based on the problem to extend the range of application of a pocket tool without influencing thereby the dimensions of the pocket tool as such. A part problem of the present invention consists in expanding the scope of functions and the range of application of the pocket tool with respect to its capability of processing digital data, the objective being to maintain the mechanical functionality through the availability of tools and utensils.

The problem of the invention is resolved by the features defined herein. The benefits resulting from said features include that the second functional component in the form of an electronic module can be moved for its application into a position outside of the receiving range of the pocket tool, achieving in this manner superior accessibility particularly to the interface. In the nonvolatile storage, it is possible to write in and read out data, for example text data or data as video and language information and the like, and programs, e.g. application programs and the like, whereby the non-volatile storage is wherein contrary to the known volatile main memories, where data and programs can be read in and written out as well, the electrical energy supply can be dispensed with, and the space volume otherwise required for accommodating, e.g. a battery in the housing, can be used either as an additional storage space or for additional tools. The functionality of the pocket tools, and in particular the memory capacity or the range of application as a tool can be significantly raised in this way without substantially increasing its outside dimensions. It is advantageous also that a releasable locking device is arranged between the functional component and the housing, because any unintentional removal of the functional component from its storage position, for example, is excluded to the greatest possible extent. The longitudinal guide or pivot-mount between the support casing of the second functional component, and the housing of the pocket tool effect a smooth movement of the second functional component vis-à-vis the receiving area or a bearing axle arranged in the housing.

One embodiment is advantageous in that, on the one hand, the memory and the control circuit and/or at least one peripheral are arranged within the support casing, which is enclosed on all sides and consequently protected from environmental influences such as, e.g. moisture, dust and the like; and that the support casing has high mechanical stability and is insensitive to pressure stress, on the other hand. The interface represents a link between the memory and an external EDP system.

As disclosed, it is also possible to maintain a standardized length of a pocket tool known in the prior art.

Beneficial sequence activities for the second functional component are also disclosed.

Further developments of the invention are advantageous in that the second functional component forming the electronics module is, in its working position, now completely separated from the housing, and can be used independently of the latter. Particularly the increasingly stricter security regulations in airline traffic prohibit passengers from using

be parameterized in a manner simple for the user. Particularly intuitive and user-friendly control is feasible via a user surface allotted to the controlling device, and by means of an electronic position detection system, particularly a touch screen, it is possible to provide a particularly compact structure of the control circuit, display and controlling device with just a few individual components.

Other useful exemplified embodiments of the pocket tool are disclosed that provide for simple controllability and adjustability of the functions of the control circuit.

Another useful embodiment of a peripheral, whereby it is advantageous particularly on account of an energy supply device formed by a self-sufficient energy storage according to claim 112, is that the pocket tool is not restricted in its mobility, and that the control circuit can be operated substantially without being dependent on any location. Particularly chemoelectrical energy storage means and especially rechargeable batteries can be employed in this connection, for example such as lithium or lithium-polymer accumulators, or one-way batteries.

Furthermore, a disclosed design variation is beneficial in that owing to the energy supply system provided in the pocket tool in the form of electrical conductors, the pocket tool either does not require its own energy storage means because electrical energy is supplied to the control circuit and to peripherals via the electrical conductors, or the energy storage means arranged in the pocket tool is rechargeable via the electrical conductors.

The invention further contemplates and discloses advantageous design variations for arranging the control circuit and at least one peripheral.

A further, independent solution to the problem as defined by the invention relates to another disclosed functional component. The benefit ensuing therefrom lies mainly in the fact that the first coupling component of the functional component serving for the connection to the other coupling component, comprises at the same time the bearing component, forming a pivot-mounted bearing site. The capability of the functional component of swiveling out of a receiving area in the housing of the pocket tool is therefore provided via the first coupling component, and the functional component can be released from the housing of the pocket tool in its swiveled-out condition.

#### BRIEF DESCRIPTION OF THE DRAWINGS

The invention is explained in greater detail in the following with the help of the exemplified embodiments shown in the drawings, in which:

FIGS. 1 and 2 show perspective views of the pocket knife as defined by the invention, with an electronics module set to the storage position within the receiving area.

FIGS. 3 and 4 show perspective views of the pocket knife according to FIGS. 1 and 2, with the tools swiveled out, and the electronics module swiveled out into the position in which it is used.

FIG. 5 is a side view of the pocket knife according to FIG. 4.

FIG. 6 is a side view of the pocket knife according to FIG. 2.

FIG. 7 is a section along lines VII—VII in FIG. 6.

FIG. 8 is a perspective view of the pocket knife with the electronics module set to a removal position.

FIG. 9 is a side view of the pocket knife according to FIG. 8.

FIG. 10 shows an enlargement of a cutout of the pocket knife according to FIG. 9, with the pivot-mount arranged

between the support casing of the electronics module and the housing of the pocket knife, as well as its coupling device with a first design of the coupling components.

FIG. 11 is a perspective view of the closing cap for protecting the interface of the electronics module, the latter being fully pivoted into its storage position.

FIG. 12 is another side view and simplified representation of a coupling component of the coupling device of the pivot bearing.

FIG. 12a is a side view of a part section of the pocket knife with another design of a pivot bearing, and of a part section of the electronics module, the latter being inseparable from the housing.

FIG. 13 is a perspective view of the pocket knife, with the electronics module completely detached and separated from its casing.

FIG. 14 is a side view of the pocket knife and electronics module shown in a preliminary position prior to coupling it with the second coupling component of the housing.

FIG. 15 is a side view of a part section of the pocket knife and electronics module in a preliminary position prior to uncoupling it from the second coupling component of the housing.

FIG. 16 is a top view of a plate-like tool card shown by a highly simplified representation.

FIG. 17 is a highly simplified view of the tool card according to FIG. 16 according to lines XVII—XVII.

FIG. 18 is a longitudinal section and highly simplified representation of another possible design variation of a locking device disposed between the support casing of the electronics module and the housing of the tool card.

FIG. 19 is a perspective view of another design variation of the pocket knife with an electronics module comprising a control circuit and peripherals.

FIG. 20 is a side view of the electronics module according to FIG. 19.

FIG. 21 is a front view of the electronics module according to FIG. 19.

FIG. 22 shows a block diagram of the control circuit with different peripherals connected to said circuit.

FIG. 23 is a perspective view of another design variation of the pocket knife, with electronic components integrated in the housing.

FIG. 24 is a perspective view of another design variation of the pocket knife, with an electronics module detachable from the housing, and with electronic components arranged in the housing of the pocket tool.

FIG. 25 is a top view of a possible design variation of the pocket knife, with a plate-like electronics module.

FIG. 26 is a perspective view of another design variation of the pocket knife, with an external controlling unit for controlling the control circuit, and an external data medium.

FIG. 27 is a perspective view of yet another design variation of the pocket knife, with a plurality of electronics modules equipped in different ways.

FIG. 28 is a perspective view of yet another design variation of the pocket knife, with input/output devices provided on the cover plate; and

FIG. 29 is a perspective view of a possible design variation of a tool card comprising the electronics module.

#### DETAILED DESCRIPTION OF PREFERRED EMBODIMENTS

It is noted herewith by way of introduction that in the different embodiments described herein, identical components are provided with identical reference numerals and

-continued

## LIST OF REFERENCE NUMERALS

|     |                           |
|-----|---------------------------|
| 70  | Connection wall           |
| 71  | Receiving slot            |
| 72  | Detent nose               |
| 73  | Locking device            |
| 74  | Flange                    |
| 75  | Key ring                  |
| 76  | Narrow-side wall          |
| 77  | Face side                 |
| 78  | Angle                     |
| 79  | Pivot bearing area        |
| 80  | Bearing bore              |
| 81  | Adapter                   |
| 82  | Plug socket               |
| 83  | Arrow                     |
| 84  | Arrow                     |
| 85  | Arrow                     |
| 86  | Arrow                     |
| 88  | Depression                |
| 90  | Tool card                 |
| 91  | Width                     |
| 92  | Length                    |
| 93  | Longitudinal side surface |
| 94  | Transverse side surface   |
| 95  | Housing                   |
| 96  | Base plate                |
| 97  | Cover plate               |
| 98  | Side surface              |
| 99  | Partition                 |
| 100 | Receiving area            |
| 101 | Receiving opening         |
| 102 | Knife                     |
| 103 | Multifunctional tool      |
| 105 | Pincers                   |
| 106 | Phillips screwdriver      |
| 107 | Toothpick                 |
| 108 | Handle                    |
| 109 | Rule                      |
| 110 | Longitudinal guide        |
| 111 | Guide surface             |
| 112 | Side surface              |
| 113 | Detent nose               |
| 114 | Detent deepening          |
| 115 | Memory card               |
| 120 | Control circuit           |
| 121 | Peripheral                |
| 122 | Storage element           |
| 123 | Data interface            |
| 124 | Input/output interface    |
| 125 | Input/output device       |
| 126 | Operating system          |
| 127 | Energy supply system      |
| 128 | Signal and/or data bus    |
| 129 | Storage element           |
| 130 | Longitudinal guide        |
| 131 | Plug socket               |
| 132 | Jack                      |
| 133 | Display                   |
| 134 | Input element             |
| 135 | Key elements              |
| 136 | Sliding key               |
| 137 | Controller                |
| 138 | Representation zone       |
| 139 | Outside surface           |
| 140 | Broad side                |
| 141 | Narrow side               |
| 142 | Face side                 |
| 143 | Module frame              |
| 144 | Coupling device           |
| 145 | Coupling element          |
| 146 | Coupling element          |
| 147 | Contact element           |
| 148 | Contact element           |
| 149 | Bus interface             |
| 150 | Riveted pin               |
| 151 | Operating unit            |
| 152 | Transmission line         |
| 153 | Loudspeaker               |

-continued

## LIST OF REFERENCE NUMERALS

|    |     |                             |
|----|-----|-----------------------------|
| 5  | 154 | Mass storage                |
|    | 155 | Transmitter and/or receiver |
|    | 156 | Connection system           |
|    | 157 | Snap arm                    |
|    | 158 | Recess                      |
| 10 | 159 | Picture detection system    |
|    | 160 | Sound pick-up               |

What is claimed is:

1. A pocket tool, particularly a pocket knife or plate-like tool card, comprising a housing with at least one receiving area, and at least two functional components moveable from a storage position within the receiving area, into a working position outside of the receiving area, of which a first functional component is designed as a tool, particularly a pair of scissors, a knife or a utensil, in particular a toothpick, pincers, cleaning needle, writing pen, wherein a second functional component has a support casing and is equipped with a recordable and readable, nonvolatile memory, as well as an interface; and at least one releasable locking device and a longitudinal guide or a pivot bearing are arranged between the support bearing of the second functional component, and the housing.

2. The pocket tool according to claim 1, wherein the particularly oblong support casing of the second functional component comprises two parallel broad-side walls opposing one another; two parallel narrow-side walls extending substantially vertically between the broad-side walls and opposing one another; as well as two narrow-side walls opposing each other on the face side; and the memory is arranged within the support casing and the interface on one of the narrow-side walls on the face side.

3. The pocket tool according to claim 1, wherein the second functional component has only a part of the length of the housing.

4. The pocket tool according to claim 1, wherein the second functional component is adapted to pivot.

5. The pocket tool according to claim 1, wherein the second functional component is extractable.

6. The pocket tool according to claim 1, wherein the second functional component is separable from the housing.

7. The pocket tool according to claim 1, wherein the pivot bearing is equipped with a coupling device comprising coupling components engageable with and releasable from each other, whereby the support casing is provided with the first coupling component in one of its end areas, and the housing with the second coupling component in one of its face-side end areas.

8. The pocket tool according to claim 7, wherein the second coupling component is formed by a bearing axle, particularly a connection pin immovably arranged in the housing and extending perpendicular to the broad-side walls of the support casing.

9. The pocket tool according to claim 7, wherein the second coupling component is formed by an adapter pivot-mounted on the bearing axle immovably arranged in the housing and extending perpendicular to the broad-side walls of the support casing.

10. The pocket tool according to claim 9, wherein the adapter and the support casing each have at least one plug or detent or snap element; and that the second functional component is releasably connected with the adapter via a plug or detent or snap connection.

What is claimed is:

15 1. A pocket tool, particularly a pocket knife or plate-like tool card, comprising a housing with at least one receiving area, and at least two functional components moveable from a storage position within the receiving area, into a working position outside of the receiving area, of which a first functional component is designed as a tool, particularly a pair of scissors, a knife or a utensil, in particular a toothpick,  
20 pincers, cleaning needle, writing pen, wherein a second functional component has a support casing and is equipped with a recordable and readable, nonvolatile memory, as well as an interface; and at least one releasable locking device and a longitudinal guide or a pivot bearing are arranged  
25 between the support bearing of the second functional component, and the housing.

30 2. The pocket tool according to claim 1, wherein the particularly oblong support casing of the second functional component comprises two parallel broad-side walls opposing one another; two parallel narrow-side walls extending substantially vertically between the broad-side walls and opposing one another; as well as two narrow-side walls opposing each other on the face side; and the memory is  
35 arranged within the support casing and the interface on one of the narrow-side walls on the face side.

3. The pocket tool according to claim 1, wherein the second functional component has only a part of the length of the housing.

# Propriedade Intelectual em sua várias dimensões, com destaque a patentes



- O que é patente
- O que é patenteável
- O que não é patenteável
- Como é um documento de patente
- **Como definir o escopo de proteção de uma patente**
- Como é o processo de patenteamento

## CAPÍTULO V

### DA PROTEÇÃO CONFERIDA PELA PATENTE

#### Seção I

##### Dos Direitos

**Art. 41.** A extensão da proteção conferida pela patente será determinada pelo teor das reivindicações, interpretado com base no relatório descritivo e nos desenhos.

Art. 42. A patente confere ao seu titular o direito de impedir terceiro, sem o seu consentimento, de produzir, usar, colocar à venda, vender ou importar com estes propósitos:

I - produto objeto de patente;

II - processo ou produto obtido diretamente por processo patenteado.

§ 1º Ao titular da patente é assegurado ainda o direito de impedir que terceiros contribuam para que outros pratiquem os atos referidos neste artigo.





# Como definir a extensão da cobertura de uma patente - Interpretação

... caracterizado por: **A & B & C**

- Protege: ... & **A & B & C**  
... & A & **B & C** & **D**  
... & **A & B & C**
- Não Protege: ... & (**A & B**) ã **C**

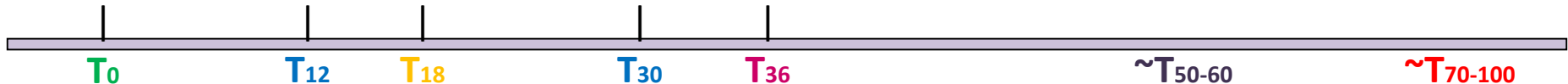
# Propriedade Intelectual em sua várias dimensões, com destaque a patentes



- O que é patente
- O que é patenteável
- O que não é patenteável
- Como é um documento de patente
- Como definir o escopo de proteção
- Como é o processo de patenteamento

# Como é o processo de patenteamento

- Busca prévia (estado da técnica)
- Definição do escopo da invenção, redação do pedido
- Depósito do primeiro pedido (**T<sub>0</sub>**)
- Depósitos internacionais (**T<sub>12</sub>** ou **T<sub>30</sub>**)
- Publicação dos pedidos até então depositados (**T<sub>18</sub>**)
- Pagamento da taxa para exame técnico pelo INPI (**T<sub>20-36</sub>**)
- Exame técnico / Adequação do pedido (**~T<sub>50-60</sub>**)
- Deferimento do pedido
- Expedição da Carta Patente (**~T<sub>70-100</sub>**)
- Nulidade administrativa ou judicial



# Como é o processo de patenteamento

- **Busca prévia (estado da técnica)**
- Definição do escopo da invenção, redação do pedido
- Depósito do primeiro pedido ( $T_0$ )
- Depósitos internacionais ( $T_{12}$  ou  $T_{30}$ )
- Publicação dos pedidos até então depositados ( $T_{18}$ )
- Pagamento da taxa para exame técnico pelo INPI ( $T_{20-36}$ )
- Exame técnico / Adequação do pedido ( $\sim T_{50-60}$ )
- Deferimento do pedido
- Expedição da Carta Patente ( $\sim T_{70-100}$ )
- Nulidade administrativa ou judicial



$T_0$

# Como é o processo de patenteamento

- Busca prévia (estado da técnica)
- **Definição do escopo da invenção, redação do pedido**
- Depósito do primeiro pedido ( $T_0$ )
- Depósitos internacionais ( $T_{12}$  ou  $T_{30}$ )
- Publicação dos pedidos até então depositados ( $T_{18}$ )
- Pagamento da taxa para exame técnico pelo INPI ( $T_{20-36}$ )
- Exame técnico / Adequação do pedido ( $\sim T_{50-60}$ )
- Deferimento do pedido
- Expedição da Carta Patente ( $\sim T_{70-100}$ )
- Nulidade administrativa ou judicial



$T_0$

# Como é o processo de patenteamento

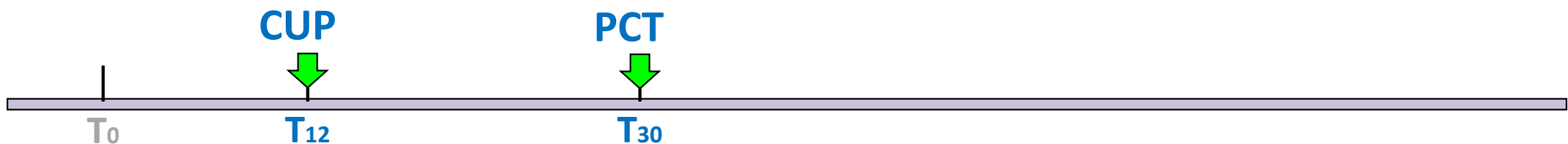
- Busca prévia (estado da técnica)
- Definição do escopo da invenção, redação do pedido
- **Depósito do primeiro pedido ( $T_0$ )**
- Depósitos internacionais ( $T_{12}$  ou  $T_{30}$ )
- Publicação dos pedidos até então depositados ( $T_{18}$ )
- Pagamento da taxa para exame técnico pelo INPI ( $T_{20-36}$ )
- Exame técnico / Adequação do pedido ( $\sim T_{50-60}$ )
- Deferimento do pedido
- Expedição da Carta Patente ( $\sim T_{70-100}$ )
- Nulidade administrativa ou judicial



$T_0$

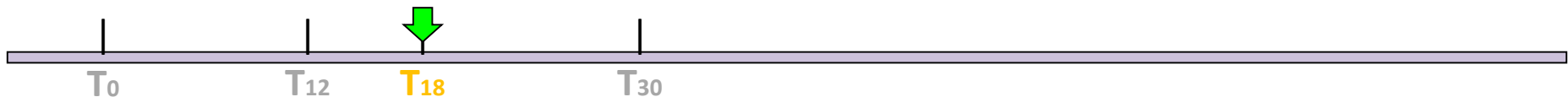
# Como é o processo de patenteamento

- Busca prévia (estado da técnica)
- Definição do escopo da invenção, redação do pedido
- Depósito do primeiro pedido ( $T_0$ )
- **Depósitos internacionais ( $T_{12}$  ou  $T_{30}$ )**
- Publicação dos pedidos até então depositados ( $T_{18}$ )
- Pagamento da taxa para exame técnico pelo INPI ( $T_{20-36}$ )
- Exame técnico / Adequação do pedido ( $\sim T_{50-60}$ )
- Deferimento do pedido
- Expedição da Carta Patente ( $\sim T_{70-100}$ )
- Nulidade administrativa ou judicial



# Como é o processo de patenteamento

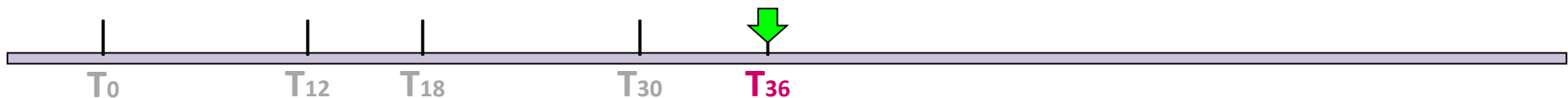
- Busca prévia (estado da técnica)
- Definição do escopo da invenção, redação do pedido
- Depósito do primeiro pedido ( $T_0$ )
- Depósitos internacionais ( $T_{12}$  ou  $T_{30}$ )
- **Publicação dos pedidos até então depositados ( $T_{18}$ )**
- Pagamento da taxa para exame técnico pelo INPI ( $T_{20-36}$ )
- Exame técnico / Adequação do pedido ( $\sim T_{50-60}$ )
- Deferimento do pedido
- Expedição da Carta Patente ( $\sim T_{70-100}$ )
- Nulidade administrativa ou judicial





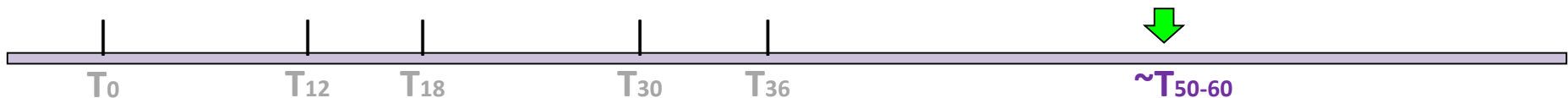
# Como é o processo de patenteamento

- Busca prévia (estado da técnica)
- Definição do escopo da invenção, redação do pedido
- Depósito do primeiro pedido ( $T_0$ )
- Depósitos internacionais ( $T_{12}$  ou  $T_{30}$ )
- Publicação dos pedidos até então depositados ( $T_{18}$ )
- **Pagamento da taxa para exame técnico pelo INPI ( $T_{20-36}$ )**
- Exame técnico / Adequação do pedido ( $\sim T_{50-60}$ )
- Deferimento do pedido
- Expedição da Carta Patente ( $\sim T_{70-100}$ )
- Nulidade administrativa ou judicial



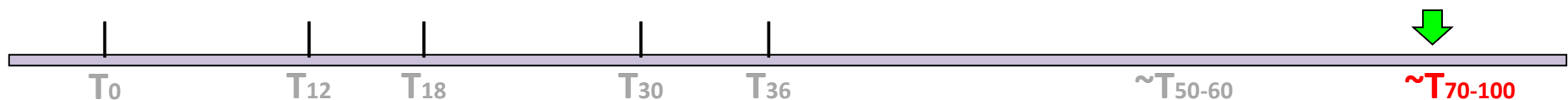
# Como é o processo de patenteamento

- Busca prévia (estado da técnica)
- Definição do escopo da invenção, redação do pedido
- Depósito do primeiro pedido ( $T_0$ )
- Depósitos internacionais ( $T_{12}$  ou  $T_{30}$ )
- Publicação dos pedidos até então depositados ( $T_{18}$ )
- Pagamento da taxa para exame técnico pelo INPI ( $T_{20-36}$ )
- **Exame técnico / Adequação do pedido ( $\sim T_{50-60}$ )**
- Deferimento do pedido
- Expedição da Carta Patente ( $\sim T_{70-100}$ )
- Nulidade administrativa ou judicial



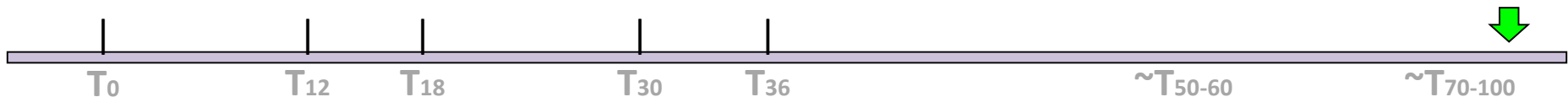
# Como é o processo de patenteamento

- Busca prévia (estado da técnica)
- Definição do escopo da invenção, redação do pedido
- Depósito do primeiro pedido ( $T_0$ )
- Depósitos internacionais ( $T_{12}$  ou  $T_{30}$ )
- Publicação dos pedidos até então depositados ( $T_{18}$ )
- Pagamento da taxa para exame técnico pelo INPI ( $T_{20-36}$ )
- Exame técnico / Adequação do pedido ( $\sim T_{50-60}$ )
- **Deferimento do pedido**
- **Expedição da Carta Patente ( $\sim T_{70-100}$ )**
- Nulidade administrativa ou judicial



# Como é o processo de patenteamento

- Busca prévia (estado da técnica)
- Definição do escopo da invenção, redação do pedido
- Depósito do primeiro pedido ( $T_0$ )
- Depósitos internacionais ( $T_{12}$  ou  $T_{30}$ )
- Publicação dos pedidos até então depositados ( $T_{18}$ )
- Pagamento da taxa para exame técnico pelo INPI ( $T_{20-36}$ )
- Exame técnico / Adequação do pedido ( $\sim T_{50-60}$ )
- Deferimento do pedido
- Expedição da Carta Patente ( $\sim T_{70-100}$ )
- **Nulidade administrativa ou judicial**





# Uso Estratégico de Propriedade Intelectual e Informações Tecnológicas

## Foco no Setor Farmacêutico

- Agenda

- Propriedade Intelectual no contexto farmacêutico, com destaque a patentes

- Uso estratégico de patentes e informações patentárias**

- Ferramentas e técnicas de busca e análise de informações tecnológicas

- Fontes, sistemas de busca e análise de informações com foco na área farmacêutica

- Exemplo de mapeamento de segmento tecnológico



## Uso estratégico de patentes e informações patentárias

- Estudos de patenteabilidade e (in)validade
- Estudos de liberdade de comercialização
- Mapeamento de segmentos tecnológicos
- Invenção estratégica
- Patenteamento estratégico
- Monitoramento de concorrentes
- Identificação e caracterização de parceiros
- Etc.



# Uso estratégico de patentes e informações patentárias

- Estudos de patenteabilidade e (in)validade

- Estudos

**TUDO TORNADO ACESSÍVEL AO PÚBLICO**

- Mapeamento de segmentos tecnológicos

- Invenções

**POR QUALQUER MEIO**

- Patenteabilidade

**EM QUALQUER LUGAR**

- Monitoramento de atividades

- Identificação

**ANTES DA DATA DE PRIORIDADE, COM ALGUMAS EXCEÇÕES**

- Etc.

## Uso estratégico de patentes e informações patentárias

- Estudos de patenteabilidade e (in)validade
- Estudos de liberdade de comercialização

• Mapeam

**TODAS AS PATENTES**

• Invençã

**SOBRE TODOS OS COMPONENTES**

• Patentea

• Monitor

• Identific

**EM TODOS OS TERRITÓRIOS ALVOS**

• Etc.

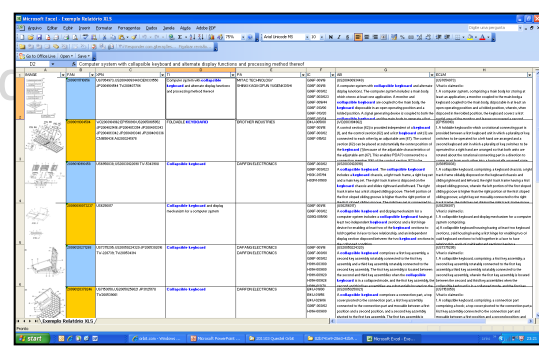
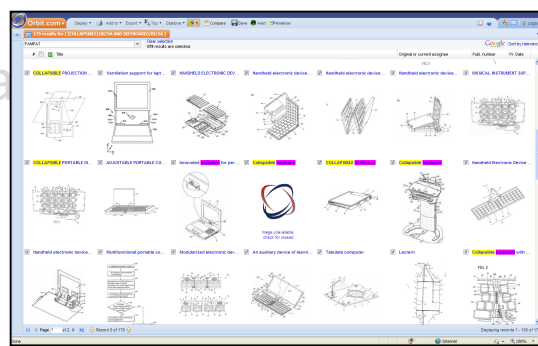
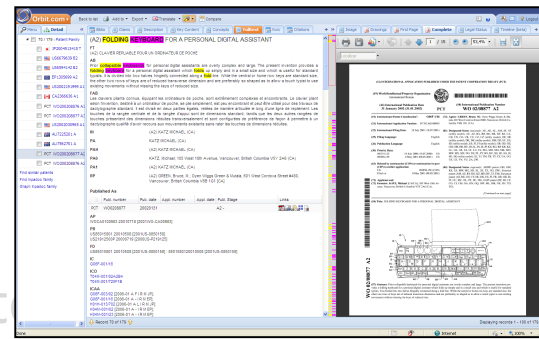
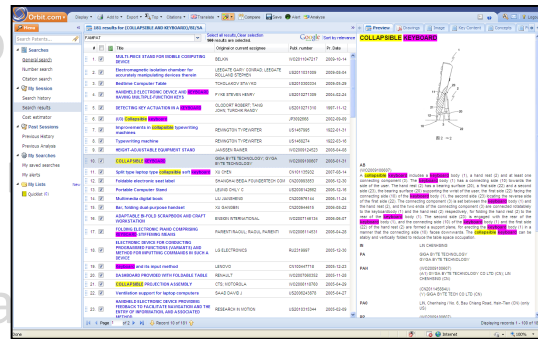


# Uso estratégico de patentes e informações patentárias

- Estudos de patenteabilidade e (in)validade
- Estudos de liberdade de comercialização
- Mapeamento de segmentos tecnológicos

O que?

- Invenção
- Patenteabilidade
- Monitoramento
- Identificação
- Etc.



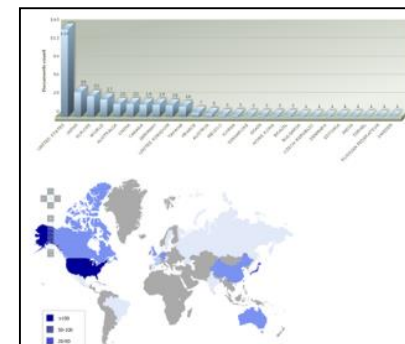
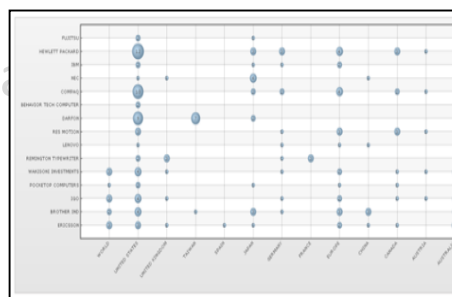
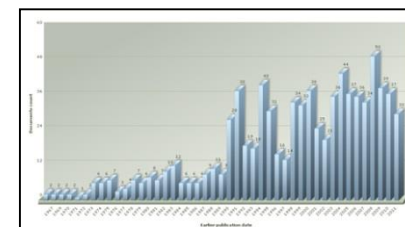
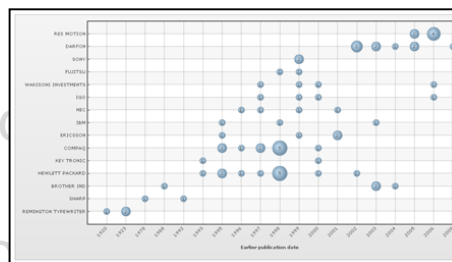
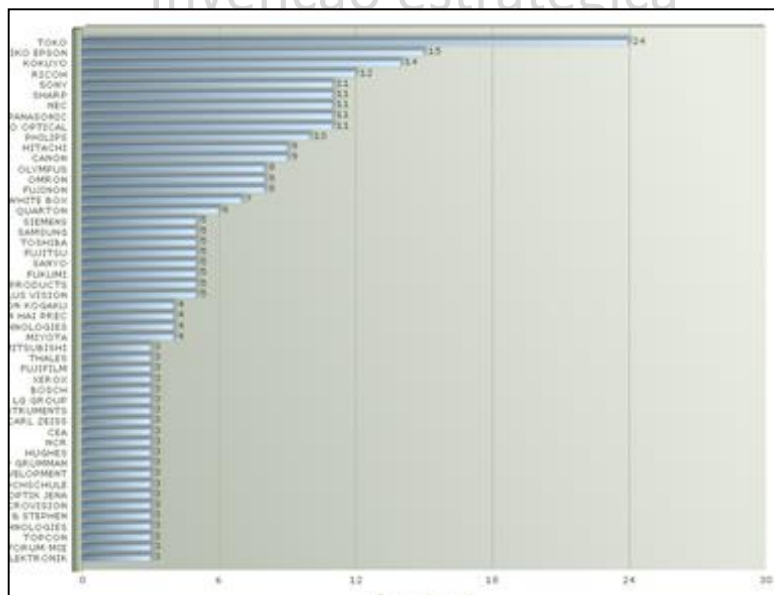
# Uso estratégico de patentes e informações patentárias

- Estudos de patenteabilidade e (in)validade
- Estudos de liberdade de comercialização
- Mapeamento de segmentos tecnológicos
- Invenção estratégica

Quem ?

Quando?

Onde?

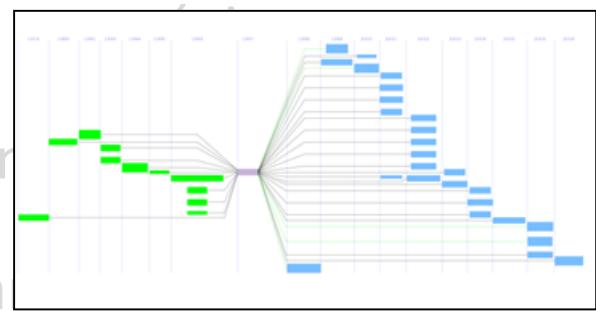
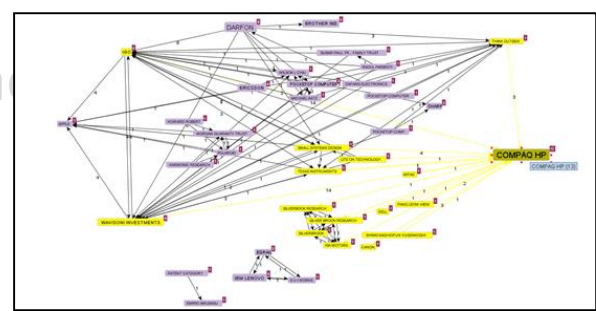


# Uso estratégico de patentes e informações patentárias

- Estudos de patenteabilidade e (in)validade
- Estudos de liberdade de comercialização
- Mapeamento de segmentos tecnológicos

Como?

- Invenção
- Patentear
- Monitorar
- Identificar
- Etc.

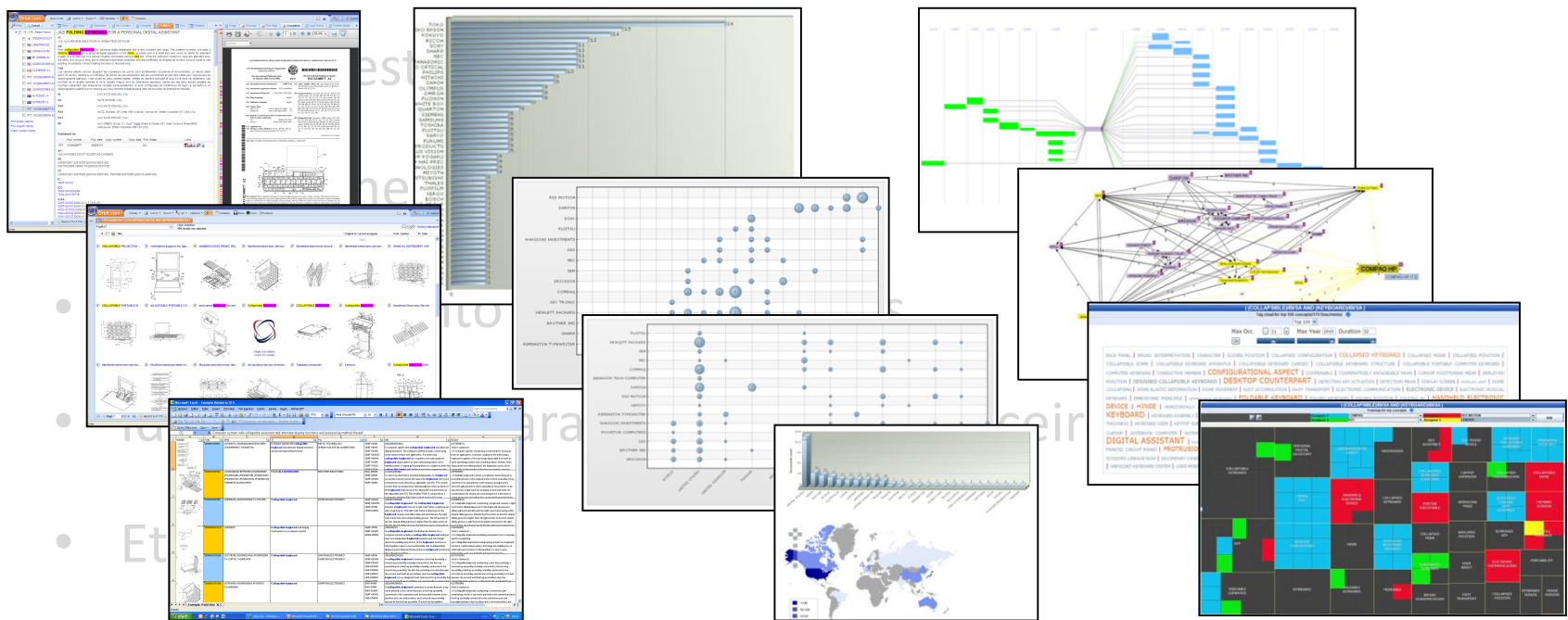



# Uso estratégico de patentes e informações patentárias

- Estudos de patenteabilidade e (in)validade
- Estudos de liberdade de comercialização
- Mapeamento de segmentos tecnológicos

Por quê?

E daí ?



# Uso estratégico de patentes e informações patentárias

- Estudos de patenteabilidade e (in)validade
- Estudos de liberdade de comercialização
- Mapeamento de segmentos tecnológicos

Por quê?

E daí ?

Leis e regulamentações

Acesso a Materiais

Canais de Distribuição

Recursos Financeiros

Etc...

Patentes

Literatura Técnica e Científica

Dados de Mercado

Experts





# Uso estratégico de patentes e informações patentárias

- Estudos de patenteabilidade e (in)validade
- Estudos de liberdade de invenção
- Mapeamento de patentes
- Invenção estratégica

tenha em mente que o “jogo” de patentes é praticado com e contra outros jogadores

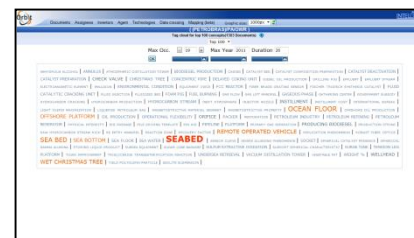
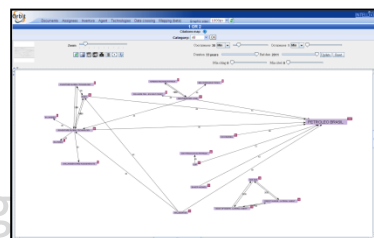
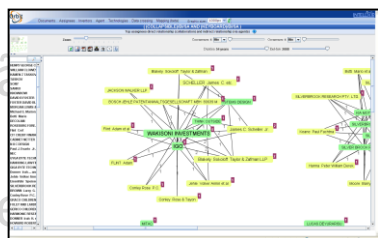
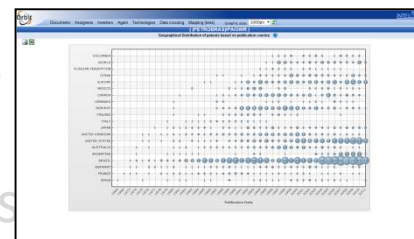
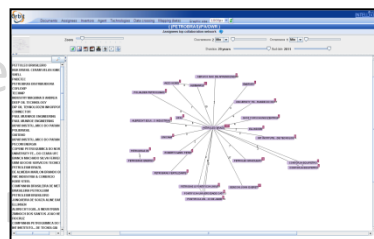
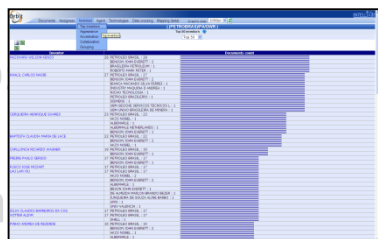
- Patenteamento estratégico
- Monitoramento de patentes
- Identificação de oportunidades
- Etc.

acompanhe e se antecipe a movimentos de concorrentes e entrantes



# Uso estratégico de patentes e informações patentárias

- Estudos de patenteabilidade e (in)validade



Estudo de validade de patentes  
 Mapeamento de redes de patentes  
 Invenções  
 Patentes estratégicas

- Monitoramento de concorrentes
- Identificação e caracterização de parceiros
- Etc.

# Uso estratégico de patentes e informações patentárias

- Estudos de patenteabilidade e (in)validade
- Estudos de liberdade de
- Mapeamento de segmentos
- **Invenção estratégica**
- Patenteamento estratégico
- Monitoramento de concorrentes
- Identificação e caracterização
- Etc.

conheça o que já existe,  
as barreiras de entrada  
e o mercado  
antes de sair inventando

anteveja  
possíveis cenários futuros  
para direcionar esforços



# Exemplo de Caso

Advanced search

Keywords

Title, Abstract

BUILDING BLOCK? 5D BOTTLE CAP?



E.g.:Telecom+ OR phone



Title, Abstract, Claims, Description, C



Classifications

Names

Numbers, dates & country

Legal status

More fields

Collections

Search Show cmd. line Create script Clear

Full Text merged in families (FamPat)

| Search Step | Result(s) | Query                                              | Assistant       | Source | Action                                                                                                                |
|-------------|-----------|----------------------------------------------------|-----------------|--------|-----------------------------------------------------------------------------------------------------------------------|
| 1           | 9         | (BUILDING<br>BLOCK? 5D<br>BOTTLE<br>CAP?)/TI/AB/IW | Advanced search | FAMPAT | <a href="#">Show results</a> <a href="#">Modify</a> <a href="#">Save</a> <a href="#">Alert</a> <a href="#">Delete</a> |

Combine strategies, E.g.: (1 or 2) not 3, 1 and (phone+)

(BUILDING BLOCK? 5D BOTTLE CAP?)/TI/AB/IW

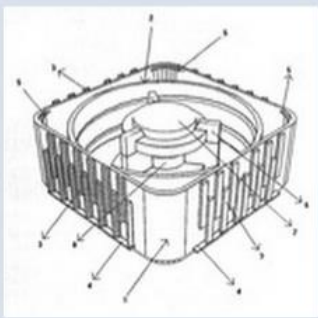
Search

9 results for (BUILDING BLOCK? 5D BOTTLE CAP?)/TI/AB/IW Collection: FAMPAT

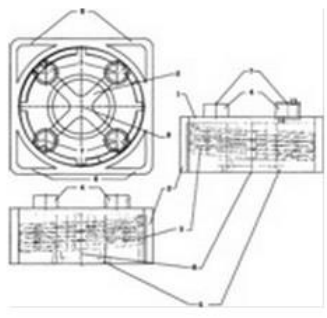
Select [Icons]

Fampat grouping Display [Icons]

# [ ] RS



Magnetic bottle cap building...



Splicing magnetic bottle cap...



Bottle cap building block

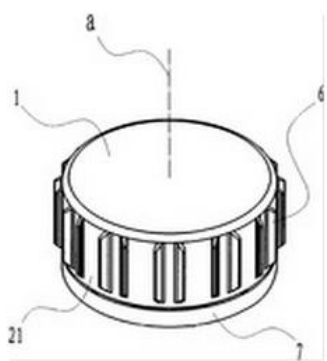


Building system using plasti...

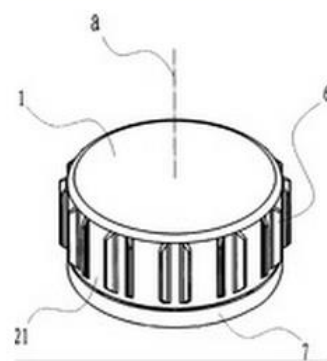


Image unavailable, check for mosaic

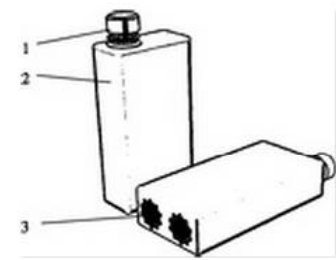
Bottle cap building block



A splicing bottle cap



Bottle cap capable of being ...



Building block bottle

9 results for (BUILDING BLOCK? 5D BOTTLE CAP?)/TI/AB/IW Collection: FAMPAT

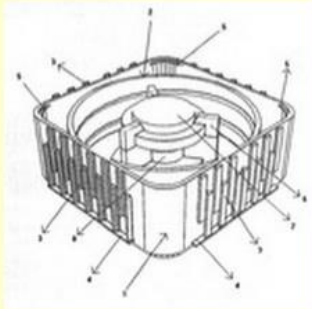
Select: 7

Fampat grouping Display

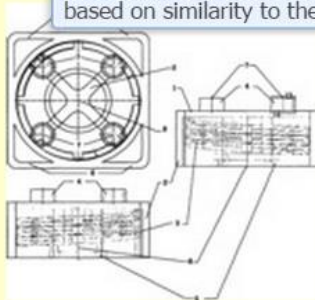
# [x] RS

More like this

Find similar patents, or rank and refine the results set based on similarity to the selected records



Magnetic bottle cap building...



Splicing magnetic bottle cap...



Bottle cap building block

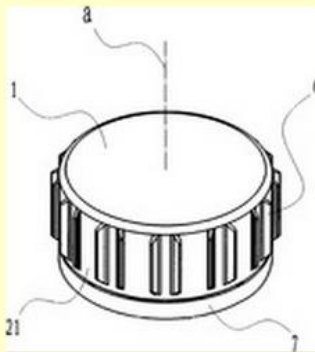


Building system using plasti...

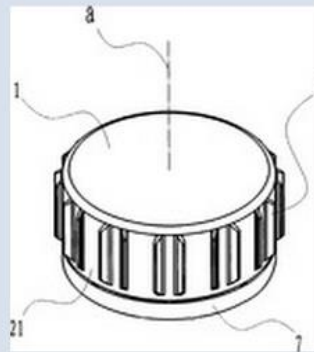


Image unavailable, check for mosaic

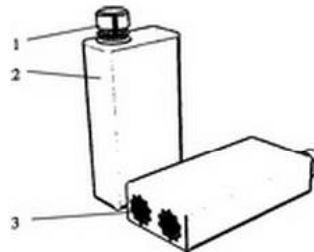
Bottle cap building block



A splicing bottle cap



Bottle cap capable of being ...



Building block bottle

26171 results for Similar patents Collection: FAMPAT



Fampat grouping Display

# RS



Building system using plasti...

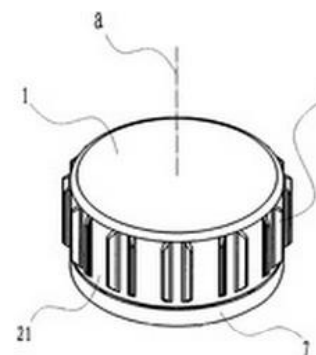


Bottle cap building block

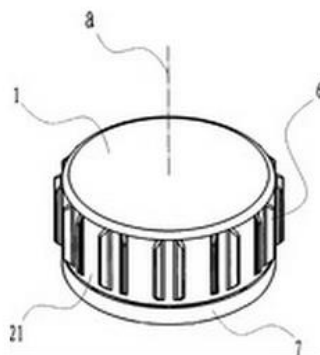


Image unavailable, check for mosaic

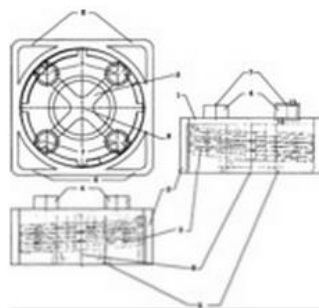
Bottle cap building block



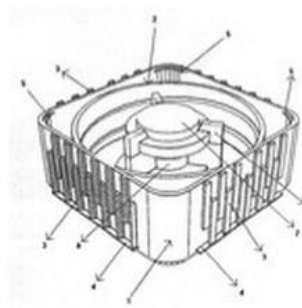
A splicing bottle cap



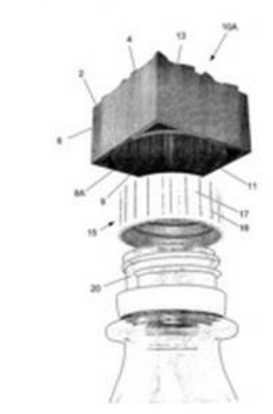
Bottle cap capable of being ...



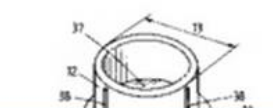
Splicing magnetic bottle cap...



Magnetic bottle cap building...



Modular bottle closure





## 26171 results for Similar patents Collection: FAMPAT



Fampat grouping ▾ Display ▾

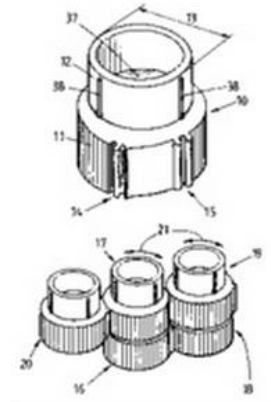
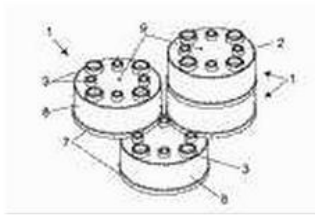
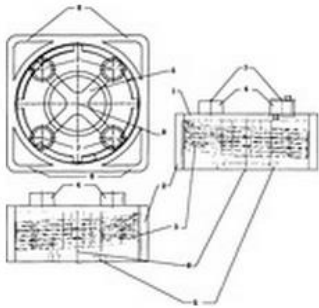
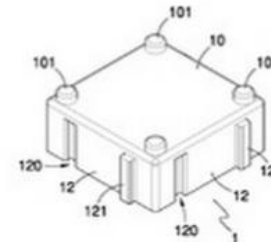
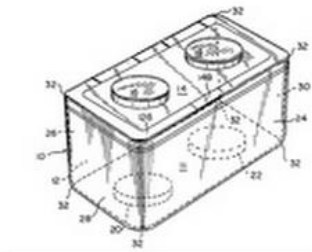
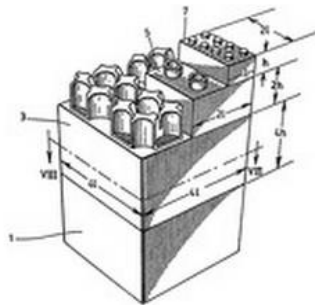
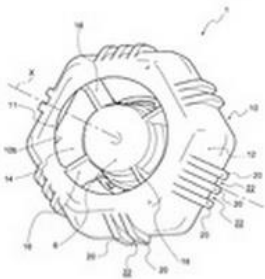
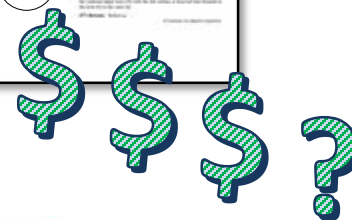
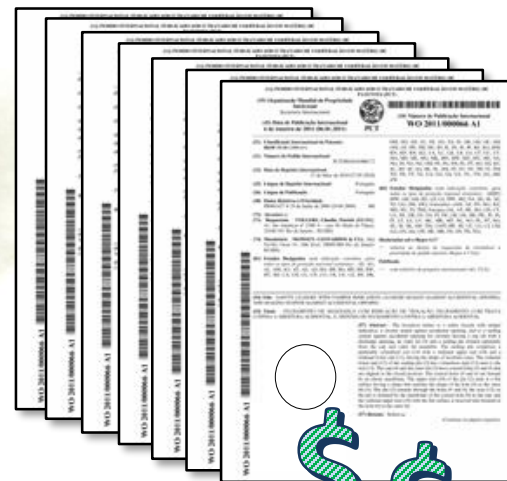
#  RS
 Bottle cap capable of being ...  Splicing magnetic bottle cap ...  Magnetic bottle cap building ...  Modular bottle closure

 Splicing-inserting magnetic ...  Cap re-usable as interlockin...  Toy utilizing used, discarda...  A body for use in a toy set


FIG. 1

 Cap for containers, for exam...  Toy construction assembly  Stackable container for pre...  Bottle caps capable of being...

Fig. 5



**DESIGN MUSEUM**

---

**DESIGNS OF THE YEAR 2014**

---

Pelo  
London Design Museum



**if**

**IF Packaging Design Awards 2014**

Premiado em duas categorias:  
**Categoria 01:** Bebidas  
**Categoria 06:** Formato da embalagem



23º prêmio  
**emb@news**  
 2014

Categoria:  
 Sustentabilidade  
**DESTAQUE!**







# Uso Estratégico de Propriedade Intelectual e Informações Tecnológicas

## Foco no Setor Farmacêutico

- Agenda

- Propriedade Intelectual no contexto farmacêutico, com destaque a patentes
- Uso estratégico de patentes e informações patentárias
- **Ferramentas e técnicas de busca e análise de informações tecnológicas**
- Fontes, sistemas de busca e análise de informações com foco na área farmacêutica
- Exemplo de mapeamento de segmento tecnológico

# Pesquisa e Análise de Patentes

## Ferramentas & Técnicas



- [www.intellogist.com](http://www.intellogist.com)

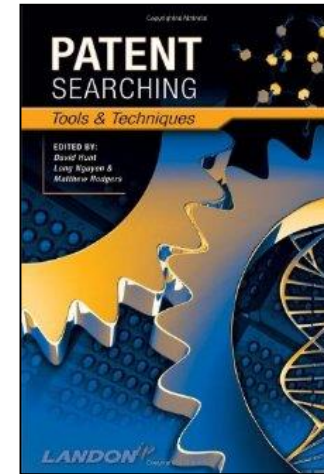
- [www.piug.org](http://www.piug.org)

# Pesquisa e Análise de Patentes

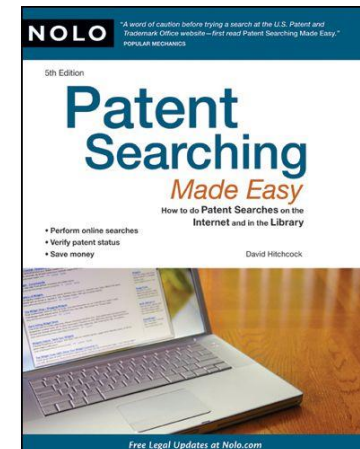
## Ferramentas & Técnicas



- Patent Searching Tools & Techniques



- Patent Searching Made Easy





# Pesquisa e Análise de Patentes

## Ferramentas & Técnicas

### • Palavras Chaves

- Título, Resumo, Relatório Descritivo, Reivindicações

### • Campos Bibliográficos / Outros

- Titular (Assignee), Inventor
- Números de Prioridade, Depósito, Publicação
- Datas, Endereços, Representantes,
- Fórmulas Químicas, Biossequências, etc.

### • Classificações de Patentes

- Internacional, Europeia, Norte Americana, Japonesa

### • Citações

- Referências Citadas, / Citantes
- Pelo Titular / Pelo(s) Examinador(es)

### • Famílias de Patentes

- Cobertura Geográfica
- Invenções Relacionadas

### • Legal Status

- Concessão, Oposição, Abandono, Prolongamento, Etc

# Pesquisa e Análise de Patentes

## Ferramentas & Técnicas

### Palavras Chaves

- Título, Resumo, Relatório Descritivo, Reivindicações

### Campos Bibliográficos / Outros

- Titular (Assignee), Inventor
- Números de Prioridade, Depósito, Publicação
- Datas, Endereços, Representantes,
- Fórmulas Químicas, Biosseqüências, Imagens, etc.

### Classificações de Patentes

- Internacional, Europeia, Norte Americana, Japonesa

### Citações

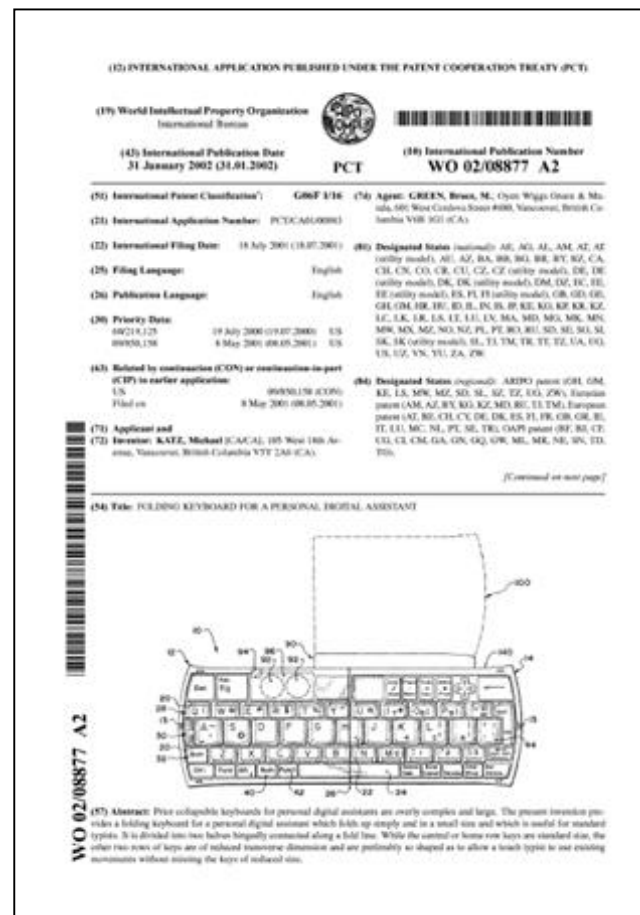
- Referências Citadas, / Citantes
- Pelo Titular / Pelo(s) Examinador(es)

### Famílias de Patentes

- Cobertura Geográfica
- Invenções Relacionadas

### Legal Status

- Concessão, Oposição, Abandono, Prolongamento, Etc



# Pesquisa e Análise de Patentes

## Ferramentas & Técnicas

### • Palavras Chaves

- Título, Resumo, Relatório Descritivo, Reivindicações

### • Outros campos

- Titular (Assignee), Inventor
- Números de Prioridade, Depósito, Publicação
- Datas, Endereços, Representantes,
- Fórmulas Químicas, Biossequências, Imagens, etc.

### ➔ • Classificações de Patentes

- Internacional, Europeia, Norte Americana, Japonesa

### • Citações

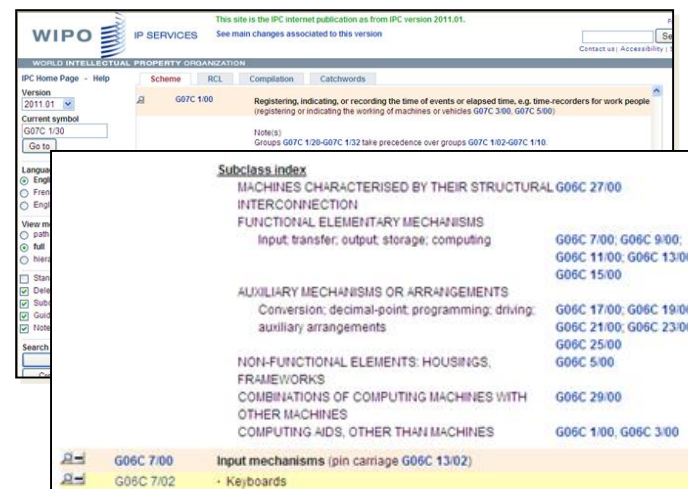
- Referências Citadas, / Citantes
- Pelo Titular / Pelo(s) Examinador(es)

### • Famílias de Patentes

- Cobertura Geográfica
- Invenções Relacionadas

### • Legal Status

- Concessão, Oposição, Abandono, Prolongamento, Etc



WIPO IP SERVICES

WORLD INTELLECTUAL PROPERTY ORGANIZATION

Version: 2011.01  
Current symbol: G07C 1/30

Go to:

Language: Eng, Fre, Esp

View as: full, hier

Display: Def, Sub, Gui, Not

Search:

Subclass index

MACHINES CHARACTERISED BY THEIR STRUCTURAL INTERCONNECTION FUNCTIONAL ELEMENTARY MECHANISMS

|                                                                         |                                                                       |
|-------------------------------------------------------------------------|-----------------------------------------------------------------------|
| Input transfer; output storage; computing                               | G06C 7/00; G06C 9/00; G06C 11/00; G06C 13/00; G06C 15/00              |
| AUXILIARY MECHANISMS OR ARRANGEMENTS                                    |                                                                       |
| Conversion; decimal-point; programming; driving; auxiliary arrangements | G06C 17/00; G06C 19/00; G06C 21/00; G06C 23/00; G06C 25/00; G06C 5/00 |
| NON-FUNCTIONAL ELEMENTS: HOUSINGS, FRAMEWORKS                           |                                                                       |
| COMBINATIONS OF COMPUTING MACHINES WITH OTHER MACHINES                  | G06C 29/00                                                            |
| COMPUTING AIDS, OTHER THAN MACHINES                                     | G06C 1/00; G06C 3/00                                                  |

G06C 7/00 Input mechanisms (pin carriage G06C 13/02)

G06C 7/02 - Keyboards

G06C 7/02: Teclados (para computadores)

# Pesquisa e Análise de Patentes

## Ferramentas & Técnicas

### • Palavras Chaves

- Título, Resumo, Relatório Descritivo, Reivindicações

### • Outros campos

- Titular (Assignee), Inventor
- Números de Prioridade, Depósito, Publicação
- Datas, Endereços, Representantes,
- Fórmulas Químicas, Biossequências, Imagens, etc.

### • Classificações de Patentes

- Internacional, Europeia, Norte Americana, Japonesa

### • Citações

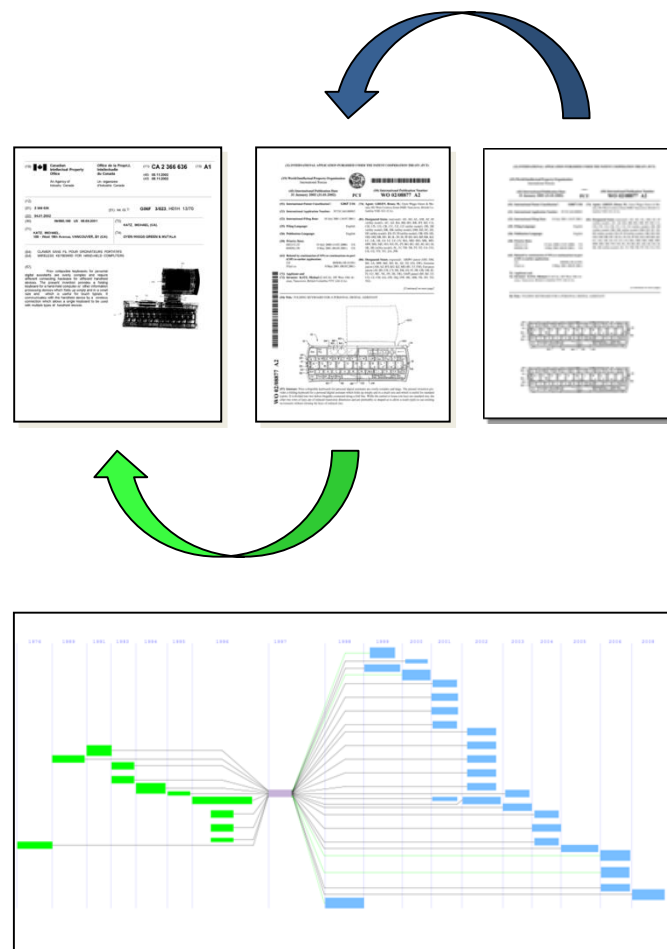
- Referências Citadas, / Citantes
- Pelo Titular / Pelo(s) Examinador(es)

### • Famílias de Patentes

- Cobertura Geográfica
- Invenções Relacionadas

### • Legal Status

- Concessão, Oposição, Abandono, Prolongamento, Etc



# Pesquisa e Análise de Patentes

## Ferramentas & Técnicas

### • Palavras Chaves

- Título, Resumo, Relatório Descritivo, Reivindicações

### • Outros campos

- Titular (Assignee), Inventor
- Números de Prioridade, Depósito, Publicação
- Datas, Endereços, Representantes,
- Fórmulas Químicas, Biossequências, Imagens, etc.

### • Classificações de Patentes

- Internacional, Europeia, Norte Americana, Japonesa

### • Citações

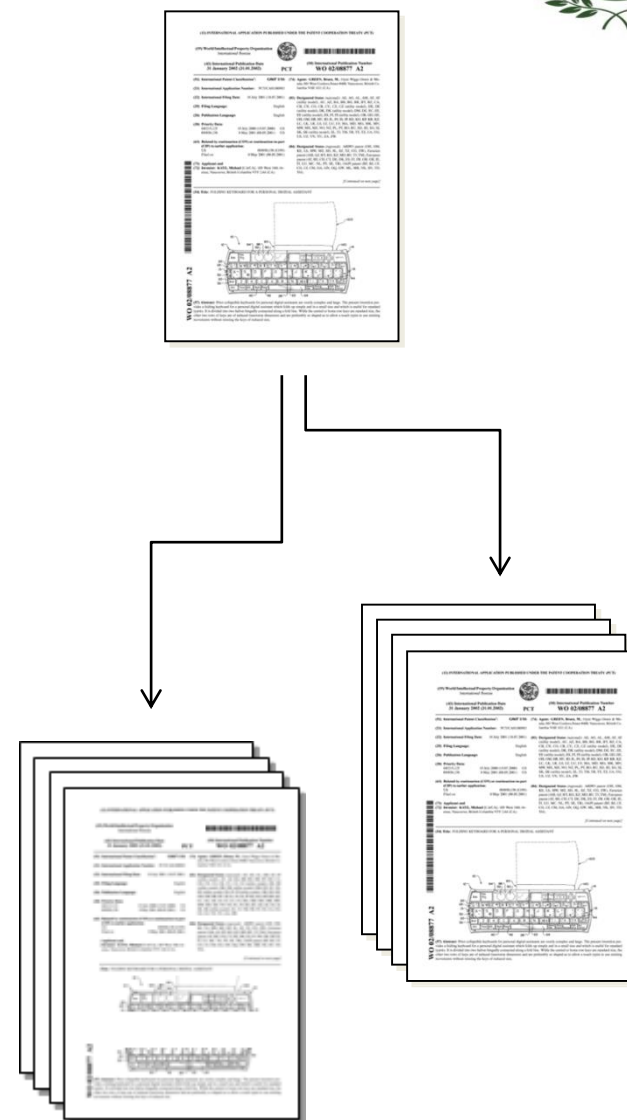
- Referências Citadas, / Citantes
- Pelo Titular / Pelo(s) Examinador(es)

### ➔ • Famílias de Patentes

- Cobertura Geográfica
- Invenções Relacionadas

### • Legal Status

- Concessão, Oposição, Abandono, Prolongamento, Etc





# Pesquisa e Análise de Patentes

## Ferramentas & Técnicas

### • Palavras Chaves

- Título, Resumo, Relatório Descritivo, Reivindicações

### • Outros campos

- Titular (Assignee), Inventor
- Números de Prioridade, Depósito, Publicação
- Datas, Endereços, Representantes,
- Fórmulas Químicas, Biossequências, Imagens, etc.

### • Classificações de Patentes

- Internacional, Europeia, Norte Americana, Japonesa

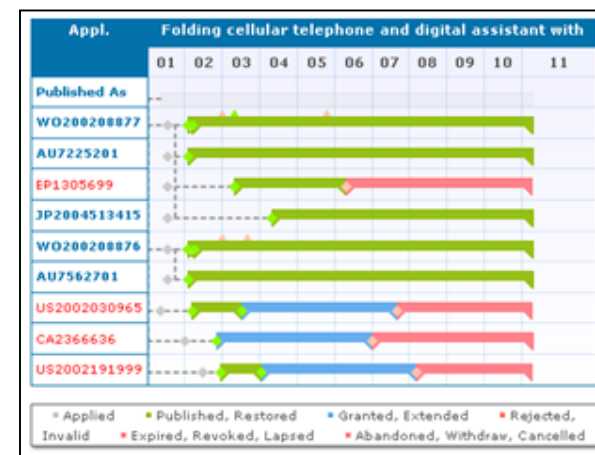
### • Citações

- Referências Citadas, / Citantes
- Pelo Titular / Pelo(s) Examinador(es)

### • Famílias de Patentes

- Cobertura Geográfica
- Invenções Relacionadas

| Legal Status                        |                                                                               |
|-------------------------------------|-------------------------------------------------------------------------------|
| Dead: US2002030965 A1, US6594142 B2 |                                                                               |
| 20010508 US/API [EXM;POS]           | FLING DETAILS<br>US65015801 20010508 [2001US-0850158]                         |
| 20020314 US/A1 [EXM;POS]            | First published patent application<br>US2002030965 A1 20020314 [US2002030965] |
| 20030715 US/B2 [PIF;POS]            | Granted patent as second publication.<br>US6594142 B2 20030715 [US6594142]    |
| 20070904 US/FP-A [NEG;NIF]          | EXPIRED DUE TO FAILURE TO PAY MAINTENANCE<br>FEEEFFECTIVE DATE: 20070715      |

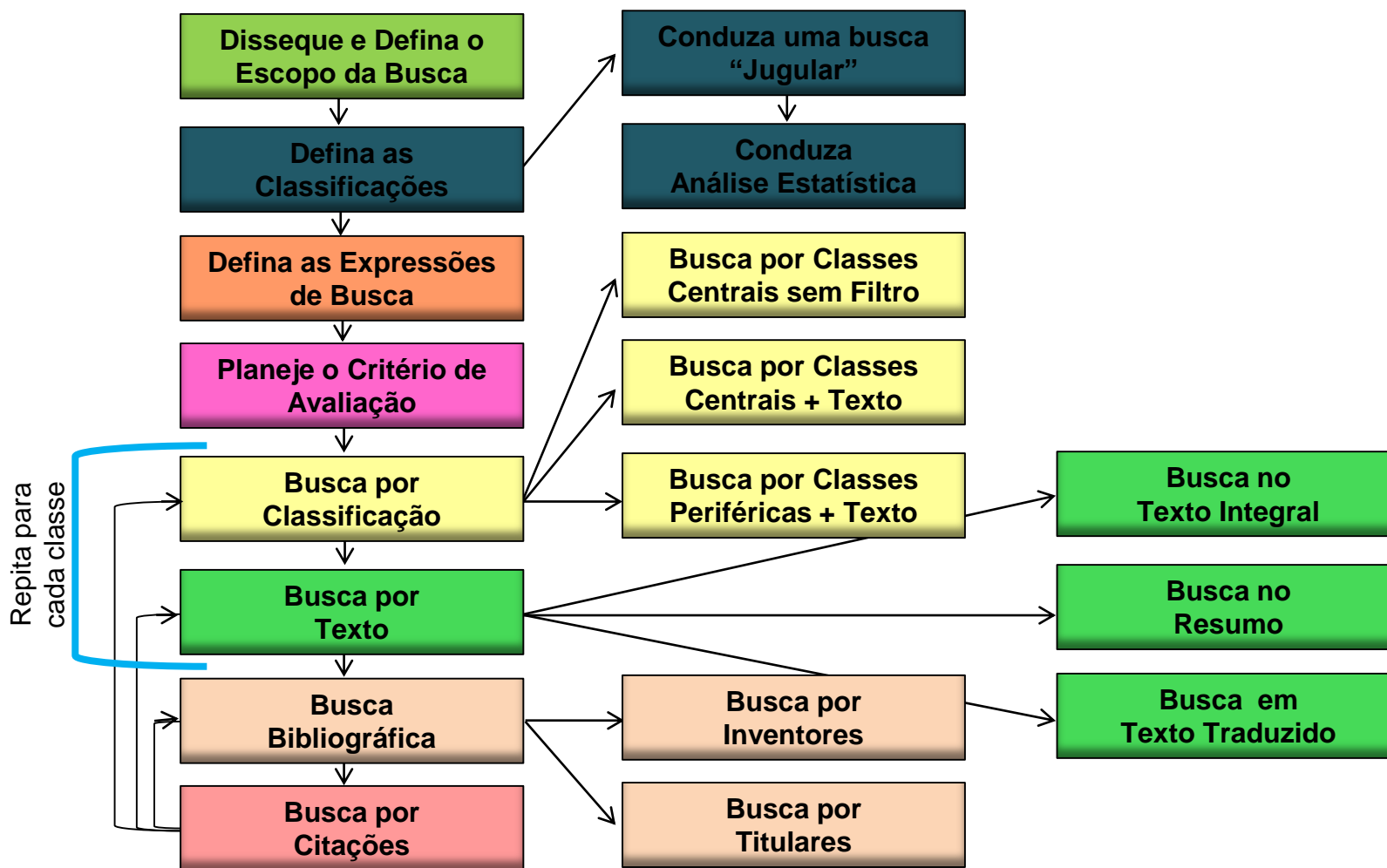


### • Legal Status

- Concessão, Oposição, Abandono, Prolongamento, Etc

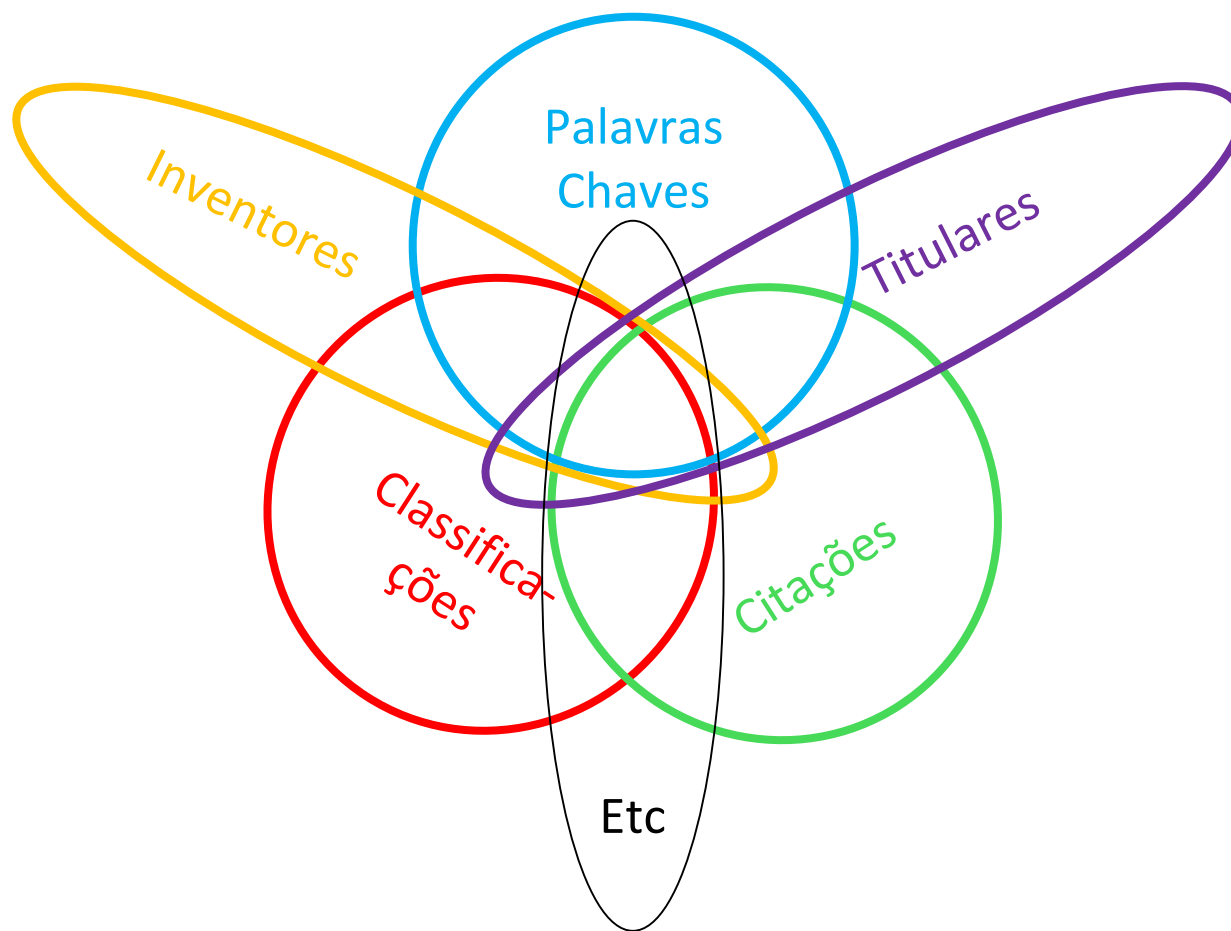
# Pesquisa e Análise de Patentes

## Exemplo de Roteiro de Busca



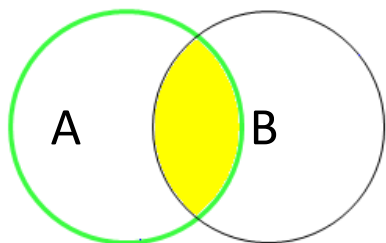
# Pesquisa e Análise de Patentes

## Exemplo de Roteiro de Busca

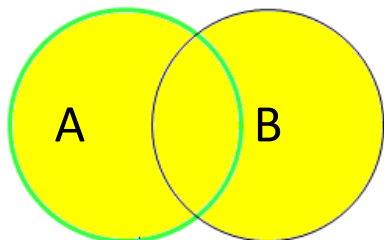


# Buscas de Patentes

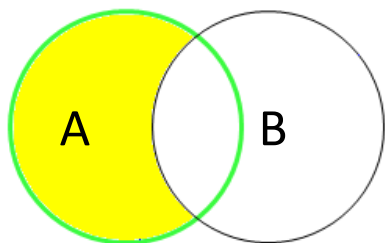
## Operadores Booleanos



A and B (intersecção)



A or B (agrupamento)



A not B (exclusão\*)

\* Lembre-se de usar o NOT para encontrar o complemento. Ou seja, os resultados não contidos no conjunto anterior.



# Buscas de Patentes

## Operadores Booleanos e de Proximidade

|            |                                                                                    |                                    |
|------------|------------------------------------------------------------------------------------|------------------------------------|
| <b>AND</b> | ambos os termos de busca presentes (intersecção)                                   | digital <b>and</b> television      |
| <b>OR</b>  | um ou, opcionalmente, o outro termo de busca presente (soma, grupamento)           | television <b>or</b> tv            |
| <b>NOT</b> | o primeiro termo de busca presente, mas não o segundo (exclusão)                   | <b>1 not 2</b>                     |
| <b>F</b>   | termos de busca no mesmo campo                                                     | digital <b>f</b> (televis+ or tv)  |
| <b>P</b>   | termos de busca no mesmo parágrafo                                                 | digital <b>p</b> (televis+ or tv)  |
| <b>S</b>   | termos de busca na mesma sentença                                                  | digital <b>s</b> (televis+ or tv)  |
| <b>nD</b>  | termos presentes, em qualquer ordem, de zero a n termos de distância (n de 1 a 99) | digital <b>5d</b> (televis+ or tv) |
| <b>D</b>   | termos contíguos, mas em qualquer ordem                                            | digital <b>d</b> (televis+ or tv)  |
| <b>nW</b>  | termos presentes, na ordem digitada, de zero a n termos de distância (n de 1 a 99) | digital <b>5w</b> (televis+ or tv) |
| <b>W</b>   | termos contíguos, exatamente na ordem digitada                                     | digital <b>w</b> (televis+ or tv)  |

# Buscas de Patentes

## Exemplos de Campos de Busca

### Keywords

Title

- Title
- Title, Abstract
- Title, Abstract, Claims
- Title, Abstract, Key Content
- Title, Abstract, Key Content, Claims
- Claims
- Description
- Independent Claims
- Key Content
- Concepts
- Full Text

### Restriction

Limit to the following legal status:

No restriction

- No restriction
- Patent in force
- Opposition
- Licensing
- Term right extended
- Ownership
- Entry into national phase
- Not in force

### Names

Assignee (Original or Current)

- Assignee (Original or Current)
- Current Assignee
- Original Assignee

### Classifications

IPC

- IPC
- ECLA
- ICO
- US (main)
- US (main & x-ref)
- FI
- F-Terms

### Numbers, Dates & Country

Publ. number

- Publ. number
- Appl. number
- Priority number
- Application or Priority number

Abstracts

- Advantages over prior art drawbacks
- Object of invention
- Citations, all
- Citations, non patent References
- Designated States
- FamPat Family Number
- PCT Publication number
- PCT Application Nbr
- Patent Assignee Country
- Patent Assignee US State
- Inventor Country
- Inventor US State
- Representative Country
- US and FR Filing Details
- Other Publication Dates
- First Date of Pub.Appl.
- First Date of Issued Grant
- Patent Date, last pub.
- First Family's Priority Date
- EPO Dutch Class
- Number of Patents in the FamPat Family
- Number of Priorities in the FamPat Family
- USPTO Examiner or US Representative
- Independant claim number (US)
- Number of claims (US)
- Number of drawings (US)
- Number of figures (US)
- US Case ID
- Abstracts



## Buscas de Patentes

### Exemplos de Expressões de Busca

+prazol? or PPI or ((proton pump or hydrogen potassium ATPase or H K ATPase) (w) (inhib+))/bi or 73590-58-6/rn

... (5w) (pellet+ or +granul+ or +spher+))/bi

... and BR/pn



# Uso Estratégico de Propriedade Intelectual e Informações Tecnológicas

## Foco no Setor Farmacêutico

- Agenda

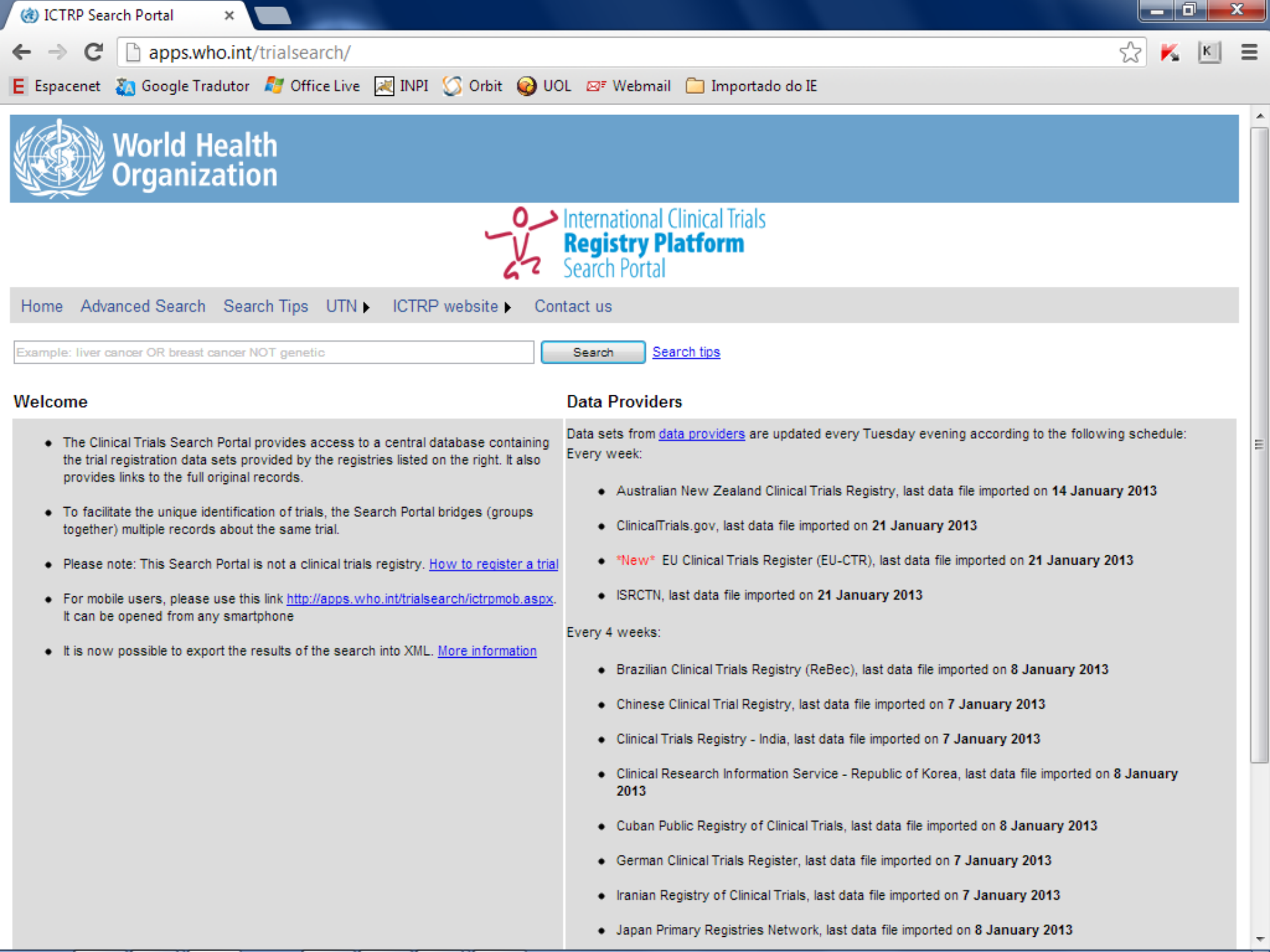
- Propriedade Intelectual no contexto farmacêutico, com destaque a patentes
- Uso estratégico de patentes e informações patentárias
- Ferramentas e técnicas de busca e análise de informações tecnológicas
- **Fontes, sistemas de busca e análise de informações com foco na área farmacêutica**
- Exemplo de mapeamento de segmento tecnológico





## Fontes de Informações Não Patentárias

- Internet aberta  
ex: Google, Google Acadêmico, ClinicalTrials.gov, ICTRP\*, etc.
- Bases de dados indexadas (literatura técnica)  
ex. Caplus\*, Medline, Embase\*, Biosis, DDFU, Pascal, Kosmet, Napralert\*, Scisearch, etc.
- Bases de dados sobre projetos de P&D, licenciamento, notícias, etc.  
Ex. IMS New Product Focus\*, IMS Research\*, Adis R&D Insight, Biotechgate, MedTRACK, RoyaltySource, Chemical Business Newsbase\*  
etc.
- Livros, Teses, Congressos, Conferências, Revisões
- Bulas e literatura de concorrentes
- Especialistas, Etc.

 [Search tips](#)

### Welcome

- The Clinical Trials Search Portal provides access to a central database containing the trial registration data sets provided by the registries listed on the right. It also provides links to the full original records.
- To facilitate the unique identification of trials, the Search Portal bridges (groups together) multiple records about the same trial.
- Please note: This Search Portal is not a clinical trials registry. [How to register a trial](#)
- For mobile users, please use this link <http://apps.who.int/trialsearch/ictrpmob.aspx>. It can be opened from any smartphone
- It is now possible to export the results of the search into XML. [More information](#)

### Data Providers

Data sets from [data providers](#) are updated every Tuesday evening according to the following schedule:  
Every week:

- Australian New Zealand Clinical Trials Registry, last data file imported on **14 January 2013**
- ClinicalTrials.gov, last data file imported on **21 January 2013**
- **\*New\*** EU Clinical Trials Register (EU-CTR), last data file imported on **21 January 2013**
- ISRCTN, last data file imported on **21 January 2013**

Every 4 weeks:

- Brazilian Clinical Trials Registry (ReBec), last data file imported on **8 January 2013**
- Chinese Clinical Trial Registry, last data file imported on **7 January 2013**
- Clinical Trials Registry - India, last data file imported on **7 January 2013**
- Clinical Research Information Service - Republic of Korea, last data file imported on **8 January 2013**
- Cuban Public Registry of Clinical Trials, last data file imported on **8 January 2013**
- German Clinical Trials Register, last data file imported on **7 January 2013**
- Iranian Registry of Clinical Trials, last data file imported on **7 January 2013**
- Japan Primary Registries Network, last data file imported on **8 January 2013**



[Back to Search](#)

[Export results to XML](#)

72 records for 66 trials found for: yellow fever [\(What is this?\)](#)

Show  records per page

1 2 3 4 5 6 7

| Recruitment status | Main ID                               | Public Title                                                                                                                                                                                                                                                   | Date of Registration |
|--------------------|---------------------------------------|----------------------------------------------------------------------------------------------------------------------------------------------------------------------------------------------------------------------------------------------------------------|----------------------|
| Not recruiting     | NCT02231853                           | <a href="#">Phase I/II Trial of Early Infusion of Multivirus Specific T Cells (MVST) to Prevent Post Transplant Viral Infections</a>                                                                                                                           | 03/09/2014           |
| Authorised         | EUCTR2014-001118-24-BE <sup>(+)</sup> | <a href="#">Evaluation of the immunogenicity and safety of GlaxoSmithKline (GSK) Biologicals' Quadrivalent Influenza Vaccine Influxplit™ Tetra (Fluarix™ Tetra) (GSK2321138A) when co-administered with Pneumovax™ 23 in adults 50 years of age and older.</a> | 18/07/2014           |
| Recruiting         | NCT02103023                           | <a href="#">Intradermal Influenza Vaccine in the Young</a>                                                                                                                                                                                                     | 28/03/2014           |
| Not recruiting     | NCT02072174                           | <a href="#">Clinical Trial of Efficacy of Anaferon for Children® in the Treatment of Influenza and Acute Respiratory Viral Infections in Children</a>                                                                                                          | 14/02/2014           |
| Recruiting         | NCT02013934                           | <a href="#">Probiotics in Prevention of Common Cold</a>                                                                                                                                                                                                        | 06/12/2013           |
| Not recruiting     | NCT02007356                           | <a href="#">A Study to Assess Safety and Feasibility of Direct Infusions of Donor-derived Virus-specific T-cells in Recipients of Hematopoietic Stem Cell Transplantation With Post-transplant Viral Infections Using the Cytokine Capture System®</a>         | 26/11/2013           |
| Not Recruiting     | DRKS00005310                          | <a href="#">The role of monocytes at the infect defense after stem cell transplantation in children and young adults.</a>                                                                                                                                      | 23/09/2013           |
| Recruiting         | NCT01943305                           | <a href="#">The Role of Pre-existing Cross-reactive Antibodies in Determining the Efficacy of Vaccination in Humans</a>                                                                                                                                        | 03/09/2013           |
| Not Recruiting     | CTRI/2013/08/003919                   | <a href="#">TO EVALUATE EFFICACY AND SAFETY OF DNT -53 IN PATIENTS WITH LOW PLATELET COUNT.</a>                                                                                                                                                                | 23-08-2013           |
| Not Recruiting     | NTR4102                               | <a href="#">Prevalence, burden, and shedding patterns of respiratory viral infections on the ICU</a>                                                                                                                                                           | 20/08/2013           |

1 2 3 4 5 6 7

## CAplus<sup>SM</sup>/HCplus/ZCAplus (Chemical Abstracts Plus)

|                                                 |                                                                                                                                                                                                                                                                                                                                                                                                                                                                                                                                                                                                                                                                                                                                                                                                                                                                                                                                                                                                                                                                                                                                                                                                                                                                                                                                                                                  |                                                 |                                     |                                                     |                                     |                                                     |                                     |                                  |                                     |                       |                                     |                                      |                                     |                                   |                                     |            |                                     |                                                    |                                     |
|-------------------------------------------------|----------------------------------------------------------------------------------------------------------------------------------------------------------------------------------------------------------------------------------------------------------------------------------------------------------------------------------------------------------------------------------------------------------------------------------------------------------------------------------------------------------------------------------------------------------------------------------------------------------------------------------------------------------------------------------------------------------------------------------------------------------------------------------------------------------------------------------------------------------------------------------------------------------------------------------------------------------------------------------------------------------------------------------------------------------------------------------------------------------------------------------------------------------------------------------------------------------------------------------------------------------------------------------------------------------------------------------------------------------------------------------|-------------------------------------------------|-------------------------------------|-----------------------------------------------------|-------------------------------------|-----------------------------------------------------|-------------------------------------|----------------------------------|-------------------------------------|-----------------------|-------------------------------------|--------------------------------------|-------------------------------------|-----------------------------------|-------------------------------------|------------|-------------------------------------|----------------------------------------------------|-------------------------------------|
| <b>Subject Coverage</b>                         | <ul style="list-style-type: none"> <li>Analytical chemistry</li> <li>Applied chemistry</li> <li>Biochemistry</li> <li>Chemical engineering</li> <li>Macromolecular chemistry</li> <li>Organic chemistry</li> </ul>                                                                                                                                                                                                                                                                                                                                                                                                                                                                                                                                                                                                                                                                                                                                                                                                                                                                                                                                                                                                                                                                                                                                                               |                                                 |                                     |                                                     |                                     |                                                     |                                     |                                  |                                     |                       |                                     |                                      |                                     |                                   |                                     |            |                                     |                                                    |                                     |
| <b>File Type</b>                                | Bibliographic                                                                                                                                                                                                                                                                                                                                                                                                                                                                                                                                                                                                                                                                                                                                                                                                                                                                                                                                                                                                                                                                                                                                                                                                                                                                                                                                                                    |                                                 |                                     |                                                     |                                     |                                                     |                                     |                                  |                                     |                       |                                     |                                      |                                     |                                   |                                     |            |                                     |                                                    |                                     |
| <b>Features</b>                                 | <p>Thesauri      Classification Code (/CC), Company Name (/CO), Controlled Term (/CT), Cooperative Patent Classification (CPC), European Patent Classification (/ECLA), F-Term (/FTERM), ICO (in-computer-only) Classification (/ICO), International Patent Classifications (/IPC), National Patent Classifications Current (/NCL), National Patent Classifications Issue (/INCL), and Role (/RL)</p> <p><a href="#">Alerts (SDIs)</a>      Daily (Monday-Friday), weekly (default), biweekly</p> <table border="0"> <tr> <td><a href="#">CAS Registry Number Identifiers</a></td> <td><input checked="" type="checkbox"/></td> <td>Page Images</td> <td><input checked="" type="checkbox"/></td> <td><a href="#">STN<sup>®</sup> AnaVist<sup>™</sup></a></td> <td><input checked="" type="checkbox"/></td> </tr> <tr> <td><a href="#">Keep &amp; Share</a></td> <td><input checked="" type="checkbox"/></td> <td><a href="#">SLART</a></td> <td><input checked="" type="checkbox"/></td> <td><a href="#">STN Easy<sup>®</sup></a></td> <td><input checked="" type="checkbox"/></td> </tr> <tr> <td><a href="#">Learning Database</a></td> <td><input checked="" type="checkbox"/></td> <td>Structures</td> <td><input checked="" type="checkbox"/></td> <td><a href="#">STN<sup>®</sup> Viewer<sup>™</sup></a></td> <td><input checked="" type="checkbox"/></td> </tr> </table> | <a href="#">CAS Registry Number Identifiers</a> | <input checked="" type="checkbox"/> | Page Images                                         | <input checked="" type="checkbox"/> | <a href="#">STN<sup>®</sup> AnaVist<sup>™</sup></a> | <input checked="" type="checkbox"/> | <a href="#">Keep &amp; Share</a> | <input checked="" type="checkbox"/> | <a href="#">SLART</a> | <input checked="" type="checkbox"/> | <a href="#">STN Easy<sup>®</sup></a> | <input checked="" type="checkbox"/> | <a href="#">Learning Database</a> | <input checked="" type="checkbox"/> | Structures | <input checked="" type="checkbox"/> | <a href="#">STN<sup>®</sup> Viewer<sup>™</sup></a> | <input checked="" type="checkbox"/> |
| <a href="#">CAS Registry Number Identifiers</a> | <input checked="" type="checkbox"/>                                                                                                                                                                                                                                                                                                                                                                                                                                                                                                                                                                                                                                                                                                                                                                                                                                                                                                                                                                                                                                                                                                                                                                                                                                                                                                                                              | Page Images                                     | <input checked="" type="checkbox"/> | <a href="#">STN<sup>®</sup> AnaVist<sup>™</sup></a> | <input checked="" type="checkbox"/> |                                                     |                                     |                                  |                                     |                       |                                     |                                      |                                     |                                   |                                     |            |                                     |                                                    |                                     |
| <a href="#">Keep &amp; Share</a>                | <input checked="" type="checkbox"/>                                                                                                                                                                                                                                                                                                                                                                                                                                                                                                                                                                                                                                                                                                                                                                                                                                                                                                                                                                                                                                                                                                                                                                                                                                                                                                                                              | <a href="#">SLART</a>                           | <input checked="" type="checkbox"/> | <a href="#">STN Easy<sup>®</sup></a>                | <input checked="" type="checkbox"/> |                                                     |                                     |                                  |                                     |                       |                                     |                                      |                                     |                                   |                                     |            |                                     |                                                    |                                     |
| <a href="#">Learning Database</a>               | <input checked="" type="checkbox"/>                                                                                                                                                                                                                                                                                                                                                                                                                                                                                                                                                                                                                                                                                                                                                                                                                                                                                                                                                                                                                                                                                                                                                                                                                                                                                                                                              | Structures                                      | <input checked="" type="checkbox"/> | <a href="#">STN<sup>®</sup> Viewer<sup>™</sup></a>  | <input checked="" type="checkbox"/> |                                                     |                                     |                                  |                                     |                       |                                     |                                      |                                     |                                   |                                     |            |                                     |                                                    |                                     |
| <b>Record Content</b>                           | <ul style="list-style-type: none"> <li>Bibliographic information and available abstracts</li> <li>Cited references for journals, conference proceedings, and basic patents from the US, EPO, WIPO, and German patent offices added to CAS databases since 1997</li> <li>Patent examiner citations from British and French patents (2003-present), Canadian patents (2005-present), Japanese patents (2011-present), as well as nearly 300,000 patent records from 1982-2008</li> <li>Citing references</li> <li>Legal status information for U.S. patents since 1980</li> <li>Patent classifications: IPC, CPC, ECLA, ICO, NCL and FTERM</li> </ul>                                                                                                                                                                                                                                                                                                                                                                                                                                                                                                                                                                                                                                                                                                                              |                                                 |                                     |                                                     |                                     |                                                     |                                     |                                  |                                     |                       |                                     |                                      |                                     |                                   |                                     |            |                                     |                                                    |                                     |
| <b>File Size</b>                                | More than 40.1 million records (9/2014)                                                                                                                                                                                                                                                                                                                                                                                                                                                                                                                                                                                                                                                                                                                                                                                                                                                                                                                                                                                                                                                                                                                                                                                                                                                                                                                                          |                                                 |                                     |                                                     |                                     |                                                     |                                     |                                  |                                     |                       |                                     |                                      |                                     |                                   |                                     |            |                                     |                                                    |                                     |
| <b>Coverage</b>                                 | 1907-present plus more than 180,000 pre-1907 records                                                                                                                                                                                                                                                                                                                                                                                                                                                                                                                                                                                                                                                                                                                                                                                                                                                                                                                                                                                                                                                                                                                                                                                                                                                                                                                             |                                                 |                                     |                                                     |                                     |                                                     |                                     |                                  |                                     |                       |                                     |                                      |                                     |                                   |                                     |            |                                     |                                                    |                                     |
| <b>Updates</b>                                  | Daily updates (more than 5000 records)                                                                                                                                                                                                                                                                                                                                                                                                                                                                                                                                                                                                                                                                                                                                                                                                                                                                                                                                                                                                                                                                                                                                                                                                                                                                                                                                           |                                                 |                                     |                                                     |                                     |                                                     |                                     |                                  |                                     |                       |                                     |                                      |                                     |                                   |                                     |            |                                     |                                                    |                                     |
| <b>Language</b>                                 | English                                                                                                                                                                                                                                                                                                                                                                                                                                                                                                                                                                                                                                                                                                                                                                                                                                                                                                                                                                                                                                                                                                                                                                                                                                                                                                                                                                          |                                                 |                                     |                                                     |                                     |                                                     |                                     |                                  |                                     |                       |                                     |                                      |                                     |                                   |                                     |            |                                     |                                                    |                                     |
| <b>Database Producer</b>                        | Chemical Abstracts Service<br>2540 Olentangy River Road<br>P.O. Box 3012<br>Columbus, Ohio 43210-0012 USA                                                                                                                                                                                                                                                                                                                                                                                                                                                                                                                                                                                                                                                                                                                                                                                                                                                                                                                                                                                                                                                                                                                                                                                                                                                                        |                                                 |                                     |                                                     |                                     |                                                     |                                     |                                  |                                     |                       |                                     |                                      |                                     |                                   |                                     |            |                                     |                                                    |                                     |

---

|                          |                                                                                                                                                                                                                                                                                                                                                                                                                                                                                                                                                                                                                                                                                                                                                                          |                                                                                                                                                                                                                                                       |                                                                                                                                                                                                                                                                                                             |
|--------------------------|--------------------------------------------------------------------------------------------------------------------------------------------------------------------------------------------------------------------------------------------------------------------------------------------------------------------------------------------------------------------------------------------------------------------------------------------------------------------------------------------------------------------------------------------------------------------------------------------------------------------------------------------------------------------------------------------------------------------------------------------------------------------------|-------------------------------------------------------------------------------------------------------------------------------------------------------------------------------------------------------------------------------------------------------|-------------------------------------------------------------------------------------------------------------------------------------------------------------------------------------------------------------------------------------------------------------------------------------------------------------|
| <b>Sources</b>           | <p>Journals: Over 10,000 journals are monitored. All articles, including biographical items, book reviews, editorials, errata, letters to the editor, news announcements, product reviews, meeting abstracts, and miscellaneous items, from nearly 1500 key chemical journals covered since 1994. Bibliographic information and available abstracts for the articles from key journals are added within 1 week of journal receipt. New bibliographic records are added daily.</p> <ul style="list-style-type: none"> <li>• Patents</li> <li>• Conference proceedings</li> <li>• Electronic-only journals</li> <li>• Books</li> <li>• Dissertations</li> <li>• Reviews</li> <li>• Technical disclosures</li> <li>• Web pre-prints</li> <li>• Meeting abstracts</li> </ul> |                                                                                                                                                                                                                                                       |                                                                                                                                                                                                                                                                                                             |
| <b>User Aids</b>         | <ul style="list-style-type: none"> <li>• Training materials are available on the CAS website at <a href="http://www.cas.org">www.cas.org</a></li> <li>• STNGUIDE</li> </ul>                                                                                                                                                                                                                                                                                                                                                                                                                                                                                                                                                                                              | <ul style="list-style-type: none"> <li>• Online Helps (HELP DIRECTORY lists all help messages available)</li> </ul>                                                                                                                                   |                                                                                                                                                                                                                                                                                                             |
| <b>Clusters</b>          | <ul style="list-style-type: none"> <li>• 2ANAVIST</li> <li>• AEROTECH</li> <li>• AGRICULTURE</li> <li>• ALLBIB</li> <li>• AUTHORS</li> <li>• BIOSCIENCE</li> <li>• CASLINK</li> <li>• CASRNS</li> <li>• CHEMENG</li> <li>• CHEMISTRY</li> </ul>                                                                                                                                                                                                                                                                                                                                                                                                                                                                                                                          | <ul style="list-style-type: none"> <li>• CORPSOURCE</li> <li>• ENGINEERING</li> <li>• ENVIRONMENT</li> <li>• FOOD</li> <li>• FORMULATIONS</li> <li>• FUELS</li> <li>• GEOSCIENCE</li> <li>• GOVREGS</li> <li>• HEALTH</li> <li>• MATERIALS</li> </ul> | <ul style="list-style-type: none"> <li>• MEDICINE</li> <li>• METALS</li> <li>• PATENTS</li> <li>• PETROLEUM</li> <li>• PHARMACOLOGY</li> <li>• PHYSICS</li> <li>• POLYMERS</li> <li>• PV</li> <li>• SAFETY</li> <li>• TOXICOLOGY</li> </ul> <p><a href="#">STN Database Clusters information</a> (PDF).</p> |
| <b>Related Databases</b> | <ul style="list-style-type: none"> <li>• CA</li> <li>• LCA</li> </ul>                                                                                                                                                                                                                                                                                                                                                                                                                                                                                                                                                                                                                                                                                                    |                                                                                                                                                                                                                                                       |                                                                                                                                                                                                                                                                                                             |
| <b>Pricing</b>           | Enter HELP COST at an arrow prompt.                                                                                                                                                                                                                                                                                                                                                                                                                                                                                                                                                                                                                                                                                                                                      |                                                                                                                                                                                                                                                       |                                                                                                                                                                                                                                                                                                             |

---



## Sample Records

### DISPLAY ALL (Journal)

ANSWER 1 OF 1 CAPLUS COPYRIGHT 2013 ACS on STN

AN 2000:138202 CAPLUS [Full-text](#)

DN 132:221385

ED Entered STN: 01 Mar 2000

TI Production process for recombinant human angiostatin in *Pichia pastoris*

AU Lin, J.; Panigraphy, D.; Trinh, L. B.; Folkman, J.; Shiloach, J.

CS Department of Surgery, Children's Hospital and Harvard Medical School,  
Boston, MA, 02115, USA

SO Journal of Industrial Microbiology & Biotechnology (2000), 24(1), 31-35

CODEN: JIMBFL; ISSN: 1367-5435

DOI 10.1038/sj.jim.2900766

PB Nature Publishing Group

DT Journal

LA English

CC 16-2 (Fermentation and Bioindustrial Chemistry)

AB A pilot-scale production method of recombinant human angiostatin, a 38-kD fragment of plasminogen which has been reported to have antiangiogenic activity, has been successfully established by expressing the protein in the methylotrophic yeast *Pichia pastoris*. The secreted protein inhibited cultured endothelial cell proliferation in vitro and Lewis lung carcinoma growth in mice. The fermentation process was carried out using an online methanol controller, administering methanol to the growing culture and keeping its concentration under 2 g L<sup>-1</sup>. The fermentation lasted 90 h, of which 70 h were growth on methanol. During growth on methanol the culture volume increased 64%, from 7 L to 11.5 L, producing 200 mg angiostatin and 5 kg of biomass.

ST recombinant human angiostatin fermn *Pichia*

IT Fermentation

*Komagataella pastoris*

(production process for recombinant human angiostatin in *Pichia pastoris*)

IT 86090-08-6P, Angiostatin

RL: BMF (Bioindustrial manufacture); BIOL (Biological study); PREP

(Preparation)

(production process for recombinant human angiostatin in *Pichia pastoris*)

IT 67-56-1, Methanol, biological studies

RL: BSU (Biological study, unclassified); BIOL (Biological study)

(production process for recombinant human angiostatin in *Pichia pastoris*)

OSC.G 10 THERE ARE 10 CAPLUS RECORDS THAT CITE THIS RECORD (10 CITINGS)

UPOS.G Date last citing reference entered STN: 27 Feb 2012

OS.G CAPLUS 2012:181723; 2010:1328434; 2010:548903; 2009:1288101;  
2009:637424; 2007:75901; 2005:702147; 2005:3368; 2003:236743;  
2001:230866

RE.CNT 18 THERE ARE 18 CITED REFERENCES AVAILABLE FOR THIS RECORD

RE CITED REFERENCES

(1) Brierley, R; Ann NY Acad Sci 1990, V589, P350 CAPLUS

(2) Brierley, R; WO 9003431 International Patent (PCT) Application 1989 CAPLUS

(3) Chen, Y; Proc Biochem 1997, V32, P107

(4) Folkman, J; Proc Natl Acad Sci 1979, V76, P5217 MEDLINE

## NAPRALERT

|                          |                                                                                                                                                                                                                                                                                                                                                                                                                                                                                                                                                                                                                                                                                                                          |                                                           |                                                                           |
|--------------------------|--------------------------------------------------------------------------------------------------------------------------------------------------------------------------------------------------------------------------------------------------------------------------------------------------------------------------------------------------------------------------------------------------------------------------------------------------------------------------------------------------------------------------------------------------------------------------------------------------------------------------------------------------------------------------------------------------------------------------|-----------------------------------------------------------|---------------------------------------------------------------------------|
| <b>Subject Coverage</b>  | Natural product information including pharmacology, biological activity, taxonomic distribution, ethnomedicine, and chemistry of plant, microbial, and animal (including marine) extracts                                                                                                                                                                                                                                                                                                                                                                                                                                                                                                                                |                                                           |                                                                           |
| <b>File Type</b>         | Bibliographic                                                                                                                                                                                                                                                                                                                                                                                                                                                                                                                                                                                                                                                                                                            |                                                           |                                                                           |
| <b>Features</b>          | <a href="#">CAS Registry Number Identifiers</a> <input checked="" type="checkbox"/>                                                                                                                                                                                                                                                                                                                                                                                                                                                                                                                                                                                                                                      | Page Images <input type="checkbox"/>                      | STN <sup>®</sup> AnaVist™ <input type="checkbox"/>                        |
|                          | Keep & Share <input type="checkbox"/>                                                                                                                                                                                                                                                                                                                                                                                                                                                                                                                                                                                                                                                                                    | <a href="#">SLART</a> <input checked="" type="checkbox"/> | <a href="#">STN Easy</a> <sup>®</sup> <input checked="" type="checkbox"/> |
|                          | Learning Database <input type="checkbox"/>                                                                                                                                                                                                                                                                                                                                                                                                                                                                                                                                                                                                                                                                               | Structures <input type="checkbox"/>                       | STN <sup>®</sup> Viewer™ <input type="checkbox"/>                         |
| <b>Record Content</b>    | <ul style="list-style-type: none"> <li>• <b>NAPRALERT (NATURAL PRODUCTS ALERT)</b> contains bibliographic and factual data on natural products, including information on the pharmacology, biological activity, taxonomic distribution, chemistry of plant, microbial, and animal (including marine) extracts as well as ethnomedicine use records. In addition, the database contains information on the chemistry and pharmacology of secondary metabolites that are derived from natural sources and that have known structure.</li> <li>• The records in this file contain bibliographic information and factual data on natural products, including CAS Registry Numbers for many chemical constituents.</li> </ul> |                                                           |                                                                           |
| <b>File Size</b>         | 187,821 bibliographic records containing information for over 155,000 natural products and 181,895 organisms (07/2013)                                                                                                                                                                                                                                                                                                                                                                                                                                                                                                                                                                                                   |                                                           |                                                                           |
| <b>Coverage</b>          | <ul style="list-style-type: none"> <li>• 1650 to 2011</li> <li>• Approximately 50% of the file is from systematic survey of the literature from 1975 to 2011. The remaining records were obtained by selective retrospective indexing dating back to 1650</li> </ul>                                                                                                                                                                                                                                                                                                                                                                                                                                                     |                                                           |                                                                           |
| <b>Updates</b>           | <ul style="list-style-type: none"> <li>• Occasional updates as information becomes available</li> <li>• Automatic current-awareness searches (SDIs) are not available</li> </ul>                                                                                                                                                                                                                                                                                                                                                                                                                                                                                                                                         |                                                           |                                                                           |
| <b>Language</b>          | English                                                                                                                                                                                                                                                                                                                                                                                                                                                                                                                                                                                                                                                                                                                  |                                                           |                                                                           |
| <b>Database Producer</b> | Program for Collaborative Research in the<br>Pharmaceutical Sciences<br>College of Pharmacy<br>University of Illinois at Chicago<br>Chicago, Illinois 60680 USA<br>Phone: 312-996-2246<br>Fax: 312-996-7107                                                                                                                                                                                                                                                                                                                                                                                                                                                                                                              |                                                           |                                                                           |

## Sample Records

## DISPLAY IALL

ACCESSION NUMBER: 2012:7757 NAPRALERT  
DOCUMENT NUMBER: L33123  
TITLE: MUTAGENICITY OF FOUR NATURAL FLAVORS: CLOVE, CINNAMON, THYME  
AND ZATARIA MULTIFLORA BOISS  
AUTHOR: SHOEIBI S H; RAHIMIFARD N; PIROUZ B; YALFANI R; PAKZAD S R;  
MIRAB S S; PIRALI H M  
CORPORATE SOURCE: FOOD DRUG LAB RESEARCH CENTER, TEHRAN IRAN  
SOURCE: J MED PLANTS (2009) 8 (5) p. 89-96.  
DOCUMENT TYPE: Paper; (Research paper)  
LANGUAGE: ENGLISH  
CHARACTER COUNT: 1680  
ORGN Class: DICOT Family: MYRTACEAE Genus: SYZYGIIUM Species: AROMATICUM  
Synonym(s): EUGENIA CARYOPHYLLATA  
Organism part: DRIED FLOWER BUDS  
TYPE OF STUDY (STY): IN VITRO. Classification (CC): MUTAGENIC ACTIVITY  
Extract type: ESSENTIAL OIL  
Dosage Information: AGAR PLATE; CONC USED: 1 MG per ML  
Pathological system: SALMONELLA TYPHIMURIUM  
Qualitative results: ACTIVE  
Comment(s): SEE ARTICLE FOR OTHER TEST RESULTS. VS.AMES MUTAGENICITY  
ASSAY.  
ORGN Class: DICOT Family: LAURACEAE Genus: CINNAMOMUM Species: ZEYLANICUM  
Organism part: DRIED BARK  
TYPE OF STUDY (STY): IN VITRO. Classification (CC): MUTAGENIC ACTIVITY  
Extract type: ESSENTIAL OIL  
Dosage Information: AGAR PLATE; CONC USED: 2 MG per ML  
Pathological system: SALMONELLA TYPHIMURIUM  
Qualitative results: INACTIVE  
Comment(s): VS.AMES MUTAGENICITY ASSAY. SEE ARTICLE FOR OTHER TEST  
RESULTS.  
ORGN Class: DICOT Family: LAMIACEAE Genus: THYMUS Species: VULGARIS  
Organism part: DRIED AERIAL PARTS  
TYPE OF STUDY (STY): IN VITRO. Classification (CC): MUTAGENIC ACTIVITY  
Extract type: ESSENTIAL OIL  
Dosage Information: AGAR PLATE; CONC USED: 2 MG per ML  
Pathological system: SALMONELLA TYPHIMURIUM  
Qualitative results: INACTIVE  
Comment(s): VS.AMES MUTAGENICITY ASSAY. SEE ARTICLE FOR OTHER TEST  
RESULTS.  
ORGN Class: DICOT Family: LAMIACEAE Genus: ZATARIA Species: MULTIFLORA  
Organism part: PART NOT SPECIFIED  
TYPE OF STUDY (STY): IN VITRO. Classification (CC): MUTAGENIC ACTIVITY  
Extract type: ESSENTIAL OIL  
Dosage Information: AGAR PLATE; CONC USED: 2 MG per ML  
Pathological system: SALMONELLA TYPHIMURIUM



## IMS New Product Focus

### Description

**IMS New Product Focus** tracks worldwide pharmaceutical product launches, records the very first launch of a product in a particular country (New Active Substance) and identifies the indication and price (when available) at the time of the initial launch. Included are product name and composition, manufacturer's name and, where applicable, parent company, therapeutic class code, ingredients and package insert information.

IMS New Product Focus can be used to analyze the success of a new product launch and assess market penetration.

### Subject Coverage

**IMS New Product Focus** covers 50 major world markets. Each record provides the following information for each product:

- composition (including form and dose)
- ingredients and local trade name
- therapeutic class code and indications (when available)
- manufacturing company
- first launch country and date, and subsequent launches
- presentation (pack information)
- launch price data (where available)

Price information includes hospital and retail price, if available. Biotechnology products are also identified, as well as first world launches of new chemical entities.

### Date Coverage

1982 to the present

### Update Frequency

Monthly

### Geographic Coverage

International

### Document Types

Newsletters

### Publisher

IMS New Product Focus is produced by IMS Health. All questions concerning the database should be directed to:



IMS Health  
Customer Services Dept., Global Services  
210 Pentonville Road  
London, N1 9JY  
England

**Telephone:** +44 0207-393-5888  
**Fax:** +44 0207-393-5346  
**E-Mail:** [service@imshealth.com](mailto:service@imshealth.com)  
**Web site:** [www.imshealth.com](http://www.imshealth.com)

In addition to [Search Options](#), other tools available for searching are [Limit Options](#), [Browse Fields](#), ["Narrow Results By" Limiters](#), and [Lookup Citation](#). Each is listed separately below. Some data can be searched using more than one tool.

Full text &lt; Back to results

&lt; Previous

 Add to selected items Save to My Research  EmailTI  
PUB,PD**DUOALMETEC****IMS New Product Focus** (Apr 28, 2014).

TX,FT

 Full Text [Translate](#)**New Product Focus - Launch Details**

CO

**Company Information**


|                 |                   |
|-----------------|-------------------|
| Company Name:   | MERCK SHARP DOHME |
| Parent Company: | MERCK & CO        |

**Product Information**

|                             |                                                                                        |
|-----------------------------|----------------------------------------------------------------------------------------|
| Trade Name:                 | DUOALMETEC                                                                             |
| Composition:                | amlodipine; olmesartan medoxomil                                                       |
| Launch Country:             | Mexico                                                                                 |
| Product Launch Date:        | 01 May 2013                                                                            |
| Therapeutic Classification: | C9D (Angiotensin-II Antagonists)                                                       |
| Indications on Pack:        | Hypertension                                                                           |
| Drug Status:                | Branded; Existing Chemical Entity; Non-Biotechnology Product; Includes Package Pricing |

**New Product Focus - Pack Details****Pack Information**

|                                   |                                                                                                                                                                                                                                                                                                |
|-----------------------------------|------------------------------------------------------------------------------------------------------------------------------------------------------------------------------------------------------------------------------------------------------------------------------------------------|
| Number of Ingredients:            | 2                                                                                                                                                                                                                                                                                              |
| Number of Packs:                  | 6                                                                                                                                                                                                                                                                                              |
| Dose Form:                        | tabs                                                                                                                                                                                                                                                                                           |
| Composition (Active Ingredients): | tabs a: amlodipine besilate, 5 mg; olmesartan medoxomil base, 20 mg;<br>tabs b: amlodipine besilate, 5 mg; olmesartan medoxomil base, 20 mg;<br>tabs c: amlodipine besilate, 10 mg; olmesartan medoxomil base, 40 mg;<br>tabs d: amlodipine besilate, 10 mg; olmesartan medoxomil base, 40 mg; |

☐ Indexing (details)  Cite

|               |                            |                                                                                                                                                                                                                                                                                                                                                                                 |
|---------------|----------------------------|---------------------------------------------------------------------------------------------------------------------------------------------------------------------------------------------------------------------------------------------------------------------------------------------------------------------------------------------------------------------------------|
| <b>NCE</b>    | <b>New chemical entity</b> | No                                                                                                                                                                                                                                                                                                                                                                              |
|               | <b>Numeric indexing</b>    | Number of ingredients: 2;<br>Number of packs: 6                                                                                                                                                                                                                                                                                                                                 |
| <b>TN</b>     | <b>Trade name</b>          | <a href="#">DUOALMETEC</a>                                                                                                                                                                                                                                                                                                                                                      |
|               | <b>Company</b>             | <a href="#">DUOALMETEC</a>                                                                                                                                                                                                                                                                                                                                                      |
| <b>TC</b>     | <b>Therapeutic class</b>   | <a href="#">C9D: Angiotensin-II Antagonists</a>                                                                                                                                                                                                                                                                                                                                 |
| <b>IND</b>    | <b>Indication</b>          | <a href="#">Hypertension</a>                                                                                                                                                                                                                                                                                                                                                    |
| <b>GN</b>     | <b>Generic name</b>        | amlodipine, olmesartan medoxomil                                                                                                                                                                                                                                                                                                                                                |
| <b>ST</b>     | <b>Drug status</b>         | Branded                                                                                                                                                                                                                                                                                                                                                                         |
| <b>ELDT</b>   | <b>Product launch date</b> | 2013-05-01                                                                                                                                                                                                                                                                                                                                                                      |
| <b>CO</b>     | <b>Originator</b>          | MERCK SHARP DOHME Parent: MERCK & CO                                                                                                                                                                                                                                                                                                                                            |
| <b>TI</b>     | <b>Title</b>               | DUOALMETEC                                                                                                                                                                                                                                                                                                                                                                      |
| <b>CLD</b>    | <b>Phase</b>               | in Mexico.                                                                                                                                                                                                                                                                                                                                                                      |
| <b>LA</b>     | <b>Language</b>            | English                                                                                                                                                                                                                                                                                                                                                                         |
| <b>DTYPE</b>  | <b>Document type</b>       | Product Launch                                                                                                                                                                                                                                                                                                                                                                  |
| <b>PUB</b>    | <b>Publication title</b>   | <a href="#">IMS New Product Focus</a>                                                                                                                                                                                                                                                                                                                                           |
| <b>PSTYPE</b> | <b>Publication type</b>    | Newsletter                                                                                                                                                                                                                                                                                                                                                                      |
| <b>NT</b>     | <b>Notes</b>               | Package/Price: tabs a 14: MXN 408.200 (RPP)(Mexican Peso);<br>Package/Price: tabs b 28: MXN 785.090 (RPP)(Mexican Peso);<br>Package/Price: tabs c 14: MXN 408.200 (RPP)(Mexican Peso);<br>Package/Price: tabs d 28: MXN 785.090 (RPP)(Mexican Peso);<br>Package/Price: tabs e 14: MXN 408.200 (RPP)(Mexican Peso);<br>Package/Price: tabs f 28: MXN 785.090 (RPP)(Mexican Peso) |
| <b>AV</b>     | <b>Availability</b>        | Includes package pricing                                                                                                                                                                                                                                                                                                                                                        |
| <b>PD</b>     | <b>Publication date</b>    | Apr 28, 2014                                                                                                                                                                                                                                                                                                                                                                    |
| <b>DSTAT</b>  | <b>Document status</b>     | New                                                                                                                                                                                                                                                                                                                                                                             |
|               | <b>Source attribution</b>  | IMS New Product Focus, © Publisher specific                                                                                                                                                                                                                                                                                                                                     |
| <b>AN</b>     | <b>Accession number</b>    | 1494126                                                                                                                                                                                                                                                                                                                                                                         |
|               | <b>Document URL</b>        | <a href="http://search.proquest.com/professional/docview/1514784222?accountid=137296">http://search.proquest.com/professional/docview/1514784222?accountid=137296</a>                                                                                                                                                                                                           |
| <b>FAV</b>    | <b>First available</b>     | 2014-04-11                                                                                                                                                                                                                                                                                                                                                                      |
| <b>UD</b>     | <b>Updates</b>             | 2014-04-11                                                                                                                                                                                                                                                                                                                                                                      |
|               | <b>Database</b>            | IMS New Product Focus (1982 - current)                                                                                                                                                                                                                                                                                                                                          |

## IMSRESEARCH (IMS LifeCycle, R&D Focus)

---

|                                                                                                                                                                          |                                                                                                                                                                                                                                                                                                                                                                                                                                                                                                                                                                                                                                                                                                                                                                                                                                                                                                                                              |                       |                                                                                                                                                                          |                                                                                                                                                                                                     |  |  |  |                               |                   |  |  |  |                                                             |                                     |             |                          |                                                    |                                  |                                     |                       |                                     |                                                                          |                   |                          |            |                          |                                                   |
|--------------------------------------------------------------------------------------------------------------------------------------------------------------------------|----------------------------------------------------------------------------------------------------------------------------------------------------------------------------------------------------------------------------------------------------------------------------------------------------------------------------------------------------------------------------------------------------------------------------------------------------------------------------------------------------------------------------------------------------------------------------------------------------------------------------------------------------------------------------------------------------------------------------------------------------------------------------------------------------------------------------------------------------------------------------------------------------------------------------------------------|-----------------------|--------------------------------------------------------------------------------------------------------------------------------------------------------------------------|-----------------------------------------------------------------------------------------------------------------------------------------------------------------------------------------------------|--|--|--|-------------------------------|-------------------|--|--|--|-------------------------------------------------------------|-------------------------------------|-------------|--------------------------|----------------------------------------------------|----------------------------------|-------------------------------------|-----------------------|-------------------------------------|--------------------------------------------------------------------------|-------------------|--------------------------|------------|--------------------------|---------------------------------------------------|
| <b>Subject Coverage</b>                                                                                                                                                  | <ul style="list-style-type: none"> <li>• All phases of drug development worldwide</li> <li>• Biotechnological products</li> <li>• New formulations</li> </ul>                                                                                                                                                                                                                                                                                                                                                                                                                                                                                                                                                                                                                                                                                                                                                                                |                       |                                                                                                                                                                          |                                                                                                                                                                                                     |  |  |  |                               |                   |  |  |  |                                                             |                                     |             |                          |                                                    |                                  |                                     |                       |                                     |                                                                          |                   |                          |            |                          |                                                   |
| <b>File Type</b>                                                                                                                                                         | Substance                                                                                                                                                                                                                                                                                                                                                                                                                                                                                                                                                                                                                                                                                                                                                                                                                                                                                                                                    |                       |                                                                                                                                                                          |                                                                                                                                                                                                     |  |  |  |                               |                   |  |  |  |                                                             |                                     |             |                          |                                                    |                                  |                                     |                       |                                     |                                                                          |                   |                          |            |                          |                                                   |
| <b>Features</b>                                                                                                                                                          | <table border="0" style="width: 100%;"> <tr> <td>Thesaurus</td> <td>None</td> <td></td> <td></td> <td></td> </tr> <tr> <td><a href="#">Alerts (SDIs)</a></td> <td>Weekly or Monthly</td> <td></td> <td></td> <td></td> </tr> <tr> <td><a href="#">CAS Registry Number<sup>®</sup> Identifiers</a></td> <td><input checked="" type="checkbox"/></td> <td>Page Images</td> <td><input type="checkbox"/></td> <td>STN<sup>®</sup> AnaVist™ <input type="checkbox"/></td> </tr> <tr> <td><a href="#">Keep &amp; Share</a></td> <td><input checked="" type="checkbox"/></td> <td><a href="#">SLART</a></td> <td><input checked="" type="checkbox"/></td> <td><a href="#">STN Easy<sup>®</sup></a> <input checked="" type="checkbox"/></td> </tr> <tr> <td>Learning Database</td> <td><input type="checkbox"/></td> <td>Structures</td> <td><input type="checkbox"/></td> <td>STN<sup>®</sup> Viewer™ <input type="checkbox"/></td> </tr> </table> |                       | Thesaurus                                                                                                                                                                | None                                                                                                                                                                                                |  |  |  | <a href="#">Alerts (SDIs)</a> | Weekly or Monthly |  |  |  | <a href="#">CAS Registry Number<sup>®</sup> Identifiers</a> | <input checked="" type="checkbox"/> | Page Images | <input type="checkbox"/> | STN <sup>®</sup> AnaVist™ <input type="checkbox"/> | <a href="#">Keep &amp; Share</a> | <input checked="" type="checkbox"/> | <a href="#">SLART</a> | <input checked="" type="checkbox"/> | <a href="#">STN Easy<sup>®</sup></a> <input checked="" type="checkbox"/> | Learning Database | <input type="checkbox"/> | Structures | <input type="checkbox"/> | STN <sup>®</sup> Viewer™ <input type="checkbox"/> |
| Thesaurus                                                                                                                                                                | None                                                                                                                                                                                                                                                                                                                                                                                                                                                                                                                                                                                                                                                                                                                                                                                                                                                                                                                                         |                       |                                                                                                                                                                          |                                                                                                                                                                                                     |  |  |  |                               |                   |  |  |  |                                                             |                                     |             |                          |                                                    |                                  |                                     |                       |                                     |                                                                          |                   |                          |            |                          |                                                   |
| <a href="#">Alerts (SDIs)</a>                                                                                                                                            | Weekly or Monthly                                                                                                                                                                                                                                                                                                                                                                                                                                                                                                                                                                                                                                                                                                                                                                                                                                                                                                                            |                       |                                                                                                                                                                          |                                                                                                                                                                                                     |  |  |  |                               |                   |  |  |  |                                                             |                                     |             |                          |                                                    |                                  |                                     |                       |                                     |                                                                          |                   |                          |            |                          |                                                   |
| <a href="#">CAS Registry Number<sup>®</sup> Identifiers</a>                                                                                                              | <input checked="" type="checkbox"/>                                                                                                                                                                                                                                                                                                                                                                                                                                                                                                                                                                                                                                                                                                                                                                                                                                                                                                          | Page Images           | <input type="checkbox"/>                                                                                                                                                 | STN <sup>®</sup> AnaVist™ <input type="checkbox"/>                                                                                                                                                  |  |  |  |                               |                   |  |  |  |                                                             |                                     |             |                          |                                                    |                                  |                                     |                       |                                     |                                                                          |                   |                          |            |                          |                                                   |
| <a href="#">Keep &amp; Share</a>                                                                                                                                         | <input checked="" type="checkbox"/>                                                                                                                                                                                                                                                                                                                                                                                                                                                                                                                                                                                                                                                                                                                                                                                                                                                                                                          | <a href="#">SLART</a> | <input checked="" type="checkbox"/>                                                                                                                                      | <a href="#">STN Easy<sup>®</sup></a> <input checked="" type="checkbox"/>                                                                                                                            |  |  |  |                               |                   |  |  |  |                                                             |                                     |             |                          |                                                    |                                  |                                     |                       |                                     |                                                                          |                   |                          |            |                          |                                                   |
| Learning Database                                                                                                                                                        | <input type="checkbox"/>                                                                                                                                                                                                                                                                                                                                                                                                                                                                                                                                                                                                                                                                                                                                                                                                                                                                                                                     | Structures            | <input type="checkbox"/>                                                                                                                                                 | STN <sup>®</sup> Viewer™ <input type="checkbox"/>                                                                                                                                                   |  |  |  |                               |                   |  |  |  |                                                             |                                     |             |                          |                                                    |                                  |                                     |                       |                                     |                                                                          |                   |                          |            |                          |                                                   |
| <b>Record Content</b>                                                                                                                                                    | <table border="0" style="width: 100%;"> <tr> <td style="vertical-align: top;"> <ul style="list-style-type: none"> <li>• Substance information</li> <li>• CAS Registry Number and Chemical Name</li> <li>• Structures</li> <li>• Pharmacology</li> </ul> </td> <td style="vertical-align: top;"> <ul style="list-style-type: none"> <li>• Development and licensing status worldwide</li> <li>• Scientific and commercial summaries</li> <li>• Abstracts of significant scientific papers</li> </ul> </td> </tr> </table>                                                                                                                                                                                                                                                                                                                                                                                                                     |                       | <ul style="list-style-type: none"> <li>• Substance information</li> <li>• CAS Registry Number and Chemical Name</li> <li>• Structures</li> <li>• Pharmacology</li> </ul> | <ul style="list-style-type: none"> <li>• Development and licensing status worldwide</li> <li>• Scientific and commercial summaries</li> <li>• Abstracts of significant scientific papers</li> </ul> |  |  |  |                               |                   |  |  |  |                                                             |                                     |             |                          |                                                    |                                  |                                     |                       |                                     |                                                                          |                   |                          |            |                          |                                                   |
| <ul style="list-style-type: none"> <li>• Substance information</li> <li>• CAS Registry Number and Chemical Name</li> <li>• Structures</li> <li>• Pharmacology</li> </ul> | <ul style="list-style-type: none"> <li>• Development and licensing status worldwide</li> <li>• Scientific and commercial summaries</li> <li>• Abstracts of significant scientific papers</li> </ul>                                                                                                                                                                                                                                                                                                                                                                                                                                                                                                                                                                                                                                                                                                                                          |                       |                                                                                                                                                                          |                                                                                                                                                                                                     |  |  |  |                               |                   |  |  |  |                                                             |                                     |             |                          |                                                    |                                  |                                     |                       |                                     |                                                                          |                   |                          |            |                          |                                                   |
| <b>File Size</b>                                                                                                                                                         | More than 35,260 records (12/13)                                                                                                                                                                                                                                                                                                                                                                                                                                                                                                                                                                                                                                                                                                                                                                                                                                                                                                             |                       |                                                                                                                                                                          |                                                                                                                                                                                                     |  |  |  |                               |                   |  |  |  |                                                             |                                     |             |                          |                                                    |                                  |                                     |                       |                                     |                                                                          |                   |                          |            |                          |                                                   |
| <b>Coverage</b>                                                                                                                                                          | 1977-present                                                                                                                                                                                                                                                                                                                                                                                                                                                                                                                                                                                                                                                                                                                                                                                                                                                                                                                                 |                       |                                                                                                                                                                          |                                                                                                                                                                                                     |  |  |  |                               |                   |  |  |  |                                                             |                                     |             |                          |                                                    |                                  |                                     |                       |                                     |                                                                          |                   |                          |            |                          |                                                   |
| <b>Updates</b>                                                                                                                                                           | Weekly                                                                                                                                                                                                                                                                                                                                                                                                                                                                                                                                                                                                                                                                                                                                                                                                                                                                                                                                       |                       |                                                                                                                                                                          |                                                                                                                                                                                                     |  |  |  |                               |                   |  |  |  |                                                             |                                     |             |                          |                                                    |                                  |                                     |                       |                                     |                                                                          |                   |                          |            |                          |                                                   |
| <b>Language</b>                                                                                                                                                          | English                                                                                                                                                                                                                                                                                                                                                                                                                                                                                                                                                                                                                                                                                                                                                                                                                                                                                                                                      |                       |                                                                                                                                                                          |                                                                                                                                                                                                     |  |  |  |                               |                   |  |  |  |                                                             |                                     |             |                          |                                                    |                                  |                                     |                       |                                     |                                                                          |                   |                          |            |                          |                                                   |
| <b>Database Producer</b>                                                                                                                                                 | IMS HEALTH<br>210 Pentonville Road<br>London N1 9JY<br>United Kingdom<br>Phone: (+44) 020 3075 5888<br>Email: <a href="mailto:info@uk.imshealth.com">info@uk.imshealth.com</a><br>Web: <a href="http://www.imshealth.com">http://www.imshealth.com</a>                                                                                                                                                                                                                                                                                                                                                                                                                                                                                                                                                                                                                                                                                       |                       |                                                                                                                                                                          |                                                                                                                                                                                                     |  |  |  |                               |                   |  |  |  |                                                             |                                     |             |                          |                                                    |                                  |                                     |                       |                                     |                                                                          |                   |                          |            |                          |                                                   |

---

**IMSRESEARCH**

---

**Sources**

Information is gathered from direct reports from companies on their research and development, conferences, patent and journal literature, and attendance at symposia on medical, clinical, and research subjects.

---

**User Aids**

- Anatomical Therapeutic Classification Codes (available from the producer)
  - Online Helps (HELP DIRECTORY lists all help messages available)
  - STNGUIDE
- 

**Clusters**

- BIOSCIENCE
  - CASRNS
  - IMSBASES
  - PHARMACOLOGY
- [STN Database Clusters](#) information (PDF).
- 

**Pricing**

Enter HELP COST at an arrow prompt (=>).

---

## Sample Records

## DISPLAY IALL

ACCESSION NUMBER: 2010:357 IMSRESEARCH  
 SOURCE: R&D Focus, (04 Mar 2010)  
 DOCUMENT NUMBER: 2500677  
 STATUS: NEW DRUG  
 LABORATORY NAME: ABT 072  
 STRUCTURE:

STRUCTURE DIAGRAM IS NOT AVAILABLE

CLASSIFICATION: J5B1 Viral Hepatitis Products  
 INDICATION: hepatitis C  
 ACTION: RNA polymerase inhibitor  
 ADMINISTRATION: oral  
 HIGHEST DEV. PHASE: Phase II (40)  
 ENTRY DATE: Entered STN: 8 Mar 2010  
 Last Updated on STN: 6 Apr 2010

LATEST INFORMATION: 04 March 2010 : Abbott and Enanta announced on 2 March 2010 the initiation of a phase II trial of ABT 450, ABT 333 and ABT 072 in treatment-naive patients with hepatitis C virus (HCV) genotype 1 infection. ABT 450, a protease inhibitor developed by Abbott and Enanta, and ABT 333 and ABT 072, two non-nucleoside polymerase inhibitors developed exclusively by Abbott, will be dosed individually in combination with standard of care (SOC). The study will evaluate the safety, tolerability, pharmacokinetics and antiviral activity of the agents. After a three-day monotherapy period, each antiviral agent will be administered with pegIFN and ribavirin (SOC) for 12 weeks, followed by SOC alone for an additional 36 weeks.

## CURRENT DEVELOPMENT STATUS:

| Type          | Status   | Stage | Region        | Indication  |
|---------------|----------|-------|---------------|-------------|
| Highest Phase | Phase II | 40    |               |             |
| Phase         | Phase II | 40    | United States | hepatitis C |

## COMPANY INFORMATION:

| Type       | Company | Nationality | Corporation            |
|------------|---------|-------------|------------------------|
| Originator | Abbott  | USA         | Abbott (United States) |

## COMMERCIAL SUMMARY:

Commercial overview. Overview

Abbott is developing ABT 072, a non-nucleoside polymerase inhibitor, for the treatment of hepatitis C virus (HCV) infection. A phase II trial of the agent initiated in February 2010 in patients with HCV genotype 1 infection.

R&D progress. \*\*Hepatitis C\*\*

Phase II, Abbott, USA.---DESIGN: Trial started - Feb 2010. A randomized, double-blind, parallel assignment phase II trial of ABT 450, ABT 333 and ABT 072 has been initiated in treatment-naive patients with hepatitis C virus (HCV) genotype 1 infection. The agents will be dosed individually in combination with standard of care (SOC). The study will evaluate the safety, tolerability, pharmacokinetics and antiviral activity of the agents. After a three-day monotherapy period, each antiviral agent will be administered with pegIFN and ribavirin (SOC) for 12 weeks, followed by SOC alone for an additional 36 weeks.

## CBNB (Chemical Business NewsBase)

|                          |                                                                                                                                                                                                                                                          |                                     |                       |                                     |                                      |                                     |
|--------------------------|----------------------------------------------------------------------------------------------------------------------------------------------------------------------------------------------------------------------------------------------------------|-------------------------------------|-----------------------|-------------------------------------|--------------------------------------|-------------------------------------|
| <b>Subject Coverage</b>  | News affecting the chemical industry: <ul style="list-style-type: none"> <li>• Company information</li> <li>• Products and production</li> <li>• Market information</li> <li>• Environmental aspects</li> <li>• Legal aspects and regulations</li> </ul> |                                     |                       |                                     |                                      |                                     |
| <b>File Type</b>         | Bibliographic                                                                                                                                                                                                                                            |                                     |                       |                                     |                                      |                                     |
| <b>Features</b>          | Thesaurus                                                                                                                                                                                                                                                | None                                |                       |                                     |                                      |                                     |
|                          | <a href="#">Alerts (SDIs)</a>                                                                                                                                                                                                                            | Weekly                              |                       |                                     |                                      |                                     |
|                          | <a href="#">CAS Registry Number<sup>®</sup> Identifiers</a>                                                                                                                                                                                              | <input checked="" type="checkbox"/> | Page Images           | <input type="checkbox"/>            | STN <sup>®</sup> AnaVist™            | <input type="checkbox"/>            |
|                          | <a href="#">Keep &amp; Share</a>                                                                                                                                                                                                                         | <input checked="" type="checkbox"/> | <a href="#">SLART</a> | <input checked="" type="checkbox"/> | <a href="#">STN Easy<sup>®</sup></a> | <input checked="" type="checkbox"/> |
|                          | Learning Database                                                                                                                                                                                                                                        | <input type="checkbox"/>            | Structures            | <input type="checkbox"/>            | STN <sup>®</sup> Viewer™             | <input type="checkbox"/>            |
| <b>Record Content</b>    | Records contain bibliographic information, controlled indexing for company and country names, chemical names and important concepts, CAS Registry Numbers, and an abstract.                                                                              |                                     |                       |                                     |                                      |                                     |
| <b>File Size</b>         | More than 1.65 million records (7/2014)                                                                                                                                                                                                                  |                                     |                       |                                     |                                      |                                     |
| <b>Coverage</b>          | 1984-present                                                                                                                                                                                                                                             |                                     |                       |                                     |                                      |                                     |
| <b>Updates</b>           | Daily                                                                                                                                                                                                                                                    |                                     |                       |                                     |                                      |                                     |
| <b>Language</b>          | English                                                                                                                                                                                                                                                  |                                     |                       |                                     |                                      |                                     |
| <b>Database Producer</b> | Elsevier Engineering Information Inc.<br>1 Castle Point Terrace<br>Hoboken, New Jersey 07030-5996<br>USA<br>Phone: +1 201 216-8500<br>Fax: +1 201 216-8532<br>Email: ei@ei.org<br>Copyright Holder                                                       |                                     |                       |                                     |                                      |                                     |



**Database  
Supplier**

FIZ Karlsruhe  
 STN Europe  
 P.O. Box 2465  
 76012 Karlsruhe  
 Germany  
 Phone: +49-7247-808-555  
 Fax: +49-7247-808-259  
 Email: [helpdesk@fiz-karlsruhe.de](mailto:helpdesk@fiz-karlsruhe.de)

**Sources**

- Newspapers
- Journals
- Company reports
- Stockbroker reports
- Market research reports
- Books
- Press releases
- Trade literature
- Advertisements
- Government and EU publications
- Directories

**User Aids**

- CBNB User Manual (incl. Chemicals Index) \*
  - CBNB Core Sources List  
[http://www.stn-international.de/fileadmin/be\\_user/STN/pdf/database\\_details/CBNB\\_HCSL\\_issue\\_15.pdf](http://www.stn-international.de/fileadmin/be_user/STN/pdf/database_details/CBNB_HCSL_issue_15.pdf)
  - Online Helps (HELP DIRECTORY lists all help messages available)
  - STNGUIDE
- \* available from producer

**Clusters**

- AGRICULTURE
- ALLBIB
- BUSINESS
- CASRNS
- CHEMENG
- CHEMISTRY
- COMPANIES
- ENVIRONMENT
- FUELS
- GOVREGS
- HEALTH
- MATERIALS
- PETROLEUM
- PHARMACOLOGY
- POLYMERS

[STN Database Clusters](#) information (PDF)

**Pricing**

Enter HELP COST at an arrow prompt.



**DISPLAY ALL OF PRESS RELEASE**

AN 26(47):64544 CBNB

TI Potash One agrees to friendly takeover by K+S for C\$4.50 per share in cash.

SO (22 Nov 2010), (200-899 words)

Availability: K+S AG, Bertha-von-Suttner-Strasse 7, 34131 Kassel, Germany, tel: +49 5619 3010, fax: +49 5619 30117 53, website:

[www.k-plus-s.com](http://www.k-plus-s.com)

DT Press Release; (Column)

LA English

PY 2010

AB On 22 Nov 2010, K+S AG and Potash One Inc announced that they have entered into a Support Agreement pursuant to which K+S will make an offer to acquire all of the issued and outstanding common shares of Potash One at a price of C\$4.50 per share in cash for total consideration of approximately C\$434 M (EUR 311 M). The offer represents a: 24.3% premium to the closing price of Potash One shares on 19 Nov 2010 on the Toronto Stock Exchange; 31.3% premium over the 10-day weighted average trading price of the shares up to and including 19 Nov 2010; and 82.2% premium to Potash One's share price of CAD 2.47 on 16 Aug 2010, the day prior to Potash Corp's rejection of BHP Billiton's unsolicited proposal. The Potash One Board of Directors has unanimously determined that the transaction is fair to Potash One shareholders and is in the best interests of the company and its shareholders. The Board recommends that shareholders tender their common shares to the offer. Potash One's Board has received an opinion from GMP Securities L.P. that the consideration to be received by the Potash One shareholders under the offer is fair from a financial point of view to those shareholders. Potash One holds several potash exploration licenses in the Canadian province of Saskatchewan, including the Legacy Project, an advanced greenfield project to develop a potash solution mine. K+S estimates production capacity of up to 2.7 M tonnes/y of potassium chloride. The realisation of this production capacity would represent an approximately \$2.5 bn capital investment into Saskatchewan and create up to 300 highly-skilled jobs. The project headquarters will be located in Saskatchewan, Canada. K+S expects initial production no earlier than 2015.

CC MS-06

Fertilizers

CO Kali und Salz (K+S); Potash One

GT 1112: GERMANY; 2103: CANADA

CT mergers and acquisitions; investment; plant capacity; employment

CN potassium chloride

RN 7447-40-7

SIC 28194 Potassium and Sodium Compounds



# Fontes de Informações Patentárias (Gratuitas)

- INPI (<https://gru.inpi.gov.br/pePI/servlet/LoginController?action=login>)
- USPTO (<http://patft.uspto.gov>)
- USPTO PAIR (<http://portal.uspto.gov/pair/PublicPair>)
- Espacenet (<http://worldwide.espacenet.com>)
- Epoline Register Plus (<https://register.epo.org/regviewer>)
- Google patents, WIPOI, Etc...
- Intellogist ([www.intellogist.com](http://www.intellogist.com))

**Marca****Patente****Desenho Industrial****Indicação Geográfica****Programa de  
Computador****Topografia de  
Circuitos Integrados****Transferência de  
Tecnologia****Informação Tecnológica  
de Patentes****NOTA:**

- Para efeitos legais a Revista Eletrônica da Propriedade Industrial (RPI) é o único canal destinado a publicar os atos, despachos e decisões relacionados às atividades da Autarquia.
- O acervo contido na base de dados está restrito a documentos publicados a partir do ano 2000, cujos dados foram publicados oficialmente na Revista da Propriedade Industrial.



BRASIL

Acesso à informação

Participe

Serviços

Legislação

Canais

# Instituto Nacional da Propriedade Industrial

Ministério do Desenvolvimento, Indústria e Comércio Exterior






Consulta à Base de Dados do INPI

[ [Início](#) | [Ajuda?](#)  | [Login](#) | [Cadastre-se aqui.](#) ]

» Consultar por: **Base Patentes** | [Pesquisa Básica](#) | [Calendário](#) | [Finalizar Sessão](#)

## PESQUISA AVANÇADA

Forneça abaixo as chaves de pesquisa desejadas. Evite o uso de frases ou palavras genéricas.

|                                                                      |                                                                                                                                           |                                                                                                                                                      |
|----------------------------------------------------------------------|-------------------------------------------------------------------------------------------------------------------------------------------|------------------------------------------------------------------------------------------------------------------------------------------------------|
| <input checked="" type="radio"/> <b>Números</b>                      | (21) Nº do Pedido: <input type="text"/>                | <input type="radio"/> Calendário de Patentes expiradas/a expirar  |
|                                                                      |                                                                                                                                           | <input type="radio"/> Patente Concedida                           |
|                                                                      | (33)/(31) País/Nº da Prioridade: <input type="text"/>  |                                                                                                                                                      |
|                                                                      | (86) Nº do Depósito (PCT): <input type="text"/>        |                                                                                                                                                      |
| <input checked="" type="radio"/> <b>Datas</b>                        |                                                                                                                                           |                                                                                                                                                      |
| <input checked="" type="radio"/> <b>Classificação</b>                |                                                                                                                                           |                                                                                                                                                      |
| <input checked="" type="radio"/> <b>Palavra Chave</b>                |                                                                                                                                           |                                                                                                                                                      |
| <input checked="" type="radio"/> <b>Depositante/Titular/Inventor</b> |                                                                                                                                           |                                                                                                                                                      |

Nº de Processos por Página:  ▼

Rua Mayrink Veiga, 9 - Centro - RJ - CEP: 20090-910 | Rua São Bento, 1 - Centro - RJ - CEP: 20090-010





## Depósito de pedido nacional de Patente

(21) Nº do Pedido: **MU 8702761-5 U2**

(22) Data do Depósito: 26/10/2007

(43) Data da Publicação: 23/06/2009

(47) Data da Concessão: -

(51) Classificação - IntCL: **E05B 19/00 ; B60R 25/00**

(54) Título: CHAVE CANIVETE COM ESPAÇO RESERVADO PARA ALARME E DISPOSITIVO DE ARMAZENAMENTO DE DADOS  
CHAVE CANIVETE COM ESPAÇO RESERVADO PARA ALARME E DISPOSITIVO DE ARMAZENAMENTO DE DADOS. Pertencente ao ramo de componentes automotivos, compreendido pelo acréscimo a uma chave tipo canivete (1) uma chave deslizante (5) que permite que um mmi pen drive (6) saia da caixa plástica (3) que reveste a chave e os outros componentes, através de um orifício (7) que permite por fim que o usuário acople a entrada especificada pelo mesmo.

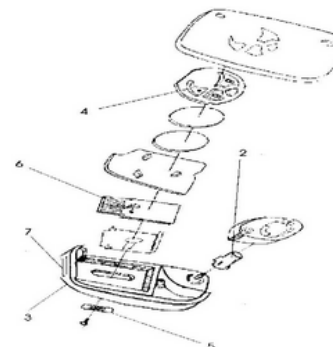
(71) Nome do Depositante: Marcio Zuicker de Camargo Castanho (BR/SP)

(72) Nome do Inventor: Marcio Zuicker de Camargo Castanho

(74) Nome do Procurador: Autoral Patentes e Marcas S/C LTDA.



Documento Publicado



## Petições ?

| Pgo | Protocolo    | Data       | Img | Serviço | Cliente                            | Delivery | Data |
|-----|--------------|------------|-----|---------|------------------------------------|----------|------|
| ✓   | 018080009409 | 20/02/2008 | -   | 206     | Marcio Zuicker de Camargo Castanho |          | -    |
| ✓   | 018070071114 | 26/10/2007 | -   | 200     | Marcio Zuicker de Camargo Castanho |          | -    |

## Publicações ?

| RPI  | Data RPI          | Despacho | Complemento do Despacho |
|------|-------------------|----------|-------------------------|
| 2113 | <b>05/07/2011</b> | 11.1.1   |                         |
| 2098 | <b>22/03/2011</b> | 11.1     |                         |
| 2007 | <b>23/06/2009</b> | 3.1      |                         |
| 1951 | <b>27/05/2008</b> | 2.1      |                         |

# USPTO PATENT FULL-TEXT AND IMAGE DATABASE

[Home](#)[Quick](#)[Advanced](#)[Pat Num](#)[Help](#)[View Cart](#)

Data current through August 25, 2015..

Query [\[Help\]](#)

Examples:

ttl/(tennis and (racquet or racket))

isd/1/8/2002 and motorcycle

in/newmar-julie

Select Years [\[Help\]](#)

1976 to present [full-text] ▼

Patents from 1790 through 1975 are searchable only by Issue Date, Patent Number, and Current Classification (US, IPC, or CPC).

When searching for specific numbers in the Patent Number field, patent numbers must be seven characters in length, excluding commas, which are optional.

| Field Code | Field Name                                       | Field Code | Field Name                         |
|------------|--------------------------------------------------|------------|------------------------------------|
| PN         | <a href="#">Patent Number</a>                    | IN         | <a href="#">Inventor Name</a>      |
| ISD        | <a href="#">Issue Date</a>                       | IC         | <a href="#">Inventor City</a>      |
| TTL        | <a href="#">Title</a>                            | IS         | <a href="#">Inventor State</a>     |
| ABST       | <a href="#">Abstract</a>                         | ICN        | <a href="#">Inventor Country</a>   |
| ACLM       | <a href="#">Claim(s)</a>                         | AANM       | <a href="#">Applicant Name</a>     |
| SPEC       | <a href="#">Description/Specification</a>        | AACI       | <a href="#">Applicant City</a>     |
| CCL        | <a href="#">Current US Classification</a>        | AAST       | <a href="#">Applicant State</a>    |
| CPC        | <a href="#">Current CPC Classification</a>       | AACO       | <a href="#">Applicant Country</a>  |
| CPCL       | <a href="#">Current CPC Classification Class</a> | AAAT       | <a href="#">Applicant Type</a>     |
| ICL        | <a href="#">International Classification</a>     | LREP       | <a href="#">Attorney or Agent</a>  |
| APN        | <a href="#">Application Serial Number</a>        | AN         | <a href="#">Assignee Name</a>      |
| APD        | <a href="#">Application Date</a>                 | AC         | <a href="#">Assignee City</a>      |
| APT        | <a href="#">Application Type</a>                 | AS         | <a href="#">Assignee State</a>     |
| GOVT       | <a href="#">Government Interest</a>              | ACN        | <a href="#">Assignee Country</a>   |
| FMID       | <a href="#">Patent Family ID</a>                 | EXP        | <a href="#">Primary Examiner</a>   |
| PARN       | <a href="#">Parent Case Information</a>          | EXA        | <a href="#">Assistant Examiner</a> |
| PLAP       | <a href="#">Related US App. Data</a>             | REF        | <a href="#">Referenced By</a>      |

# USPTO PATENT FULL-TEXT AND IMAGE DATABASE

[Home](#)[Quick](#)[Advanced](#)[Pat Num](#)[Help](#)[Next List](#)[Bottom](#)[View Cart](#)

Searching US Patent Collection...

## Results of Search in US Patent Collection db for:

















TTL/(pocket AND tool): 90 patents.

Hits 1 through 50 out of 90

**PAT.  
NO.**

**Title**

- 1 [9,073,192](#)  [Pocket driver tool](#)
- 2 [D732,368](#)  [Multi-purpose pocket tool](#)
- 3 [D731,270](#)  [Pocket field tool bit](#)
- 4 [D705,536](#)  [Two pocket retractable tool pouch for attaching to a tool belt or a body harness vertical strap](#)
- 5 [8,647,026](#)  [Cutting tool with pocket feature for reducing stress](#)
- 6 [D696,918](#)  [Pocket driver tool](#)
- 7 [8,596,933](#)  [Cutting tool having pocket bottom with base and inclined surfaces](#)
- 8 [8,528,215](#)  [Pocket tool, in particular a pocket knife](#)
- 9 [8,403,141](#)  [Tool bag with secure-pocket configuration](#)
- 10 [8,368,318](#)  [Pocket tool with a light pointer](#)
- 11 [8,225,696](#)  [Method of manufacturing a pocket tool](#)
- 12 [D658,964](#)  [Pocket tool with control panel](#)
- 13 [8,091,627](#)  [Stress relief in a pocket of a downhole tool string component](#)
- 14 [8,087,181](#)  [Valve body seat pocket inspection tool](#)
- 15 [8,029,214](#)  [Pocket hole jig tool system](#)
- 16 [D645,722](#)  [Multi-function pocket tool](#)



### Patent eBusiness

- [Electronic Filing](#)
- [Patent Application Information \(PAIR\)](#)
- [Patent Ownership](#)
- [Fees](#)
- [Supplemental Resources & Support](#)

### Patent Information

- [Patent Guidance and General Info](#)
- [Codes, Rules & Manuals](#)
- [Employee & Office Directories](#)
- [Resources & Public Notices](#)

### Patent Searches

- [Patent Official Gazette](#)
- [Search Patents & Applications](#)
- [Search Biological Sequences](#)
- [Copies, Products & Services](#)

### Other

- [Copyrights](#)
- [Trademarks](#)
- [Policy & Law](#)
- [Reports](#)

### Patent Application Information Retrieval

Select New Case

#### Select New Case

\* indicates a required field

You may search for a specific application or conduct a search related to a customer number.

#### Search for Application:

Choose type of number:

- Application Number (EXAMPLE: 99999999 or 99/999999)
- Control Number
- Patent Number
- PCT Number (EXAMPLE: PCT/CCYY/99999 or PCT/CCYYYY/999999)
- Publication Number
- International Design Registration Number (EXAMPLE: DM/999999)

\* Enter number:

If you need help:

- Contact the Patent Electronic Business Center at (866) 217-9197 (toll free) or e-mail [EBC@uspto.gov](mailto:EBC@uspto.gov) for specific questions about Patent Application Information Retrieval (PAIR).
- If you experience technical difficulties or problems with PAIR outside normal Patent Electronic Business Center hours (M-F, 6AM to 12AM ET), please call 1 800-786-9199.
- Send general questions about USPTO programs to the [USPTO Contact Center \(UCC\)](#).



- [Accessibility](#)
- [Privacy Policy](#)
- [Terms of Use](#)
- [Security](#)
- [Emergencies/Security Alerts](#)
- [Information Quality Guidelines](#)

- [Federal Activities Inventory Reform \(FAIR\) Act](#)
- [Notification and Federal Employee Antidiscrimination and Retaliation \(NoFEAR\) Act](#)
- [Budget & Performance](#)
- [Freedom of Information Act \(FOIA\)](#)

- [Department of Commerce NoFEAR Act Report](#)
- [Regulations.gov](#)
- [STOP!Fakes.gov](#)
- [Department of Commerce](#)
- [USA.gov](#)

- [Strategy Targeting Organized Piracy \(STOP!\)](#)
- [Careers](#)
- [Site Index](#)
- [Contact Us](#)
- [USPTO Webmaster](#)



**Patent eBusiness**

- [Electronic Filing](#)
- [Patent Application Information \(PAIR\)](#)
- [Patent Ownership](#)
- [Fees](#)
- [Supplemental Resources & Support](#)

**Patent Information**

[Patent Guidance and General Info](#)

- [Codes, Rules & Manuals](#)
- [Employee & Office Directories](#)
- [Resources & Public Notices](#)

**Patent Searches**

[Patent Official Gazette](#)

- [Search Patents & Applications](#)
- [Search Biological Sequences](#)
- [Copies, Products & Services](#)

**Other**

- [Copyrights](#)
- [Trademarks](#)
- [Policy & Law Reports](#)

**Patent Application Information Retrieval**

[Order Certified Application As Filed](#)   [Order Certified File Wrapper](#)   [View Order List](#)

**10/965,638**   **POCKET TOOL**   **0425202**

|                 |                  |                     |                    |                         |                 |                  |      |                     |                          |             |                    |
|-----------------|------------------|---------------------|--------------------|-------------------------|-----------------|------------------|------|---------------------|--------------------------|-------------|--------------------|
| Select New Case | Application Data | Transaction History | Image File Wrapper | Patent Term Adjustments | Continuity Data | Foreign Priority | Fees | Published Documents | Address & Attorney/Agent | Assignments | Display References |
|-----------------|------------------|---------------------|--------------------|-------------------------|-----------------|------------------|------|---------------------|--------------------------|-------------|--------------------|

**Bibliographic Data**

|                               |                                                          |                                              |                    |
|-------------------------------|----------------------------------------------------------|----------------------------------------------|--------------------|
| Application Number:           | 10/965,638                                               | Correspondence Address Customer Number:      | -                  |
| Filing or 371 (c) Date:       | 10-14-2004                                               | Status:                                      | Patented Case      |
| Application Type:             | Utility                                                  | Status Date:                                 | 11-22-2006         |
| Examiner Name:                | THOMAS, DAVID B                                          | Location:                                    | ELECTRONIC         |
| Group Art Unit:               | 3723                                                     | Location Date:                               | -                  |
| Confirmation Number:          | 8173                                                     | Earliest Publication No:                     | US 2005-0081302 A1 |
| Attorney Docket Number:       | 0425202                                                  | Earliest Publication Date:                   | 04-21-2005         |
| Class / Subclass:             | 007/118                                                  | Patent Number:                               | 7,146,667          |
| First Named Inventor:         | Carl Elsener , Ibach, (CH) <a href="#">all Inventors</a> | Issue Date of Patent:                        | 12-12-2006         |
| First Named Applicant:        | -                                                        | International Registration Number (Hague):   | -                  |
| Entity Status:                | Undiscounted                                             | International Registration Publication Date: | -                  |
| AIA (First Inventor to File): | No                                                       |                                              |                    |

Title of Invention:                      POCKET TOOL

*If you need help:*

- Contact the Patent Electronic Business Center at (866) 217-9197 (toll free) or e-mail [EBC@uspto.gov](mailto:EBC@uspto.gov) for specific questions about Patent Application Information Retrieval (PAIR).
- If you experience technical difficulties or problems with PAIR outside normal Patent Electronic Business Center hours (M-F, 6AM to 12AM ET), please call 1 800-786-9199.
- Send general questions about USPTO programs to the [USPTO Contact Center \(UCC\)](#).



- » [Accessibility](#)
- » [Privacy Policy](#)
- » [Terms of Use](#)
- » [Security](#)
- » [Emergencies/Security Alerts](#)
- » [Information Quality Guidelines](#)

- » [Federal Activities Inventory Reform \(FAIR\) Act](#)
- » [Notification and Federal Employee Antidiscrimination and Retaliation \(NoFEAR\) Act](#)
- » [Budget & Performance](#)
- » [Freedom of Information Act \(FOIA\)](#)

- » [Department of Commerce NoFEAR Act Report](#)
- » [Regulations.gov](#)
- » [STOP!Fakes.gov](#)
- » [Department of Commerce](#)
- » [USA.gov](#)

- » [Strategy Targeting Organized Piracy \(STOP!\)](#)
- » [Careers](#)
- » [Site Index](#)
- » [Contact Us](#)
- » [USPTO Webmaster](#)

**Patent eBusiness**

- Electronic Filing
- Patent Application Information (PAIR)
- Patent Ownership
- Fees
- Supplemental Resources & Support

**Patent Information**

- Patent Guidance and General Info
  - Codes, Rules & Manuals
  - Employee & Office Directories
  - Resources & Public Notices
- Patent Searches
- Patent Official Gazette
  - Search Patents & Applications
  - Search Biological Sequences
  - Copies, Products & Services
- Other
  - Copyrights
  - Trademarks
  - Policy & Law Reports

**Patent Application Information Retrieval**

Order Certified Application As Filed    Order Certified File Wrapper    View Order List

**10/965,638**    **POCKET TOOL**    **0425202**

Select New Case    Application Data    Transaction History    Image File Wrapper    Patent Term Adjustments    Continuity Data    Foreign Priority    Fees    Published Documents    Address & Attorney/Agent    Assignments    Display References

This application is officially maintained in electronic form. To View: Click the desired Document Description. To Download and Print: Check the desired document(s) and click Start Download.

**Available Documents**

| Mail Room Date | Document Code | Document Description                                                                                  | Document Category | Page Count | PDF                      |
|----------------|---------------|-------------------------------------------------------------------------------------------------------|-------------------|------------|--------------------------|
| 12-22-2006     | IRFND         | <a href="#">Processed Request for Refund</a>                                                          | PROSECUTION       | 2          | <input type="checkbox"/> |
| 11-22-2006     | ISSUE.NTF     | <a href="#">Issue Notification</a>                                                                    | PROSECUTION       | 1          | <input type="checkbox"/> |
| 11-02-2006     | IFEE          | <a href="#">Issue Fee Payment (PTO-85B)</a>                                                           | PROSECUTION       | 2          | <input type="checkbox"/> |
| 08-10-2006     | NOA           | <a href="#">Notice of Allowance and Fees Due (PTOL-85)</a>                                            | PROSECUTION       | 3          | <input type="checkbox"/> |
| 08-10-2006     | NOA           | <a href="#">Notice of Allowance and Fees Due (PTOL-85)</a>                                            | PROSECUTION       | 3          | <input type="checkbox"/> |
| 08-10-2006     | 1449          | <a href="#">List of References cited by applicant and considered by examiner</a>                      | PROSECUTION       | 1          | <input type="checkbox"/> |
| 08-10-2006     | IIFW          | <a href="#">Issue Information including classification, examiner, name, claim, renumbering, etc.</a>  | PROSECUTION       | 1          | <input type="checkbox"/> |
| 08-10-2006     | BIB           | <a href="#">Bibliographic Data Sheet</a>                                                              | PROSECUTION       | 1          | <input type="checkbox"/> |
| 08-10-2006     | FWCLM         | <a href="#">Index of Claims</a>                                                                       | PROSECUTION       | 1          | <input type="checkbox"/> |
| 08-10-2006     | SRFW          | <a href="#">Search information including classification, databases and other search related notes</a> | PROSECUTION       | 1          | <input type="checkbox"/> |
| 07-25-2006     | SRNT          | <a href="#">Examiner's search strategy and results</a>                                                | PROSECUTION       | 2          | <input type="checkbox"/> |
| 06-19-2006     | A...          | <a href="#">Amendment/Req. Reconsideration-After Non-Final Reject</a>                                 | PROSECUTION       | 1          | <input type="checkbox"/> |
| 06-19-2006     | CLM           | <a href="#">Claims</a>                                                                                | PROSECUTION       | 20         | <input type="checkbox"/> |
| 06-19-2006     | REM           | <a href="#">Applicant Arguments/Remarks Made in an Amendment</a>                                      | PROSECUTION       | 3          | <input type="checkbox"/> |
| 06-19-2006     | WFEE          | <a href="#">Fee Worksheet (SB06)</a>                                                                  | PROSECUTION       | 1          | <input type="checkbox"/> |
| 05-17-2006     | NTC.A.NONCPL  | <a href="#">Notice to the applicant regarding a non-compliant or non-responsive amendment</a>         | PROSECUTION       | 2          | <input type="checkbox"/> |
| 05-09-2006     | A.I.          | <a href="#">Informal or Non-Responsive Amendment</a>                                                  | PROSECUTION       | 2          | <input type="checkbox"/> |
| 05-09-2006     | CLM.NE        | <a href="#">Claim-Amendment Not Entered</a>                                                           | PROSECUTION       | 19         | <input type="checkbox"/> |
| 05-09-2006     | SPEC          | <a href="#">Specification</a>                                                                         | PROSECUTION       | 12         | <input type="checkbox"/> |
| 05-09-2006     | REM           | <a href="#">Applicant Arguments/Remarks Made in an Amendment</a>                                      | PROSECUTION       | 13         | <input type="checkbox"/> |
| 05-09-2006     | LET.          | <a href="#">Miscellaneous Incoming Letter</a>                                                         | PROSECUTION       | 1          | <input type="checkbox"/> |
| 05-09-2006     | XT/           | <a href="#">Extension of Time</a>                                                                     | PROSECUTION       | 3          | <input type="checkbox"/> |
| 05-09-2006     | IDS           | <a href="#">Information Disclosure Statement (IDS) Form (SB08)</a>                                    | PROSECUTION       | 2          | <input type="checkbox"/> |
| 05-09-2006     | FOR           | <a href="#">Foreign Reference</a>                                                                     | PRIOR ART         | 17         | <input type="checkbox"/> |
| 05-09-2006     | WFEE          | <a href="#">Fee Worksheet (SB06)</a>                                                                  | PROSECUTION       | 2          | <input type="checkbox"/> |
| 04-14-2006     | XT/           | <a href="#">Extension of Time</a>                                                                     | PROSECUTION       | 2          | <input type="checkbox"/> |
| 01-09-2006     | XT/           | <a href="#">Extension of Time</a>                                                                     | PROSECUTION       | 2          | <input type="checkbox"/> |
| 11-10-2005     | CTNF          | <a href="#">Non-Final Rejection</a>                                                                   | PROSECUTION       | 6          | <input type="checkbox"/> |
| 11 10 2005     | 892           | <a href="#">List of references cited by examiner</a>                                                  | PRIOR ART         | 1          | <input type="checkbox"/> |

Patent eBusiness

- [Electronic Filing](#)
- [Patent Application Information \(PAIR\)](#)
- [Patent Ownership](#)
- [Fees](#)
- [Supplemental Resources & Support](#)

Patent Information

- [Patent Guidance and General Info](#)
- [Codes, Rules & Manuals](#)
- [Employee & Office Directories](#)
- [Resources & Public Notices](#)

Patent Searches

- [Patent Official Gazette](#)
- [Search Patents & Applications](#)
- [Search Biological Sequences](#)
- [Copies, Products & Services](#)

Other

- [Copyrights](#)
- [Trademarks](#)
- [Policy & Law](#)
- [Reports](#)

Patent Application Information Retr

10/965,638 **POCKET**

Select New Case Application Data Transactio History

This application is officially maintai and click Start Download.

Available Documents

| Mail Room Date | Docur     |
|----------------|-----------|
| 12-22-2006     | IRFND     |
| 11-22-2006     | ISSUE.NTR |
| 11-02-2006     | IFEE      |
| 08-10-2006     | NOA       |
| 08-10-2006     | NOA       |
| 08-10-2006     | 1449      |
| 08-10-2006     | IIFW      |
| 08-10-2006     | BIB       |
| 08-10-2006     | FWCLM     |
| 08-10-2006     | SRFW      |
| 07-25-2006     | SRNT      |
| 06-19-2006     | A...      |
| 06-19-2006     | CLM       |
| 06-19-2006     | REM       |
| 06-19-2006     | WFEE      |
| 05-17-2006     | NTC.A.NOM |
| 05-09-2006     | A.I.      |
| 05-09-2006     | CLM.NE    |
| 05-09-2006     | SPEC      |
| 05-09-2006     | REM       |
| 05-09-2006     | LET.      |
| 05-09-2006     | XT/       |
| 05-09-2006     | IDS       |
| 05-09-2006     | FOR       |
| 05-09-2006     | WFEE      |
| 04-14-2006     | XT/       |
| 01-09-2006     | XT/       |
| 11-10-2005     | CTNF      |
| 11-10-2005     | 802       |

1. The disclosure is objected to because of the following informalities: The specification is objected to because, under the heading of Summary of the Invention, the applicant is describing the device based upon reference to the claimed subject matter, e.g. on page 4, the specification states, "The problem of the invention is resolved by the features defined in the characterizing clause of claim 1". This is not only objectionable, but considering that the content, scope and/or numbering of the claims may change during the prosecution, a description of the device based upon the claims, at the close of prosecution, may be different from that originally filed.

Appropriate correction is required.

**Claim Rejections - 35 USC § 102**

2. The following is a quotation of the appropriate paragraphs of 35 U.S.C. 102 that form the basis for the rejections under this section made in this Office action:

A person shall be entitled to a patent unless –

(e) the invention was described in (1) an application for patent, published under section 122(b), by another filed in the United States before the invention by the applicant for patent or (2) a patent granted on an application for patent by another filed in the United States before the invention by the applicant for patent, except that an international application filed under the treaty defined in section 351(a) shall have the effects for purposes of this subsection of an application filed in the United States only if the international application designated the United States and was published under Article 21(2) of such treaty in the English language.

3. Claims 1, 3, 5, 11-16, 18, 38, 40, and 41 are rejected under 35 U.S.C. 102(e) as being clearly anticipated by Yu (US 2004/0080989 A1).

4. Claim 116 is rejected under 35 U.S.C. 102(e) as being anticipated by Rivera (6,675,419).

Smart search

Quick search

**Advanced search**

Number search

Classification search

**Quick help** —

- [How many search terms can I enter per field?](#)
- [How do I enter words from the title or abstract?](#)
- [How do I enter words from the description or claims?](#)
- [Can I use truncation/wildcards?](#)
- [How do I enter publication, application, priority and NPL reference numbers?](#)
- [What is the difference between the IPC and the ECLA?](#)
- [What formats can I use for the publication date?](#)
- [How do I enter a date range for a publication date search?](#)

**Related links** +

## Advanced search

Select the collection you want to search in

Worldwide - collection of published applications from 90+ countries

Enter your search terms - CTRL-ENTER expands the field you are in

Enter keywords in English

Title:  plastic and bicycle

Title or abstract:  hair

Enter numbers with or without country code

Publication number:  WO2008014520

EP0957704

Application number:  DE19971031696

Priority number:  WO1995US15925

Enter one or more dates or date ranges

Publication date:  yyyyymmdd

Enter name of one or more persons/organisations

Applicant(s):  Institut Pasteur

Inventor(s):  Smith

Enter one or more classification symbols

Euro Classification (ECLA):  F03G7/10

International Patent Classification (IPC):  H03M1/12

Clear

Search

Links diversos para citações, processos integrais, publicações PDF, legal status, famílias de patentes, etc.

[About Espacenet](#) [Other EPO online services](#) ▾

[Search](#) [Result list](#) [★ My patents list \(0\)](#) [Queries](#) [Settings](#)

[Refine search](#) → [Results](#) → EP0957704 (A2)

EP0957704 (A2)

**Bibliographic data**

Description

Claims

Mosaics

Original document

Cited documents

Citing documents

INPADOC legal status

INPADOC patent family

**Quick help**

- [What does A1, A2, A3 and B stand for after a European publication number?](#)
- [What happens if I click on "In my patents list"?](#)
- [What happens if I click on the "EP Register" button?](#)
- [Why are some sidebar options deactivated for certain documents?](#)
- [How can I bookmark this page?](#)
- [Why does a list of documents with the heading "Also published as" sometimes appear, and what are these documents?](#)
- [Why do I sometimes find the abstract of a corresponding document?](#)
- [What happens if I click on the red "patent translate" button?](#)

**Bibliographic data: EP0957704 (A2) — 1999-11-24**

★ In my patents list    ↗ EP Register    → Report data error

 Print

**PLATE-SHAPED HOLDER HOUSING FOR DAILY USE AND/OR CONSUMER ARTICLES**

**Page bookmark**    [EP0957704 \(A2\) - PLATE-SHAPED HOLDER HOUSING FOR DAILY USE AND/OR CONSUMER ARTICLES](#)

**Inventor(s):**    PAINSITH HERMANN [AT] ±

**Applicant(s):**    VICTORINOX AG [CH]; PAINSITH HERMANN [AT] ±

**Classification:**    - international: [A45C11/00](#); [A45D29/20](#); [B29C65/02](#); [C12N15/53](#); [A45C11/18](#); [A45C11/32](#); (IPC1-7): [A45C11/00](#); [A45D29/20](#)

- Euro:    [A45C11/00](#); [A45D29/20](#)

**Application number:**    EP19960939748 19961202

**Priority number(s):**    WO1996AT00238 19961202; AT19950001961 19951130

**Also published as:**    [EP0957704 \(B1\)](#)    [EP0957704 \(B2\)](#)    [WO9719856 \(A2\)](#)    [WO9719856 \(A3\)](#)    [US2001047946 \(A1\)](#)  
 → [more](#)

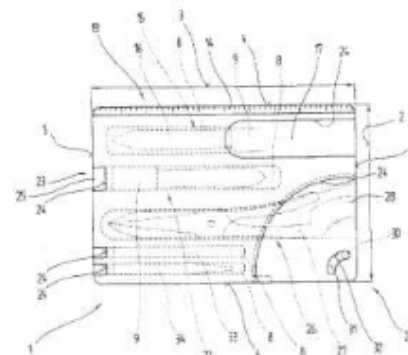
**Abstract not available for EP0957704 (A2)**

**Abstract of corresponding document: WO9719856 (A2)**

Translate this text into


 powered by EPO and Google

The invention concerns a plate-shaped metal or plastics housing (1) with at least one internal chamber (8) for holding at least one object. The chamber (8) is delimited by a base plate (6) and at least at given points by a cover plate (7) of the housing (1), the cover plate (7) being parallel to the base plate (6). The housing (1) comprises a plurality of chambers (8) which are disposed adjacent one another in a plane extending parallel to the base plate (6) and/or cover plate (7) and are at least partially separate from one another. The chambers (8) are designed to hold objects such as daily use (9) and/or consumer articles and are accessible from the exterior via openings (23) which are disposed in at least one of the transverse side surfaces (5) and/or longitudinal side surfaces (4) which preferably extend at right-angles to the base plate (6) and/or cover plate (7).





Acesso a publicações integrais de diversos países, incluindo publicações de pedidos BR

EP0957704 (B2)

Bibliographic data

Description

Claims

Mosaics

Original document

Cited documents

Citing documents

INPADOC legal status

INPADOC patent family

Quick help

→ [What happens if I click on "In my patents list"?](#)

→ [What happens if I click on the "EP Register" button?](#)

→ [How can I maximise the page view?](#)

→ [How can I download documents?](#)

## Original document EP0957704 (B2) — 2006-07-05

★ In my patents list → EP Register → Report data error

Print

### PLATE-SHAPED HOLDER HOUSING FOR DAILY USE AND/OR CONSUMER ARTICLES

Page 1/54 Bibliography

Maximise

Download

(19)  Europäisches Patentamt  
European Patent Office  
Office européen des brevets



(11) EP 0 957 704 B2

#### (12) NEUE EUROPÄISCHE PATENTSCHRIFT

(45) Veröffentlichungstag und Bekanntmachung des  
Hinweises auf die Entscheidung über den Einspruch:  
05.07.2006 Patentblatt 2006/27

(51) Int Cl.:  
A45C 11/00 (2006.01) A45D 29/20 (2006.01)

(45) Hinweis auf die Patenterteilung:  
08.10.2003 Patentblatt 2003/41

(86) Internationale Anmeldenummer:  
PCT/AT1996/000238

(21) Anmeldenummer: 96939748.8

(87) Internationale Veröffentlichungsnummer:  
WO 1997/019856 (05.06.1997 Gazette 1997/24)

(22) Anmeldetag: 02.12.1996

#### (54) PLATTENFÖRMIGES AUFNAHMEGEHÄUSE FÜR GEBRAUCHS- UND/ODER VERBRAUCHSGEGENSTÄNDE

PLATE-SHAPED HOLDER HOUSING FOR DAILY USE AND/OR CONSUMER ARTICLES

ETUI PLAT POUR OBJETS D'UTILISATION COURANTE OU DE CONSOMMATION

(84) Benannte Vertragsstaaten:  
AT CH DE ES FR GB IT LI PT

(72) Erfinder: PAINSITH, Hermann  
A-9020 Klagenfurt (AT)

(30) Priorität: 30.11.1995 AT 196195

(74) Vertreter: Secklehner, Günter  
Rechtsanwalt,  
Pyhrnstrasse 1  
8940 Liezen (AT)

(43) Veröffentlichungstag der Anmeldung:  
24.11.1999 Patentblatt 1999/47

(60) Teilanmeldung:  
02028246.3 / 1 293 144

(56) Entgegenhaltungen:  
WO-A-93/22948 WO-A-94/29083  
DE-A-3 843 303 DE-C-2 416 752  
DE-C-3 827 536 DE-U-9 316 522  
FR-A-739 682 FR-A-2 656 779  
GB-A-2 456 622

(73) Patentinhaber:  
• VICTORINOX AG  
5290 Hock (CH)

Informações resumidas sobre andamento processual em diversos países

About Espacenet Other EPO online services ▾

Search Result list **★ My patents list (0)** Query history Settings

Refine search → Results → EP0957704 (A2)

- EP0957704 (A2)
- Bibliographic data
- Description
- Claims
- Mosaics
- Original document
- Cited documents
- Citing documents
- INPADOC legal status**
- INPADOC patent family

Quick help ▾

- [What happens if I click on "In my patents list"?](#)
- [What happens if I click on the "EP Register" button?](#)
- [What does "legal status" mean?](#)
- [Why is the legal status not always available?](#)
- [How might this information be useful to me?](#)
- [How reliable is this data?](#)
- [What are legal status \(PRS\) codes?](#)

## INPADOC legal status: 0957704 (A2) — 1999-11-24

★ In my patents list → Register → Report data error Print

### PLATE-SHAPED HOLDER HOUSING FOR DAILY USE AND/OR CONSUMER ARTICLES

The EPO does not accept any responsibility for the accuracy of data and information originating from other authorities than the EPO; in particular, the EPO does not guarantee that they are complete, up-to-date or fit for specific purposes.

Legal status of EP0957704 (A2) 1999-11-24; EP0957704 (B1) 2003-10-08; EP0957704 (B2) 2006-07-05:

|                       |                                  |            |                       |
|-----------------------|----------------------------------|------------|-----------------------|
| EP                    | F                                | 96939748 A | (Patent of invention) |
| PRS Date :            | 1999/11/24                       |            |                       |
| PRS Code :            | AK                               |            |                       |
| Code Expl.:           | + DESIGNATED CONTRACTING STATES: |            |                       |
| KD OF CORRESP. PAT. : | A2                               |            |                       |
| DESIGNATED COUNTR. :  | AT CH DE ES FR GB IT LI PT       |            |                       |
| PRS Date :            | 1999/11/24                       |            |                       |
| PRS Code :            | 17P                              |            |                       |
| Code Expl.:           | + REQUEST FOR EXAMINATION FILED  |            |                       |
| EFFECTIVE DATE :      | 19980828                         |            |                       |
| PRS Date :            | 2001/10/04                       |            |                       |
| PRS Code :            | 17Q                              |            |                       |
| Code Expl.:           | + FIRST EXAMINATION REPORT       |            |                       |
| EFFECTIVE DATE :      | 20010816                         |            |                       |
| PRS Date :            | 2003/10/08                       |            |                       |
| PRS Code :            | AK                               |            |                       |
| Code Expl.:           | + DESIGNATED CONTRACTING STATES: |            |                       |
| KD OF CORRESP. PAT. : | B1                               |            |                       |
| DESIGNATED COUNTR. :  | AT CH DE ES FR GB IT LI PT       |            |                       |
| PRS Date :            | 2003/10/08                       |            |                       |

KD OF CORRESP. PAT. : T3

PRS Date : 2004/07/23

PRS Code : ET

Code Expl.: + FR: TRANSLATION FILED

PRS Date : 2004/09/01

PRS Code : 26

Code Expl.: - OPPOSITION FILED

OPPONENT NAME : VEREINIGTE STAHLWARENFABRIKEN GEBR. RICHARTZ + SOE

EFFECTIVE DATE : 20040708

PRS Date : 2006/07/05

PRS Code : 27A

Code Expl.: MAINTAINED AS AMENDED

EFFECTIVE DATE : 20060705

PRS Date : 2006/07/05

PRS Code : AK

Code Expl.: + DESIGNATED CONTRACTING STATES:

KD OF CORRESP. PAT. : B2

DESIGNATED COUNTR. : AT CH DE ES FR GB IT LI PT

PRS Date : 2006/07/31

PRS Code : REG CH AEN

Code Expl.: MODIFICATION OF THE SCOPE OF THE PATENT

FURTHER INFORMATION : AUFRECHTERHALTUNG DES PATENTES IN GEÄNDERTER FORM

PRS Date : 2006/11/01

PRS Code : GBTA

Code Expl.: + GB: TRANSLATION OF AMENDED EP PATENT FILED (GB SECTION 77(6)(B)/1977)

PRS Date : 2007/02/16

PRS Code : ET3

Code Expl.: + FR: TRANSLATION FILED \*\* DECISION CONCERNING OPPOSITION

PRS Date : 2007/03/16

PRS Code : REG ES DC2A

Code Expl.: PATENT MODIFIED

KD OF CORRESP. PAT. : T5



Histórico e acesso integral a todas as comunicações entre o EPO e os titulares e, eventualmente, Oponentes

[← About European Patent Register](#) [Other EPO online services](#) ▾

[Login](#)

[Smart search](#) [Quick search](#) [Advanced search](#) [Help](#)

EP0957704

**About this file**

[Legal status](#)

[Event history](#)

[Citations](#)

[Patent family](#)

[All documents](#)

**About this file: EP0957704**

[Refine search](#) [ST38](#) [Show history](#) [Espacenet](#) [Submit observations](#) [Report error](#) [Print](#)

**EP0957704 - PLAIN SHAPED HOLDER HOUSING FOR DAILY USE AND/OR CONSUMER ARTICLES** [\[ Right-click to bookmark this link \]](#)

**Status** Patent maintained as amended  
 Database last updated on 23.11.2012  
**Most recent event** i 04.01.2008 Lapse of the patent in a contracting state published on 06.02.2008 [2008/06]

**Quick help** ▾

- [What happens if I click on the "XML" or "ST38" buttons?](#)
- [What kind of information can be found if I click on the "Show history" button?](#)
- [What kind of information can be found under "Status"?](#)
- [What do the digits in square brackets refer to?](#)
- [What does N/P stand for?](#)
- [Why are the publication dates of the European and international applications identical?](#)
- [What does the letter in square brackets stand for in the "Documents cited" part?](#)
- [Is it possible to navigate in the result list?](#)

[Maintenance news](#) +

[News flashes](#) +

[Related links](#) +

**Applicant(s)** For all designated states  
 VICTORINOX AG  
 Schmiedgasse 57  
 8438 Ibach / CH  
 For all designated states  
 Painsith, Hermann  
 Wulfengasse 6  
 9020 Klagenfurt / AT  
 [1999/47]

**Inventor(s)** 01 / PAINSITH, Hermann  
 Wulfengasse 6  
 A-9020 Klagenfurt / AT  
 [1999/47]

**Representative(s)** Secklehner, Günter  
 Rechtsanwalt, Pyhrnstrasse 1  
 8940 Liezen / AT  
 [N/P]

**Application number, filing date** 96939748.8 02.12.1996  
 [1999/47]

**Priority number, date** WO1996AT00238  
 AT19950001961 30.11.1995 Original published format: TA 196195  
 [1999/47]

**Filing language** DE

**Procedural language** DE

**Publication** **Type :** A2 Application without search report

**No. :** WO9719856

**Date :** 05.06.1997

Histórico e acesso integral a todas as comunicações entre o EPO e os titulares e, eventualmente, Oponentes

- EP0957704
- About this file
- Legal status
- Event history
- Citations
- Patent family
- All documents**

**Quick help** --

- [Is it possible to download one or more of the documents?](#)
- [Is it possible to print a list of all the documents?](#)
- [Can I sort the list of documents?](#)
- [Is it possible to open a the document?](#)
- [Can I open multiple documents in separate windows?](#)
- [Is it possible to print documents?](#)

**Maintenance news** +

**News flashes** +

**Related links** +

## All documents: EP0957704

Refine search
  Select documents
  Espacenet
  Submit observations
  Report error
  Print

| <input type="checkbox"/> | Date       | Document type                                                                                | Procedure  | Number of pages |
|--------------------------|------------|----------------------------------------------------------------------------------------------|------------|-----------------|
| <input type="checkbox"/> | 17.07.2007 | <a href="#">Termination of the opposition proceedings with maintenance of patent</a>         | Opposition | 2               |
| <input type="checkbox"/> | 08.06.2006 | <a href="#">Decision to maintain the European patent in amended form</a>                     | Opposition | 1               |
| <input type="checkbox"/> | 08.06.2006 | <a href="#">Decision to maintain the European patent in amended form</a>                     | Opposition | 1               |
| <input type="checkbox"/> | 23.05.2006 | <a href="#">English translation of the claims</a>                                            | Opposition | 4               |
| <input type="checkbox"/> | 23.05.2006 | <a href="#">French translation of claims</a>                                                 | Opposition | 5               |
| <input type="checkbox"/> | 23.05.2006 | <a href="#">Letter regarding the opposition procedure (no time limit)</a>                    | Opposition | 2               |
| <input type="checkbox"/> | 11.04.2006 | <a href="#">Communication of bibliographic data</a>                                          | Opposition | 1               |
| <input type="checkbox"/> | 11.04.2006 | <a href="#">Communication to opponent concerning maintenance</a>                             | Opposition | 2               |
| <input type="checkbox"/> | 11.04.2006 | <a href="#">Communication with request to pay printing fees and file translations</a>        | Opposition | 2               |
| <input type="checkbox"/> | 07.04.2006 | <a href="#">Maintenance of the patent with the documents specified in the final decision</a> | Opposition | 1               |
| <input type="checkbox"/> | 07.01.2006 | <a href="#">Acknowledgement of a document</a>                                                | Opposition | 1               |
| <input type="checkbox"/> | 29.12.2005 | <a href="#">Advice of delivery</a>                                                           | Opposition | 1               |
| <input type="checkbox"/> | 23.12.2005 | <a href="#">Druckexemplar</a>                                                                | Opposition | 56              |
| <input type="checkbox"/> | 23.12.2005 | <a href="#">Grounds for the decision (Annex) - opposition</a>                                | Opposition | 8               |
| <input type="checkbox"/> | 23.12.2005 | <a href="#">Interlocutory decision in opposition proceedings</a>                             | Opposition | 2               |
| <input type="checkbox"/> | 23.12.2005 | <a href="#">Internal form - Opposition/addressees</a>                                        | Opposition | 1               |
| <input type="checkbox"/> | 10.12.2005 | <a href="#">Description</a>                                                                  | Opposition | 7               |
| <input type="checkbox"/> | 10.12.2005 | <a href="#">Description</a>                                                                  | Opposition | 7               |
| <input type="checkbox"/> | 10.12.2005 | <a href="#">Reply to an examination report in opposition proceedings</a>                     | Opposition | 2               |
| <input type="checkbox"/> | 17.11.2005 | <a href="#">Annex to the communication - opposition</a>                                      | Opposition | 1               |

About Espacenet Other EPO online services ▾

Search Result list **★ My patents list (0)** Query history Settings

Refine search → Results → EP0957704 (A2) → Family page 1

EP0957704 (A2)

Bibliographic data  
 Description  
 Claims  
 Mosaics  
 Original document  
 Cited documents  
 Citing documents  
 INPADOC legal status

**INPADOC patent family**

Quick help

- [Can I export this list?](#)
- [What happens if I click on "Download covers"?](#)
- [Can I sort the list?](#)
- [What happens if I click on the star icon?](#)
- [What is a patent family?](#)
- [What is an INPADOC patent family?](#)
- [Are all the documents in an INPADOC family equivalents?](#)
- [Why is the same document published several times in the same country?](#)

Pesquisa a documentos  
 "correspondentes" e  
 outros membros de  
 família de patente  
 "expandida" do  
 INPADOC

**Family list: EP0957704 (A2) 1999-11-24**

Select all  Compact  Sort (CSV | XLS)

17 application(s) for EP0957704 (A2)

▸  
 page 1

Sort by  Sort order

**1. PLATE-SHAPED HOLDER HOUSING FOR DAILY USE AND/OR CONSUMER ARTICLES**

★ Inventor: PAINSITH HERMANN [AT]    Applicant: VICTORINOX AG [CH] PAINSITH HERMANN [AT]    EC: [A45C11/00](#) [A45D29/20](#)    IPC: A45C11/00 A45D29/20 B29C85/02 (+5)    Publication info: AT251398 (T) 2003-10-15    Priority date: 1995-11-30

**2. PLATE-SHAPED HOLDER HOUSING FOR DAILY USE AND/OR CONSUMER ARTICLES**

★ Inventor: PAINSITH HERMANN [AT]    Applicant: PAINSITH HERMANN [AT] VICTORINOX AG [CH]    EC: [A45C11/00](#) [A45D29/20](#)    IPC: A45C11/00 A45D29/20 B29C85/02 (+5)    Publication info: AT277538 (T) 2004-10-15    Priority date: 1995-11-30

**3. PLATE-SHAPED HOLDER HOUSING FOR DAILY USE AND/OR CONSUMER ARTICLES**

★ Inventor:    Applicant: PAINSITH HERMANN DIPL ING [AT]    EC: [A45C11/00](#) [A45D29/20](#)    IPC: A45C11/00 A45D29/20 B29C85/02 (+4)    Publication info: ATA198195 (A) 1998-02-15 AT404237 (B) 1998-09-25    Priority date: 1995-11-30

**4. Plate-shaped holder housing for daily use and/or consumer articles**

★ Inventor: PAINSITH HERMANN    Applicant: HERMANN PAINSITH VICTORINOX AG    EC: [A45C11/00](#) [A45D29/20](#)    IPC: A45C11/00 A45D29/20 B29C85/02 (+4)    Publication info: AU7885398 (A) 1997-08-19    Priority date: 1995-11-30

**5. Plate-shaped holder housing for daily use and/or consumer articles**

★ Inventor: PAINSITH HERMANN [CH]    Applicant: VICTORINOX AG [CH]    EC: [A45C11/00](#) [A45D29/20](#)    IPC: A45C11/00 A45D29/20 B29C85/02 (+5)    Publication info: CN1207853 (A) 1999-02-10 CN1161059 (C) 2004-08-11    Priority date: 1995-11-30

**6. PLATE-SHAPED HOLDER HOUSING FOR DAILY USE AND/OR CONSUMER ARTICLES**

★ Inventor:    Applicant: VICTORINOX AG IBACH [CH] PAINSITH HERMANN [AT]    EC: [A45C11/00](#) [A45D29/20](#)    IPC: A45C11/00 A45D29/20    Publication info: DE29624203 (U1) 2001-04-26    Priority date: 1995-11-30

B29C65/02 EP1293144 (A3)  
(+5) 2003-03-28  
EP1293144 (B1)  
2004-09-29

9. PLATE-SHAPED HOLDER HOUSING FOR DAILY USE AND/OR CONSUMER ARTICLES

|                                         |                                                 |                                             |                                                     |                                                                                   |                              |
|-----------------------------------------|-------------------------------------------------|---------------------------------------------|-----------------------------------------------------|-----------------------------------------------------------------------------------|------------------------------|
| ★ Inventor:<br>PAINSITH HERMANN<br>[AT] | Applicant:<br>VICTORINOX AG<br>PAINSITH HERMANN | EC:<br><u>A45C11/00</u><br><u>A45D29/20</u> | IPC:<br>A45C11/00<br>A45D29/20<br>B29C65/02<br>(+5) | Publication info:<br>ES2208767 (T3)<br>2004-06-16<br>ES2208767 (T5)<br>2007-03-16 | Priority date:<br>1995-11-30 |
|-----------------------------------------|-------------------------------------------------|---------------------------------------------|-----------------------------------------------------|-----------------------------------------------------------------------------------|------------------------------|

10. PLATE-SHAPED HOLDER HOUSING FOR DAILY USE AND/OR CONSUMER ARTICLES

|                                         |                                                 |                                             |                                                     |                                                   |                              |
|-----------------------------------------|-------------------------------------------------|---------------------------------------------|-----------------------------------------------------|---------------------------------------------------|------------------------------|
| ★ Inventor:<br>PAINSITH HERMANN<br>[AT] | Applicant:<br>PAINSITH HERMANN<br>VICTORINOX AG | EC:<br><u>A45C11/00</u><br><u>A45D29/20</u> | IPC:<br>A45C11/00<br>A45D29/20<br>B29C65/02<br>(+5) | Publication info:<br>ES2230442 (T3)<br>2005-05-01 | Priority date:<br>1995-11-30 |
|-----------------------------------------|-------------------------------------------------|---------------------------------------------|-----------------------------------------------------|---------------------------------------------------|------------------------------|

11. Card-shaped storage case for articles of daily use and/or consumer articles.

|                                 |                                                      |                                             |                                                     |                                                   |                              |
|---------------------------------|------------------------------------------------------|---------------------------------------------|-----------------------------------------------------|---------------------------------------------------|------------------------------|
| ★ Inventor:<br>PAINSITH HERMANN | Applicant:<br>VICTORINOX AG [CH]<br>PAINSITH HERMANN | EC:<br><u>A45C11/00</u><br><u>A45D29/20</u> | IPC:<br>A45C11/00<br>A45D29/20<br>B29C65/02<br>(+5) | Publication info:<br>HK1017592 (A1)<br>2005-02-25 | Priority date:<br>1995-11-30 |
|---------------------------------|------------------------------------------------------|---------------------------------------------|-----------------------------------------------------|---------------------------------------------------|------------------------------|

12. PLATE-SHAPED HOLDER HOUSING FOR DAILY USE AND/OR CONSUMER ARTICLES

|             |            |                                             |                                                     |                                                                                     |                              |
|-------------|------------|---------------------------------------------|-----------------------------------------------------|-------------------------------------------------------------------------------------|------------------------------|
| ★ Inventor: | Applicant: | EC:<br><u>A45C11/00</u><br><u>A45D29/20</u> | IPC:<br>A45C11/00<br>A45D29/20<br>B29C65/02<br>(+4) | Publication info:<br>JP2000501003 (A)<br>2000-02-02<br>JP4098360 (B2)<br>2008-06-11 | Priority date:<br>1995-11-30 |
|-------------|------------|---------------------------------------------|-----------------------------------------------------|-------------------------------------------------------------------------------------|------------------------------|

13. Plate-shaped holder housing for daily use and/or consumer articles

|                                         |                                  |                                             |                                                     |                                                  |                              |
|-----------------------------------------|----------------------------------|---------------------------------------------|-----------------------------------------------------|--------------------------------------------------|------------------------------|
| ★ Inventor:<br>PAINSITH HERMANN<br>[AT] | Applicant:<br>VICTORINOX AG [CH] | EC:<br><u>A45C11/00</u><br><u>A45D29/20</u> | IPC:<br>A45C11/00<br>A45D29/20<br>B29C65/02<br>(+4) | Publication info:<br>US6044967 (A)<br>2000-04-04 | Priority date:<br>1995-11-30 |
|-----------------------------------------|----------------------------------|---------------------------------------------|-----------------------------------------------------|--------------------------------------------------|------------------------------|

14. Card-shaped storage case for articles of daily use and/or consumer articles

|                                         |                                  |                                             |                                                     |                                                   |                              |
|-----------------------------------------|----------------------------------|---------------------------------------------|-----------------------------------------------------|---------------------------------------------------|------------------------------|
| ★ Inventor:<br>PAINSITH HERMANN<br>[AT] | Applicant:<br>VICTORINOX AG [US] | EC:<br><u>A45C11/00</u><br><u>A45D29/20</u> | IPC:<br>A45C11/00<br>A45D29/20<br>B29C65/02<br>(+4) | Publication info:<br>US6257405 (B1)<br>2001-07-10 | Priority date:<br>1995-11-30 |
|-----------------------------------------|----------------------------------|---------------------------------------------|-----------------------------------------------------|---------------------------------------------------|------------------------------|

15. Card-shaped storage case for articles of daily use and/or consumer articles

|                                         |                                  |                                             |                                                     |                                                                                      |                              |
|-----------------------------------------|----------------------------------|---------------------------------------------|-----------------------------------------------------|--------------------------------------------------------------------------------------|------------------------------|
| ★ Inventor:<br>PAINSITH HERMANN<br>[AT] | Applicant:<br>VICTORINOX AG [US] | EC:<br><u>A45C11/00</u><br><u>A45D29/20</u> | IPC:<br>A45C11/00<br>A45D29/20<br>B29C65/02<br>(+8) | Publication info:<br>US2001047946 (A1)<br>2001-12-08<br>US6527112 (B2)<br>2003-03-04 | Priority date:<br>1995-11-30 |
|-----------------------------------------|----------------------------------|---------------------------------------------|-----------------------------------------------------|--------------------------------------------------------------------------------------|------------------------------|

Acesso a publicações integrais de diversos países, incluindo publicações de pedidos BR

[About Espacenet](#) [Other EPO online services](#)

Search Result list **★ My patents list (0)** Query history

[EP0957704 \(B2\)](#) → [Family page 1](#) → [US8044967 \(A\)](#)

- US6044967 (A)
- Bibliographic data
- Description
- Claims
- Mosaics
- Original document**
- Cited documents
- Citing documents
- INPADOC legal status
- INPADOC patent family

Quick help

- [What happens if I click on "In my patents list"?](#)
- [What happens if I click on the "EP Register" button?](#)
- [How can I maximise the page view?](#)
- [How can I download documents?](#)

**Original document US6044967 (A) — 2000-04-04**

★ In my patents list Previous 13 / 17 Next EP Register Report data error Print

**Plate-shaped holder housing for daily use and/or consumer articles**

Page 1/43 Abstract Bibliography Maximise Download



US006044967A

**United States Patent** [19] [11] **Patent Number: 6,044,967**  
**Painsith** [45] **Date of Patent: Apr. 4, 2000**

**[54] PLATE-SHAPED HOLDER HOUSING FOR DAILY USE AND/OR CONSUMER ARTICLES**

[75] Inventor: **Hermann Painsith**, Klagenfurt, Austria  
 [73] Assignee: **Victorinox AG**, Ibach, Switzerland  
 [21] Appl. No.: **09/077,482**  
 [22] PCT Filed: **Dec. 2, 1996**  
 [86] PCT No.: **PCT/AT96/00238**  
 § 371 Date: **May 29, 1998**  
 § 102(c) Date: **May 29, 1998**  
 [87] PCT Pub. No.: **WO97/19856**  
 PCT Pub. Date: **Jun. 5, 1997**

**[30] Foreign Application Priority Data**  
 Nov. 30, 1995 [AT] Austria ..... 1961/95  
 [51] **Int. Cl.<sup>7</sup>** ..... **B65D 69/00**  
 [52] **U.S. CL.** ..... **206/234; 206/37; 206/349**  
 [58] **Field of Search** ..... **206/216, 234, 206/38, 38.1, 235-241, 349, 37, 37.1, 37.4, 37.6**

**[56] References Cited**  
**U.S. PATENT DOCUMENTS**  
 5,467,871 11/1995 DeField ..... 206/37.1  
 5,621,936 4/1997 Penaligon et al. .... 206/234

**FOREIGN PATENT DOCUMENTS**

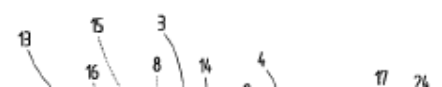
739628 1/1933 France .  
 2656799 A1 7/1991 France .  
 3843303 A1 7/1989 Germany .  
 3827536 C1 11/1989 Germany .  
 2 146 623 4/1985 United Kingdom .  
 WO94/29083  
 A2 12/1994 WIPO .

*Primary Examiner*—Paul T. Sewell  
*Assistant Examiner*—Luan K. Bui  
*Attorney, Agent, or Firm*—Alston & Bird LLP

**[57] ABSTRACT**

The invention relates to a card-shaped storage case (1) made of metal or plastic with at least one internal storage compartment (8) for at least one article, which is defined by a base plate (6) and at least in sections by a cover plate (7) of the storage case (1) running parallel to this, wherein several storage compartments (8) at least partially separate from one another are arranged in the storage case (1) in a plane running parallel to the base plate (6) and/or cover plate (7) and are constructed to receive articles in the form of articles of daily use (9) and/or consumer articles and are also accessible from the outside via storage openings (23), and the storage openings (23) are arranged in at least one of the longitudinal side faces (4) and/or transverse side faces (5) preferably running perpendicular to the base plate (6) and/or cover plate (7).

**40 Claims, 26 Drawing Sheets**



# Fontes de Informações Sobre Decisões, Jurisprudência

- EPO - Case Law and Appeals
  - <http://www.epo.org/law-practice/case-law-appeals.html>
- Blogs, Sites...
  - [www.jusbrasil.com.br](http://www.jusbrasil.com.br)
  - [www.ipwatchdog.com](http://www.ipwatchdog.com)
  - [www.patentdocs.org](http://www.patentdocs.org)
  - Etc.
- Revista da ABPI



Basic search - board of appeal decisions database

Advanced search - board of appeal decisions database

Recent decisions

Enlarged Board of Appeal

Case Law of the Boards of Appeal

Business distribution scheme

Case Law from the Contracting States to the EPC

## Case law and appeals



Print 

### See also

→ [Check the calendar of oral proceedings.](#)

Find out more about the boards of appeal - their structure, organisation and what they do.

→ [Boards of appeal](#)

Read about a proposal to give the EPO's boards of appeal organisational autonomy and a judicial function.

Organisational autonomy of the boards of appeal

→ [Standing Advisory Committee before the EPO \(SACEPO\)](#)

→ [European Round-Table on Patent Practice \(EUROTAB\)](#)

The boards of appeal and associated administrative services are integrated into the organisational structure of the EPO as Directorate-General 3. They are independent from the Office in their decisions and are bound only by the European Patent Convention (EPC).

### The boards of appeal decisions database

Comprehensive texts of each decision of the EPO boards of appeal contained in the database (since 1979). The decisions are available in the language of the proceedings (English, French or German).

- [Basic search engine](#)
- [Advanced search engine](#)
- [Recent decisions](#)

### Enlarged Board of Appeal


- [Pending referrals \(Art. 112 EPC\)](#)
- [Decisions sorted by number \(Art. 112 EPC\)](#)
- [Pending petitions for review \(Art. 112a EPC\)](#)
- [Decisions on petitions for review \(Art. 112a EPC\)](#)

### Texts related to appeal proceedings

- [Business distribution scheme](#)
- ↳ [Information from the Boards of Appeal including rules of procedure](#)

### Website updates

- 16.11.2012**  
[Enlarged Board of Appeal: new petition for review \(R 17/12\)](#)
- 8.11.2012**  
[Enlarged Board of Appeal: new decisions on petition for review \(R 20/11 and R 21/11\)](#)
- 2.10.2012**  
[Enlarged Board of Appeal: new decision on petition for review \(R 2/12\)](#)

→ [Updates archive](#) [RSS: appeals](#) 

### Case law

A substantial body of case law on the European Patent Convention has developed since the first decision of a board of appeal was handed down in 1979.

- [Case Law of the Boards of Appeal \(sixth edition 2010\)](#)
- ↳ [EPO Board of Appeal Case Law 2011 \(OJ Special edition 2012\)](#)
- ↳ [EPO Board of Appeal Case Law 2010 \(OJ Special edition 2/2011\)](#)
- ↳ [EPO Board of Appeal Case Law 2009 \(OJ Special edition 2/2010\)](#)
- [Recent decisions](#)

[email a friend](#)

[bookmark or share](#)

## HOT Items

- 02/01: The EPO's legal status file adds Slovakian data.
- 01/19: Google updates Google Scholar with legal opinion and journal search options.
- 01/11: The EPO announces addition of JP citations to DOCDB.
- 01/07: ChemAxon search platform JChem gains access to Thomson Reuters chemical IP Data Feeds including Markush Structures and patent data.
- 12/30: Online Public Access Prototype search system launched by the US National Archives.
- 12/14: Patent Lens Report fully reviewed and updated!

## WELCOME TO INTELLOGIST!

To network with our international community of patent info pros, please [create an account](#).

For a list of our current members, see our

[Click here to read the Intellogist Blog!](#)

[Follow us on Twitter!](#)

### Search System Reports

See detailed information on search systems

### Interactive Patent Coverage Map

Click on map to find patent search systems

### Quick Table Comparisons

| Delphion | Dialog | esp@cenet | PatBase |
|----------|--------|-----------|---------|
| Yes      | No     | Yes       | No      |
| No       | Yes    | No        | Yes     |

Quickly compare patent search systems

### Best Practices in Prior Art Searching

Collaborate on prior art search practices

### Resource Finder

- [abinit.org](#)
- [chemsources.com](#)
- [chemnetbase.com](#)
- [lupac.org](#)

Find prior art resources by technical field

### Please Support Our Sponsor:

SIEMENS WATER TECHNOLOGIES IS USING THOMSON INNOVATION TO DO JUST THAT.

### Legal & Technical Translations

We speak your language (and theirs)

专利 [Learn more](#)

### INTELLOGIST CONSULTING SERVICES

CUSTOMIZED EXPERT IP GUIDANCE

### Patent Analysis

Put your IP to work

[Learn more](#)



# Portal Periódicos CAPES

http://www.periodicos.capes.gov.br



## BUSCA

Buscar assunto

Buscar periódico

Buscar livro

Buscar base

## INSTITUCIONAL

Histórico

Missão e objetivos

Quem participa

Documentos

Estatísticas de uso

## ACERVO

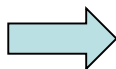
## NOTÍCIAS

## SUPORTE

Treinamentos

Materiais didáticos

Web TV



## BUSCA

Assunto

### BUSCAR ASSUNTO

Inserir termo

Enviar

Periódico

Livro

Base

Apesar do Portal realizar uma busca em qualquer idioma, sugere-se que sejam utilizados termos em inglês considerando que a literatura científica é em sua maioria publicada em inglês. Isso aumenta o número de resultados recuperados. Entretanto, nada impede que outros idiomas sejam utilizados. Busca avançada

## DESTAQUES

Science

Former head of China's genome powerhouse starts new chapter

## Notícias

### Aparência de Plutão fascina cientistas

Artigo publicado pelo periódico Nature, disponibilizado pelo Portal de Periódicos, fala sobre características surpreendentes, como o "coração de Plutão" - mancha brilhante com alta concentração de monóxido de carbono congelado

Um dos destaques na mídia especializada nas últimas semanas é a representatividade de Plutão no universo, apesar de ser considerado um



# Portal Periódicos CAPES

http://www.periodicos.capes.gov.br



Acesso à informação

Participe

Serviços

Legislação

Canais

[Ir para o conteúdo](#) [Ir para o menu](#) [Ir para a busca](#) [Ir para o rodapé](#)

[MEU ESPAÇO](#) [ACESSIBILIDADE](#) [ALTO CONTRASTE](#) [MAPA DO SITE](#)

Portal de

## Periódicos

CAPES/MEC

[Perguntas frequentes](#) | [Contato](#)

[PÁGINA INICIAL](#) > [ACERVO](#)



BUSCA

[Buscar assunto](#)

[Buscar periódico](#)

[Buscar livro](#)

[Buscar base](#)

INSTITUCIONAL

[Histórico](#)

[Missão e objetivos](#)

[Quem participa](#)

[Documentos](#)

[Estatísticas de uso](#)

**ACERVO**

[NOTÍCIAS](#)

[SUPORTE](#)

[Treinamentos](#)

[Materiais didáticos](#)

[Web TV](#)

## Acervo

O Portal de Periódicos da Capes oferece acesso a textos completos disponíveis em mais de 37 mil publicações periódicas, internacionais e nacionais, e à a diversas bases de dados que reúnem desde referências e resumos de trabalhos acadêmicos e científicos até normas técnicas, patentes, teses e dissertações dentre outros tipos de materiais, cobrindo todas as áreas do conhecimento. Inclui também uma seleção de importantes fontes de informação científica e tecnológica de acesso gratuito na web. Para verificar a disponibilidade de acesso a determinado conteúdo pelo Portal, realize uma busca pelas opções abaixo:

Áreas de conhecimento

Todas as áreas do conhecimento

Termo

Inserir Termo

Filtrar

Exibindo 1 a 10 de 259 registros

< 1 2 3 4 5 6 7 >

19.09.13  
03h09



19th Century Collections Online - NCCO (Gale)

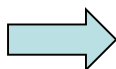
A assinatura pelo Portal de Periódicos da Nineteenth Century Collections Online da Gale/Cengage Learning pelo contrato Gale Collection Online I permite acesso gratuito a todos os bras...

27.04.04  
03h04



Abstracts in New Technology & Engineering (ANTE)

O Portal de Periódicos da CAPES pelo contrato Proquest disponibiliza a base de dados de referências e resumos Abstracts in New Technology & Engineering - ANTE. A Abstracts in New T...



# Portal Periódicos CAPES

<http://www.periodicos.capes.gov.br>

## Web of Science

Disponível desde 19.10.00

Base de dados referencial com resumos em todas as áreas do conhecimento.

A base referencial multidisciplinar, Web of Science, que está integrada à base ISI Web of Knowledge. Oferece ferramentas para análise de citações, referências, índice h, permitindo análises bibliométricas. Cobre aproximadamente 12.000 periódicos. A assinatura deste conteúdo, oferece a possibilidade de consulta a 5 coleções: Science Citation Index Expanded (SCI-EXPANDED) - com disponibilidade de acesso a registros desde 1945 até o presente; Social Sciences Citation Index (SSCI) - com disponibilidade de acesso a registros desde 1956 até o presente; Arts & Humanities Citation Index (A&HCI) - com disponibilidade de acesso a registros desde 1975 até o presente; Conference Proceedings Citation Index- Science (CPCI-S) - com disponibilidade de acesso a registros desde 1990 até o presente e Conference Proceedings Citation Index - Social Science & Humanities (CPCI-SSH) - com disponibilidade de acesso a registros desde 1990 até o presente.

<http://apps.webofknowledge.com/>



# Portal Periódicos CAPES

<http://www.periodicos.capes.gov.br>

## Derwent Innovations Index (DII)

Disponível desde 22.10.09

Base de dados de patentes nas áreas de engenharia química, elétrica, eletrônica e mecânica.

Integrada à plataforma ISI Web of Knowledge, da Thomson Reuters, a Derwent Innovations Index (DII) é uma base de dados que possui referências e resumos de patentes com links para documentos em texto completo, se disponíveis, além de referências relacionadas nas áreas de: engenharia química, elétrica, eletrônica e mecânica. O período disponível para acesso é de 1966 até o presente.

[http://wokinfo.com/products\\_tools/multidisciplinary/dii/](http://wokinfo.com/products_tools/multidisciplinary/dii/)



# Portal Periódicos CAPES

<http://www.periodicos.capes.gov.br>

## Scopus

Disponível desde 13.01.06

The logo for SCOPUS, featuring the word "SCOPUS" in a bold, blue, sans-serif font. The letter "O" is stylized with a white dot in the center, resembling a globe or a lens.

Base de dados referencial nas áreas de Ciências Biológicas, Ciências da Saúde, Ciências Físicas e Ciências Sociais.

Oferece acesso a base referencial, da Editora Elsevier, que indexa títulos acadêmicos revisados, títulos de acesso livre, anais de conferências, publicações comerciais, séries de livros, páginas web de conteúdo científico(reunidos no Scirus) e patentes de escritórios. Dispõe de funcionalidades de apoio à análise de resultados(bibliometria), como identificação de autores e filiações, análise de citações, análise de publicações e índice H. Cobre as áreas de Ciências Biológicas, Ciências da Saúde, Ciências Físicas e Ciências Sociais. Período de acesso desde 1823 até o presente.

<http://www.scopus.com/home.url>

# Portal Periódicos CAPES

<http://www.periodicos.capes.gov.br>

## CAB Abstracts

Disponível desde 01.12.00

Base de dados referencial nas áreas de Ciências Agrárias, Ciências Biológicas e Ciências Ambientais.

Oferece acesso a base de dados referencial CAB Abstract que é acessada através da plataforma Ovid. É uma base de dados compilada pela CAB INTERNATIONAL que contém resumos de aproximadamente 9.000 periódicos nas áreas de agricultura, agronomia, solos, pesticidas, horticultura, florestas, veterinária, fertilizantes, genética, meio ambiente, biologia e nutrição. Disponibilidade de acesso desde 1990 até o presente.

<http://www.ovid.com/site/catalog/DataBase/31.jsp>



---

## CABI compendia

Disponível desde 23.06.08

Enciclopédias interativas que reúnem informação científica nas áreas de agricultura, sistemas agroflorestais, pecuária, aquacultura.

Oferece acesso a 5 enciclopédias interativas da CABI compendia que reúnem uma grande variedade de informação científica nas áreas de ciências agrárias e ambientais. Cada Compêndio inclui informações de especialistas, editado e compilado por uma organização científica independente. São elas: Animal Health and Production Compendium; Aquaculture Compendium; Crop Protection Compendium; Forestry Compendium; e Invasive Species Compendium.

<http://www.cabi.org/default.aspx?site=170&page=1030>



# Portal Periódicos CAPES

<http://www.periodicos.capes.gov.br>

## Compendex Engineering Index (Ei)

Disponível desde 23.10.09

Base de dados referencial com registros nas áreas de Engenharia.

Oferece acesso a base referencial, Compendex Engineering Index, que publica mais de 10 milhões de registros e referências de mais de 5.600 periódicos e anais de conferências com disponibilidade desde 1969 até o presente. As publicações cobrem as áreas de Engenharia, Energia, Ciência da Computação, Robótica e Controle.

<http://www.engineeringvillage2.org/controller/servlet/Controller?CID=quickSearch&database=1>



# Portal Periódicos CAPES

<http://www.periodicos.capes.gov.br>

## INSPEC

Disponível desde 01.01.04

Acesse base de dados referencial da Institution of Engineering and Technology (IET).

A base INSPEC possui cobertura abrangente nos campos da eletrônica, ciência da computação, física, elétrica, controle, produção e engenharia mecânica. Disponibiliza resumos de artigos selecionados de cerca de 4.000 revistas científicas e técnicas, cerca de 2.500 conferências, bem como livros, relatórios e dissertações. Período disponível online desde 1969 até o presente.

<http://ovidsp.ovid.com/ovidweb.cgi?T=JS&NEWS=n&CSC=Y&PAGE=main&D=insz>





# Portal Periódicos CAPES

<http://www.periodicos.capes.gov.br>

## SciFinder

Disponível desde 03.01.05

Ferramenta de pesquisa do Chemical Abstracts Service (CAS), a SciFinder é um serviço de indexação de periódicos científicos na área de Química Orgânica, Química Inorgânica, Físicoquímica, Química Analítica, Engenharia Química, Processamento de Petróleo, Tintas, Revestimentos, Engenharia Sanitária, Poluição do Ar e da Água, Tratamento de Resíduos, Ciências Ambientais, Farmacologia, Toxicologia, Medicina Experimental, Biologia Celular e Molecular, Genética, Genoma, Proteoma, Bioquímica, Microbiologia, Enzimologia, Alimentos, Física, Química e Engenharia de Materiais, Polímeros, Elastômeros, Ligas, Cerâmica. Agrega informações de mais de 61 autoridades de patentes incluindo patentes anteriores a 1907. São seis bases de dados disponíveis:

- Caplus (1907-presente);
- Registry (1907-presente);
- Chemical Reactions (1840-presente);
- Substâncias Químicas Regulamentadas (1778-presente);
- CHEMCATS;
- Medline (Saúde).

<http://scifinder.cas.org>



# Portal Periódicos CAPES

<http://www.periodicos.capes.gov.br>

## Science Direct

Disponível desde 01.01.01

Acesso a textos completos em diversas áreas, além de arquivos multimídias, periódicos, livros eletrônicos e enciclopédias.

Oferece acesso a base Science Direct que permite acesso à coleção Freedom Collection. Esta coleção contém cerca de 1.800 periódicos em texto completo publicados pela Elsevier em todas as áreas do conhecimento, mas com foco nas áreas de ciências, tecnologia e medicina. A cobertura de texto completo dos periódicos da coleção está disponível desde 1995 até o presente.

<http://www.info.sciverse.com/sciencedirect>



# Fontes de Informações Patentárias (Comerciais)



- Questel FAMPAT
- Derwent WPI
- Chemical Abstracts CAPLUS
- Etc...
- Intellogist ([www.intellogist.com](http://www.intellogist.com))

# Fontes de Informações Patentárias (Comerciais)



- Questel Orbit
- Innography
- PatBase
- Derwent Innovations Index
- Thomson Innovation
- Total Patent
- Etc...
  
- Intellogist ([www.intellogist.com](http://www.intellogist.com))

# Ex. Questel Orbit

Formulário de busca intuitivo com múltiplos campos e possibilidades de combinação.

Orbit.com Coverage detail Latest News Download Patents Module Manual (Regular Search) Logout

Patents Search Patents... Searches General search Number search Citation search My Session Search history Search results Cost estimator Past Sessions Previous History Previous Analysis My Searches My saved searches My alerts My Lists Quicklist (0)

General search

Keywords

Title, Abstract, Key Content, Claims effervescent E.g.:Telecom+ OR phone

Title, Abstract, Key Content tablet

Classifications

and IPC Browse E.g.:G10L-015

Names

Assignee (Original or Current) Corporate Tree E.g.:Siemens Nixdorf

Inventor: E.g.:Fleming Alexander, Moyer Andrew

Representative: E.g.:Baker Botts

Numbers, Dates & Country

Publ. number E.g.:EP0980063

Date: No Restriction

Publication country: E.g.:US, EP

More fields

Abstracts

Restriction

Search Show the cmd. line Create script Clear

Geração automática de linha de comando avançada editável

Possibilidade de buscas avançadas com uso de conectores de proximidade, múltiplos parênteses, indexadores de campos e truncagem à direita, à esquerda e no meio de termos de busca

( (effervescent)/BI/SA/CLMS AND (tablet) )

# Ex. Questel Orbit

Formulário de busca intuitivo com múltiplos campos e possibilidades de combinação.

## Keywords

Title

Title

Title, Abstract

Title, Abstract, Claims

Title, Abstract, Key Content

Title, Abstract, Key Content, Claims

Claims

Description

Independent Claims

Key Content

Concepts

Full Text

## Restriction

Limit to the following legal status:

No restriction

No restriction

Patent in force

Opposition

Licensing

Term right extended

Ownership

Entry into national phase

Not in force

## Names

Assignee (Original or Current)

Assignee (Original or Current)

Current Assignee

Original Assignee

## Classifications

IPC

IPC

ECLA

ICO

US (main)

US (main & x-ref)

FI

F-Terms

## Numbers, Dates & Country

Publ. number

Publ. number

Appl. number

Priority number

Application or Priority number

## More fields

Abstracts

Advantages over prior art drawbacks

Object of invention

Citations, all

Citations, non patent References

Designated States

FamPat Family Number

PCT Publication number

PCT Application Nbr

Patent Assignee Country

Patent Assignee US State

Inventor Country

Inventor US State

Representative Country

US and FR Filing Details

Other Publication Dates

First Date of Pub.Appl.

First Date of Issued Grant

Patent Date, last pub.

First Family's Priority Date

EPO Dutch Class

Number of Patents in the FamPat Family

Number of Priorities in the FamPat Family

USPTO Examiner or US Representative

Independant claim number (US)

Number of claims (US)

Number of drawings (US)

Number of figures (US)

US Case ID

Abstracts

# Ex. Questel Orbit

Orbit.com

Patents

Full Text merged in families (FamPat) Bibliography by country (PlusPat) Full Text by publication

| Search Step | Result(s) | Query               | Assistant      | Source | Action                                |
|-------------|-----------|---------------------|----------------|--------|---------------------------------------|
| 4           | 2         | 3 AND BR/PC         | Search history | FAMPAT | Show results Modify Save Alert Delete |
| 3           | 179       | 1 AND 2             | Search history | FAMPAT | Show results Modify Save Alert Delete |
| 2           | 108077    | (KEYBOARD)/BI/SA    | General search | FAMPAT | Show results Modify Save Alert Delete |
| 1           | 52969     | (COLLAPSIBLE)/BI/SA | General search | FAMPAT | Show results Modify Save Alert Delete |

Searches

- General search
- Number search
- Citation search

My Session

- Search history
- Search results
- Cost estimator

Past Sessions

- Previous History
- Previous Analysis

My Searches

- My saved searches
- My alerts

My Lists

- Quicklist (0)

Combine strategies, E.g.: (1 or 2) not 3, 1 and (phone+)

3 and br/pc

Search

Possibilidade de gravação de buscas para posterior execução

Histórico de busca automaticamente gerado e pesquisável

# Ex. Questel Orbit

Painéis de visualização em paralelo e múltiplas opções de visualização permitem aumento de produtividade na avaliação dos documentos

Orbit.com | Display | Add to | Export | Top | Citations | Translate | Compare | Save | Alert | Analyse

181 results for (COLLAPSIBLE AND KEYBOARD)/BI/SA | Select all results, Clear selection | 100 results are selected. | Sort by relevance

Search Patents... | Searches | General search | Number search | Citation search | My Session | Search history | Search results | Cost estimator | Past Sessions | Previous History | Previous Analysis | My Searches | My saved searches | My alerts | My Lists | Quicklist (0)

| #   | Title                                                                                                                      | Original or current assignee                 | Publ. number | Pr. Date   |
|-----|----------------------------------------------------------------------------------------------------------------------------|----------------------------------------------|--------------|------------|
| 1.  | MULTI-PIECE STAND FOR MOBILE COMPUTING DEVICE                                                                              | BELKIN                                       | WO2011047217 | 2009-10-14 |
| 2.  | Electromagnetic isolation chamber for accurately manipulating devices therein                                              | LEEGATE GARY CONRAD; LEEGATE ROLLAND STEPHEN | US2011031009 | 2009-08-04 |
| 3.  | Bedtime Computer Table                                                                                                     | TCHOLAKOV STAYKO                             | US2010300334 | 2009-05-29 |
| 4.  | HANDHELD ELECTRONIC DEVICE AND KEYBOARD HAVING MULTIPLE-FUNCTION KEYS                                                      | FYKE STEVEN HENRY                            | US2010271309 | 2004-02-24 |
| 5.  | DETECTING KEY ACTUATION IN A KEYBOARD                                                                                      | OLODORT ROBERT; TANG JOHN; TURCHIK RANDY     | US2010271310 | 1997-11-12 |
| 6.  | (U3) Collapsible keyboard                                                                                                  |                                              | JP3092668    | 2002-09-09 |
| 7.  | Improvements in collapsible typewriting machines                                                                           | REMINGTON TYPEWRITER                         | US1467995    | 1922-01-31 |
| 8.  | Typewriting machine                                                                                                        | REMINGTON TYPEWRITER                         | US1468274    | 1922-03-16 |
| 9.  | HEIGHT-ADJUSTABLE EQUIPMENT STAND                                                                                          | JANSSEN RAINER                               | WO2009124523 | 2008-04-08 |
| 10. | COLLAPSIBLE KEYBOARD                                                                                                       | GIGA BYTE TECHNOLOGY; GYGA BYTE TECHNOLOGY   | WO2009100607 | 2008-01-31 |
| 11. | Split type laptop type collapsible soft keyboard                                                                           | XU CHEN                                      | CN101135932  | 2007-08-14 |
| 12. | Foldable electronic seat label                                                                                             | SHANGHAI BEIDA FOUNDERTECH COM               | CN200993853  | 2006-12-30 |
| 13. | Portable Computer Stand                                                                                                    | LEUNG CHILY C                                | US2008142662 | 2006-12-16 |
| 14. | Multimedia digital book                                                                                                    | LIU JIANSHENG                                | CN200976144  | 2006-11-24 |
| 15. | Bar, folding dual-purpose handset                                                                                          | XU GANGBIN                                   | CN200944615  | 2006-08-22 |
| 16. | ADAPTABLE BI-FOLD SCRAPBOOK AND CRAFT WORKSTATION                                                                          | ENSIGN INTERNATIONAL                         | WO2007146134 | 2006-06-07 |
| 17. | FOLDING ELECTRONIC PIANO COMPRISING KEYBOARD-STIFFENING MEANS                                                              | PARENTI RAOUL; RAOUL PARENTI                 | WO2006114531 | 2006-04-28 |
| 18. | ELECTRONIC DEVICE FOR CONDUCTING PROGRAMMED FUNCTIONS (VARIANTS) AND METHOD FOR INPUTTING COMMANDS IN SUCH A DEVICE        | LG ELECTRONICS                               | RU2319997    | 2005-12-30 |
| 19. | Keyboard and its input method                                                                                              | LENOVO                                       | CN100447718  | 2005-12-23 |
| 20. | DASHBOARD PROVIDED WITH FOLDABLE TABLE                                                                                     | RENAULT                                      | WO2007060352 | 2005-11-28 |
| 21. | COLLAPSIBLE PROJECTION ASSEMBLY                                                                                            | CTS; MOTOROLA                                | WO2006118760 | 2005-04-29 |
| 22. | Ventilation support for laptop computers                                                                                   | SAAD DAVID J                                 | US2006243678 | 2005-04-27 |
| 23. | HANDHELD ELECTRONIC DEVICE PROVIDING FEEDBACK TO FACILITATE NAVIGATION AND THE ENTRY OF INFORMATION, AND ASSOCIATED METHOD | RESEARCH IN MOTION                           | US2010315344 | 2005-02-09 |

Figure 2: A technical drawing of a collapsible keyboard assembly. It shows a keyboard body (1) with a connecting side (10) and a second side (22). A hand rest (2) is attached to the second side (22) and can be folded down. A connecting component (3) links the keyboard body (1) and the hand rest (2). The drawing is labeled '图 2' and '1=2'.

AB (WO2009100607)  
 A collapsible keyboard includes a keyboard body (1), a hand rest (2) and at least one connecting component (3). The keyboard body (1) has a connecting side (10) towards the side of the user. The hand rest (2) has a bearing surface (20), a first side (22) and a second side (23), the bearing surface (20) supporting the wrist of the user, the first side (22) facing the connecting side (10) of the keyboard body (1), the second side (23) locating the reverse side of the first side (22). The connecting component (3) is set between the keyboard body (1) and the hand rest (2), and the two ends of the connecting component (3) are connected rotatably to the keyboard body (1) and the hand rest (2) respectively, for folding the hand rest (2) to the rear of the keyboard body (1). The second side (23) is engaged with the rear of the keyboard body (1), and the connecting side (10) of the keyboard body (1) and the first side (22) of the hand rest (2) are formed a support plane, for erecting the keyboard body (1) in a manner that the connecting side (10) faces downwards. The collapsible keyboard can be stably and vertically folded to reduce the table space occupation.

IN LIN CHENHSING  
 PA GIGA BYTE TECHNOLOGY; GYGA BYTE TECHNOLOGY  
 PAH (WO2009100607) (A1) GYGA BYTE TECHNOLOGY CO LTD (CN); LIN CHENHSING (CN)  
 (CN201145884U) (Y) GIGA BYTE TECH CO LTD (CN)  
 PA0 LIN, Chenhsing / No. 6, Bau Chiang Road, Hsin-Tien (CN) (only US)  
 RP (WO2009100607)

Page 1 of 2 | Record 10 of 181 | Displaying records 1 - 100 of 181



# Ex. Questel Orbit

Possibilidade de edição dos termos grifados e gravação de perfis para uso posterior.

The screenshot displays the Questel Orbit patent search interface. The main window shows a patent record for "FOLDING KEYBOARD FOR A PERSONAL DIGITAL ASSISTANT" (WO200208877). The abstract describes a folding keyboard for personal digital assistants that is compact and easy to use. A "Highlight Wizard" dialog box is open, allowing the user to create or edit search profiles. The dialog box contains a list of profiles with checkboxes and color-coded boxes. The "Last search" profile is selected, and it contains the terms "collaps+", "fold+", and "retract+". Other profiles include "keyboard", "+inflammatory", "cold,cool+,freez+", "polymeri+ation", and "brake disc". The background shows the patent details page, including the title, abstract, and a technical drawing of the keyboard.

**Patent Title:** FOLDING KEYBOARD FOR A PERSONAL DIGITAL ASSISTANT

**Publ. number:** JP2004513415

**Pub. date:** 20040430

**Abstract:** Prior collapsible keyboards for personal digital assistants are overly complex and large. The present invention provides a folding keyboard for a personal digital assistant which folds up simply and in a small size and which is useful for standard typists. It is divided into two halves hingedly connected along a fold line. While the central or home row keys are standard size, the other two rows of keys are of reduced transverse dimension and are preferably so shaped as to allow a touch typist to use existing movements without missing the keys of reduced size.

**Highlight Wizard:**

Fill in the form to highlight specific terms.

My profiles: Last search

- collaps+, fold+, retract+ E.g.: bicycl+
- keyboard E.g.: +digest+
- E.g.: +inflammatory
- E.g.: cold,cool+,freez+
- E.g.: polymeri+ation
- E.g.: brake disc

Buttons: Clear, Apply, Ok, Cancel

**Patent Classification:** G06F 1/16 (74) Agent: GREEN, Bruce, M.; Owen Wiggs Green & Mutsaers, 601 West Cordova Street #480, Vancouver, British Columbia V6B 1G1 (CA).

**International Publication Number:** WO 02/08877 A2

**Abstract:** (57) Abstract: Prior collapsible keyboards for personal digital assistants are overly complex and large. The present invention provides a folding keyboard for a personal digital assistant which folds up simply and in a small size and which is useful for standard typists. It is divided into two halves hingedly connected along a fold line. While the central or home row keys are standard size, the other two rows of keys are of reduced transverse dimension and are preferably so shaped as to allow a touch typist to use existing movements without missing the keys of reduced size.

**Technical Drawing:** A diagram of a keyboard layout with numbered parts (10, 12, 13, 14, 15, 16, 17, 18, 19, 20, 21, 22, 23, 24, 25, 26, 27, 28, 29, 30, 31, 32, 33, 34, 35, 36, 37, 38, 39, 40, 41, 42, 43, 44, 45, 46, 47, 48, 49, 50, 51, 52, 53, 54, 55, 56, 57, 58, 59, 60, 61, 62, 63, 64, 65, 66, 67, 68, 69, 70, 71, 72, 73, 74, 75, 76, 77, 78, 79, 80, 81, 82, 83, 84, 85, 86, 87, 88, 89, 90, 91, 92, 93, 94, 95, 96, 97, 98, 99, 100).

# Ex. Questel Orbit

Barra de rolagem mostra a localização dos termos grifados no texto integral

The screenshot shows the Questel Orbit web interface. On the left is a sidebar with a list of patent family members. The main content area displays the details of a patent record for (A2) FOLDING KEYBOARD FOR A PERSONAL DIGITAL ASSISTANT. The record includes the title, abstract, and a table of publications. A vertical scrollbar on the right side of the main content area is highlighted with a purple callout box, indicating that it shows the location of highlighted terms in the full text. Below the main content area, there is a section for 'Published As' with a table of publications. A second purple callout box points to this section, stating that the 'Fulltext' mode allows for reading the description and visualization of figures in parallel. At the bottom right, a technical drawing of a folding keyboard is shown with various parts labeled with numbers.

**(A2) FOLDING KEYBOARD FOR A PERSONAL DIGITAL ASSISTANT**

FT  
(A2) CLAVIER REPLIABLE POUR UN ORDINATEUR DE POCHE

AB  
Prior **collapsible keyboards** for personal digital assistants are overly complex and large. The present invention provides a **folding keyboard** for a personal digital assistant which **folds** up simply and in a small size and which is useful for standard typists. It is divided into two halves hingedly connected along a **fold** line. While the central or home row keys are standard size, the other two rows of keys are of reduced transverse dimension and are preferably so shaped as to allow a touch typist to use existing movements without missing the keys of reduced size.

FAB  
Les claviers pliants connus, équipant les ordinateurs de poche, sont extrêmement complexes et encombrants. Le clavier pliant selon l'invention, destiné à un ordinateur de poche, se plie simplement, est peu encombrant et peut être utilisé pour des travaux de dactylographie standard. Il est divisé en deux parties égales, reliées de manière articulée le long d'une ligne de repliement. Les touches de la rangée centrale et de la rangée d'appui sont de dimensions standard, tandis que les deux autres rangées de touches présentent des dimensions réduites transversalement et sont configurées de préférence de façon à permettre à un dactylographe qualifié d'avoir recours aux mouvements existants sans rater les touches de dimensions réduites.

III (A2) KATZ MICHAEL (CA)  
PA KATZ MICHAEL (CA)  
PAH (A2) KATZ MICHAEL (CA)  
PA0 KATZ, Michael; 105 West 18th Avenue, Vancouver, British Columbia V5Y 2A6 (CA)  
PA1 (A2) KATZ MICHAEL (CA)  
RP (A2) GREEN, Bruce, M.; Oyen Wiggs Green & Mutala, 601 West Cordova Street #480, Vancouver, British Columbia V6B 1G1 [CA]

**Published As**

| Publ. number                                                                                                                                                                                             | Publ. date | Appl. number | Appl. date | Publ. Stage | Links |
|----------------------------------------------------------------------------------------------------------------------------------------------------------------------------------------------------------|------------|--------------|------------|-------------|-------|
| PCT WO/200877                                                                                                                                                                                            | 20020131   |              |            | A2 -        |       |
| AP<br>WOCA0100983 20010718 [2001WO-CA00983]                                                                                                                                                              |            |              |            |             |       |
| PR<br>US85015801 20010508 [2001US-0850158]<br>US21912500P 20000719 [2000US-P219125P]                                                                                                                     |            |              |            |             |       |
| FD<br>US85015801 20010508 [2001US-0850158] : 8501580120010508 [2001US-0850158]                                                                                                                           |            |              |            |             |       |
| IC<br>G06F-001/16                                                                                                                                                                                        |            |              |            |             |       |
| ICO<br>T04M-001/02A2B4<br>T04M-001/725F1B                                                                                                                                                                |            |              |            |             |       |
| ICAA<br>G06F-003/02 [2006-01 A F I R M JP];<br>G06F-001/16 [2006-01 A - I R M EP];<br>H01H-013/702 [2006-01 A L I R M JP];<br>H04M-001/02 [2006-01 A - I R M EP];<br>H04M-001/23 [2006-01 A - I R M EP]; |            |              |            |             |       |

(12) INTERNATIONAL APPLICATION PUBLISHED UNDER THE PATENT COOPERATION TREATY (PCT)

(19) World Intellectual Property Organization  
International Bureau

(43) International Publication Date  
31 January 2002 (31.01.2002)

(10) International Publication Number  
WO 02/08877 A2

(51) International Patent Classification: G06F 1/16 (74) Agent: GREEN, Bruce, M.; Oyen Wiggs Green & Mutala, 601 West Cordova Street #480, Vancouver, British Columbia V6B 1G1 (CA).

(21) International Application Number: PCT/CA01/00983

(22) International Filing Date: 18 July 2001 (18.07.2001)

(25) Filing Language: English

(26) Publication Language: English

(30) Priority Data:  
60219,125 19 July 2000 (19.07.2000) US  
090880,158 8 May 2001 (08.05.2001) US

(63) Related by continuation (CON) or continuation-in-part (CIP) to earlier application:  
090880,158 (CON)  
Filed on 8 May 2001 (08.05.2001)

(84) Designated States (regional): ARIPO patent (GH, GM, KE, LS, MW, MZ, SD, SL, SZ, TZ, UG, ZW), Eurasian patent (AM, AZ, BY, KG, KZ, MD, RU, TJ, TM), European patent (AT, BE, CH, CY, DE, DK, ES, FI, FR, GB, GR, IE, IT, LI, MC, NL, PT, SE, TR), OAPI patent (BF, BJ, CF, CG, CI, CM, GA, GN, GQ, GW, ML, MR, NE, NI, SN, TD, TG).

(71) Applicant and  
(72) Inventor: KATZ, Michael [CA/CA]; 105 West 18th Avenue, Vancouver, British Columbia V5Y 2A6 (CA).

(54) Title: FOLDING KEYBOARD FOR A PERSONAL DIGITAL ASSISTANT

(57) Abstract: Prior collapsible keyboards for personal digital assistants are overly complex and large. The present invention provides a folding keyboard for a personal digital assistant which folds up simply and in a small size and which is useful for standard typists. It is divided into two halves hingedly connected along a fold line. While the central or home row keys are standard size, the other two rows of keys are of reduced transverse dimension and are preferably so shaped as to allow a touch typist to use existing movements without missing the keys of reduced size.

Visualização em modo "Fulltext" permite leitura de descrição e visualização de figuras em paralelo

# Ex. Questel Orbit

Possibilidade de ordenamento dos resultados por relevância

The screenshot displays the Questel Orbit patent search interface. The search criteria are '( collapsible)/BI/SA AND (keyboard)/BI/SA', resulting in 179 records. The results are sorted by relevance. The interface includes a search menu on the left, a main results table, and a detailed view on the right.

| #   | Title                                                                                              | Original or current assignee                    | Publ. number    | Pr. Date   |
|-----|----------------------------------------------------------------------------------------------------|-------------------------------------------------|-----------------|------------|
| 51. | Collapsible keyboard                                                                               | CHANGSHU SUNREX TECHNOLOGY                      | US6547463       | 2002-01-16 |
| 52. | WIRELESS KEYBOARD FOR HAND-HELD COMPUTERS                                                          | POCKETOP COMP, POCKETOP COMPUTER                | WO03060681      | 2002-01-04 |
| 53. | Collapsible keyboard                                                                               | DARFON ELECTRONICS                              | US2003122690    | 2001-12-28 |
| 54. | COLLAPSIBLE PORTABLE COMMUNICATION TERMINAL                                                        | FDK                                             | JP2003198664    | 2001-12-28 |
| 55. | MECHANISM FOR UNFOLDING AND FOLDING OF FOLDING KEYBOARDS OF PORTABLE COMPUTERS AND SIMILAR DEVICES | KORSAKOV GRIGORU                                | WO2004006077    | 2001-12-11 |
| 56. | Collapsible keyboard                                                                               | LITE ON TECHNOLOGY                              | US2003063939    | 2001-09-28 |
| 57. | Collapsible keyboard                                                                               | YAN HUEI SHIANG; YEN HUEY SHIANG                | US2003048595    | 2001-09-10 |
| 58. | Foldable keyboard work platform and carrying case                                                  |                                                 | US2003034263    | 2001-08-17 |
| 59. | Key switch                                                                                         | BEHAVIOR TECH COMPUTER                          | US2003029708    | 2001-08-10 |
| 60. | Collapsible keyboard                                                                               | BEHAVIOR TECH COMPUTER                          | US2003030623    | 2001-08-10 |
| 61. | Collapsible folding mini USB/MIDI keyboard controller                                              |                                                 | US2003019346    | 2001-07-27 |
| 62. | POP-UP ELECTRONIC EQUIPMENT ENCLOSURE                                                              | LAPDOME                                         | WO0200000000    | 2001-06-06 |
| 63. | COLLAPSIBLE PANEL FOR AN ELECTRONIC DEVICE                                                         | BORUCKI GREGORY C; CECCHI MARINO; QUINN BRIAN P | US2002004051618 | 2001-05-11 |
| 64. | Stroller with programmable information module                                                      | GERICO CHILDREN'S PRODUCTS CO                   | US20020132612   | 2001-05-09 |
| 65. | Flat hanging computer mouse                                                                        |                                                 | US2002002149905 | 2001-04-11 |
| 66. | Height-adjusting collapsible button key                                                            |                                                 | US2002002148711 | 2001-04-11 |
| 67. | Portable computer                                                                                  |                                                 | US2002002100398 | 2001-01-31 |
| 68. | Ergonomic furniture                                                                                | FARIA SABRINA ANN; LAWRENCE R C                 | GB2369565       | 2000-12-04 |
| 69. | Collapsible computer mouse pad                                                                     |                                                 | US2002117588    | 2000-10-04 |
| 70. | FOLDING KEYBOARD FOR A PERSONAL DIGITAL ASSISTANT                                                  | KATZ MICHAEL; MICHAEL KATZ; POCKETOP COMPUTERS  | WO200208877     | 2000-07-19 |
| 71. | Folding keyboard for a personal digital assistant                                                  | POCKETOP COMPUTERS                              | US2005025551    | 2000-07-19 |
| 72. | Method and system for web management                                                               | EGRAIL                                          | EP1172734       | 2000-07-12 |
| 73. | Collapsible keyboard                                                                               | DARFON ELECTRONICS                              | US2002003530    | 2000-07-05 |
| 74. | Collapsible keyboard                                                                               | ACER; DARFON ELECTRONICS                        | US2002001498    | 2000-07-01 |
| 75. | Electronic device with collapsible display                                                         | IPG ELECTRONICS S03; PHILIPS                    | EP1193953       | 2000-06-30 |

The detailed view on the right shows the 'Legal Status' for the patent family AU7562701 A. It includes information such as 'Dead: US2002030965 A1, US6594142 B2' and 'Dead: CA2366636 A1'. The status is listed as 'Legal Status N/A'.

Visualização do "Legal Status" para cada família de patentes: Modo Textual

# Ex. Questel Orbit

Orbit.com | Display | Add to | Export | Top | Citations | Translate | Compare | Save | Alert

179 results for ((collapsible)/BI/SA AND (keyboard)/BI/SA)

Google | Sort by relevance

| #   | Title                                                                                              | Original or current assignee                       | Publ. number | Pr. Date   |
|-----|----------------------------------------------------------------------------------------------------|----------------------------------------------------|--------------|------------|
| 51. | Collapsible keyboard                                                                               | CHANGSHU SUNREX TECHNOLOGY                         | US6547463    | 2002-01-16 |
| 52. | WIRELESS KEYBOARD FOR HAND-HELD COMPUTERS                                                          | POCKETOP COMP, POCKETOP COMPUTER                   | WO03060681   | 2002-01-04 |
| 53. | Collapsible keyboard                                                                               | DARFON ELECTRONICS                                 | US2003122690 | 2001-12-28 |
| 54. | COLLAPSIBLE PORTABLE COMMUNICATION TERMINAL                                                        | FDK                                                | JP2003198664 | 2001-12-28 |
| 55. | MECHANISM FOR UNFOLDING AND FOLDING OF FOLDING KEYBOARDS OF PORTABLE COMPUTERS AND SIMILAR DEVICES | KORSAKOV GRIGORU                                   | WO2004006077 | 2001-12-11 |
| 56. | Collapsible keyboard                                                                               | LITE ON TECHNOLOGY                                 | US2003063939 | 2001-09-28 |
| 57. | Collapsible keyboard                                                                               | YAN HUEI SHIANG; YEN HUEY SHIANG                   | US2003048595 | 2001-09-10 |
| 58. | Foldable keyboard work platform and carrying case                                                  |                                                    | US2003034263 | 2001-08-17 |
| 59. | Key switch                                                                                         | BEHAVIOR TECH COMPUTER                             | US2003029708 | 2001-08-10 |
| 60. | Collapsible keyboard                                                                               | BEHAVIOR TECH COMPUTER                             | US2003030623 | 2001-08-10 |
| 61. | Collapsible/folding mini USB/MIDI keyboard controller                                              |                                                    | US2003019346 | 2001-07-27 |
| 62. | POP-UP ELECTRONIC EQUIPMENT ENCLOSURE                                                              | LAPDOME                                            | WO02098763   | 2001-06-06 |
| 63. | COLLAPSIBLE PANEL FOR AN ELECTRONIC DEVICE                                                         | BORUCKI GREGORY C; CECCHI MARINO; QUINN BRIAN P    | WO2004051618 | 2001-05-11 |
| 64. | Stroller with programmable information module                                                      | GERICO CHILDREN PRODUCTS; GRACO CHILDRENS PRODUCTS | US2003132612 | 2001-05-09 |
| 65. | Flat hanging computer                                                                              | HEWLETT PACKARD; HEWLETT PACKARD DEVELOPMENT       | US2002149905 | 2001-04-11 |
| 66. | Height-adjusting collapsible mechanism for a button key                                            | DARFON ELECTRONICS                                 | US2002148711 | 2001-04-11 |
| 67. | Portable computer stand for a laptop computer                                                      |                                                    | US2002100398 | 2001-01-31 |
| 68. | Ergonomic furniture                                                                                | FARIA SABRINA ANN; LAWRENCE R C                    | GB2369565    | 2000-12-04 |
| 69. | Collapsible computer mouse pad                                                                     |                                                    | US2002117588 | 2000-10-04 |
| 70. | FOLDING KEYBOARD FOR A PERSONAL DIGITAL ASSISTANT                                                  | KATZ MICHAEL; MICHAEL KATZ; POCKETOP COMPUTERS     | WO200208877  | 2000-07-19 |
| 71. | Folding keyboard for a personal digital assistant                                                  | POCKETOP COMPUTERS                                 | US2005025551 | 2000-07-19 |
| 72. | Method and system for web management                                                               | EGRAL                                              | EP1172734    | 2000-07-12 |
| 73. | Collapsible keyboard                                                                               | DARFON ELECTRONICS                                 | US2002003530 | 2000-07-05 |
| 74. | Collapsible keyboard                                                                               | ACER; DARFON ELECTRONICS                           | US2002001498 | 2000-07-01 |
| 75. | Electronic device with collapsible display                                                         | IPG ELECTRONICS S03; PHILIPS                       | EP1193953    | 2000-06-30 |

Claims | Key Content | Fulltext | Legal Status | Timeline (beta)

Appl. Folding cellular telephone and digital assistant with

|              | 01 | 02 | 03 | 04 | 05 | 06 | 07 | 08 | 09 | 10 | 11 |
|--------------|----|----|----|----|----|----|----|----|----|----|----|
| Published As |    |    |    |    |    |    |    |    |    |    |    |
| WO200208877  | ■  | ■  | ■  | ■  | ■  | ■  | ■  | ■  | ■  | ■  | ■  |
| AU7225201    | ■  | ■  | ■  | ■  | ■  | ■  | ■  | ■  | ■  | ■  | ■  |
| EP1305699    | ■  | ■  | ■  | ■  | ■  | ■  | ■  | ■  | ■  | ■  | ■  |
| JP2004513415 | ■  | ■  | ■  | ■  | ■  | ■  | ■  | ■  | ■  | ■  | ■  |
| WO200208876  | ■  | ■  | ■  | ■  | ■  | ■  | ■  | ■  | ■  | ■  | ■  |
| AU7562701    | ■  | ■  | ■  | ■  | ■  | ■  | ■  | ■  | ■  | ■  | ■  |
| US2002030965 | ■  | ■  | ■  | ■  | ■  | ■  | ■  | ■  | ■  | ■  | ■  |
| CA2366636    | ■  | ■  | ■  | ■  | ■  | ■  | ■  | ■  | ■  | ■  | ■  |
| US2002191999 | ■  | ■  | ■  | ■  | ■  | ■  | ■  | ■  | ■  | ■  | ■  |

■ Applied   ■ Published, Restored   ■ Granted, Extended   ■ Rejected, Invalid  
 ■ Expired, Revoked, Lapsed   ■ Abandoned, Withdraw, Cancelled

Visualização do "Legal Status" para cada família de patentes: Modo Gráfico - "Timeline"

Page 3 of 8 | Record 70 of 179 | Displaying records 51 - 75 of 179

# Ex. Questel Orbit

Buscas por citações por múltiplas famílias simultaneamente e em diversas categorias

The screenshot displays the Questel Orbit patent search interface. The search results are filtered for 'KEYBOARD' and 'COLLAPSIBLE'. The interface includes a search bar, navigation tabs, and a list of search results. A callout box highlights the search criteria.

**Search Results:**

| #  | Title                                                                         | Publ. number | Pr. Date   |
|----|-------------------------------------------------------------------------------|--------------|------------|
| 1. | Electromagnetic isolation chamber for accurately manipulating devices therein | US2011031009 | 2009-08-04 |
| 2. | Bedtime Computer Table                                                        | US2010300334 | 2009-05-29 |
| 3. | HANDHELD ELECTRONIC DEVICE AND KEYBOARD HAVING MULTIPLE-FUNCTION KEYS         | US2010271309 | 2004-02-24 |
| 4. | DETECTING KEY ACTUATION IN A KEYBOARD                                         | US2010271310 | 1997-11-12 |

**Search Criteria (Callout Box):**

- In any categories
- In category X
- In category Y
- In category X or Y

**Document Details (Right Panel):**

**Published As:**

| Publ. number       | Pub. date | Appl. number   | Appl. date | Publ. Stage | Links |
|--------------------|-----------|----------------|------------|-------------|-------|
| PCT WO/2009/100607 | 20090820  | 2008WO-CN02107 | 20081229   | A1 - In     |       |
| CN201145884        | 20081105  | 2008CN-U003367 | 20080131   | Y - Gri     |       |

**Cited Patents:**

| Publ. number | Pub. date | Original or current assignee | Cat. | # | Links |
|--------------|-----------|------------------------------|------|---|-------|
| DE20317278   | 20040115  | CHERRY                       | Y    | 1 |       |

**Document type:** U1 - Utility model  
**Appl. number:** 2003DE-2017278  
**Appl. date:** 20031110

**Title: Keyboard for computers has a hand support section that is hinged on to the main body and can be moved through an arc to act as a stand**

**Document type:** A1 - First published patent application  
**Appl. number:** 2001US-0814613  
**Appl. date:** 20010322

**No citing patent**

Page 1 of 2 | Record 8 of 179 | Displaying records 1 - 100 of 179



# Ex. Questel Orbit

Visualização apenas de figuras representativas para cada família de patentes

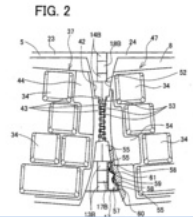
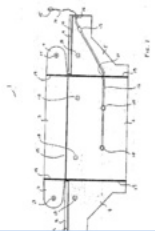
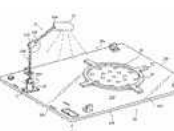
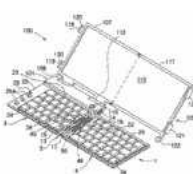
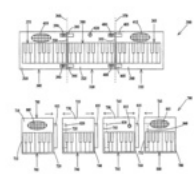
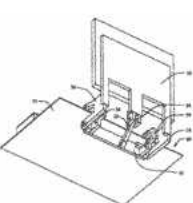
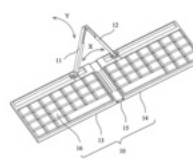
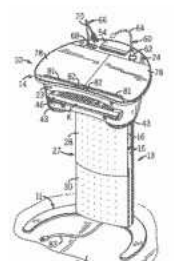


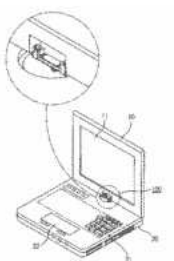
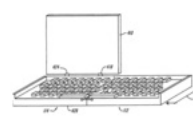
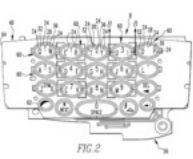
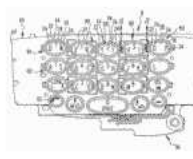
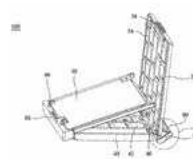
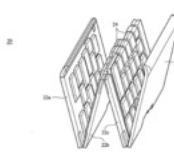
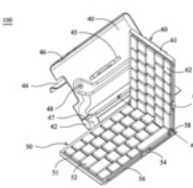
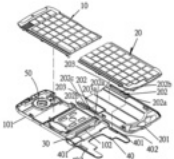
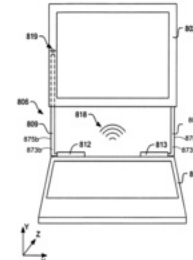
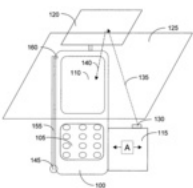
Orbit.com | Display | Add to | Export | Top | Citations | Compare | Save | Alert | Analyse

179 results for ((COLLAPSIBLE)/BI/SA AND (KEYBOARD)/BI/SA)

FAMPAT | Clear selection | 179 results are selected.

Google | Sort by relevance

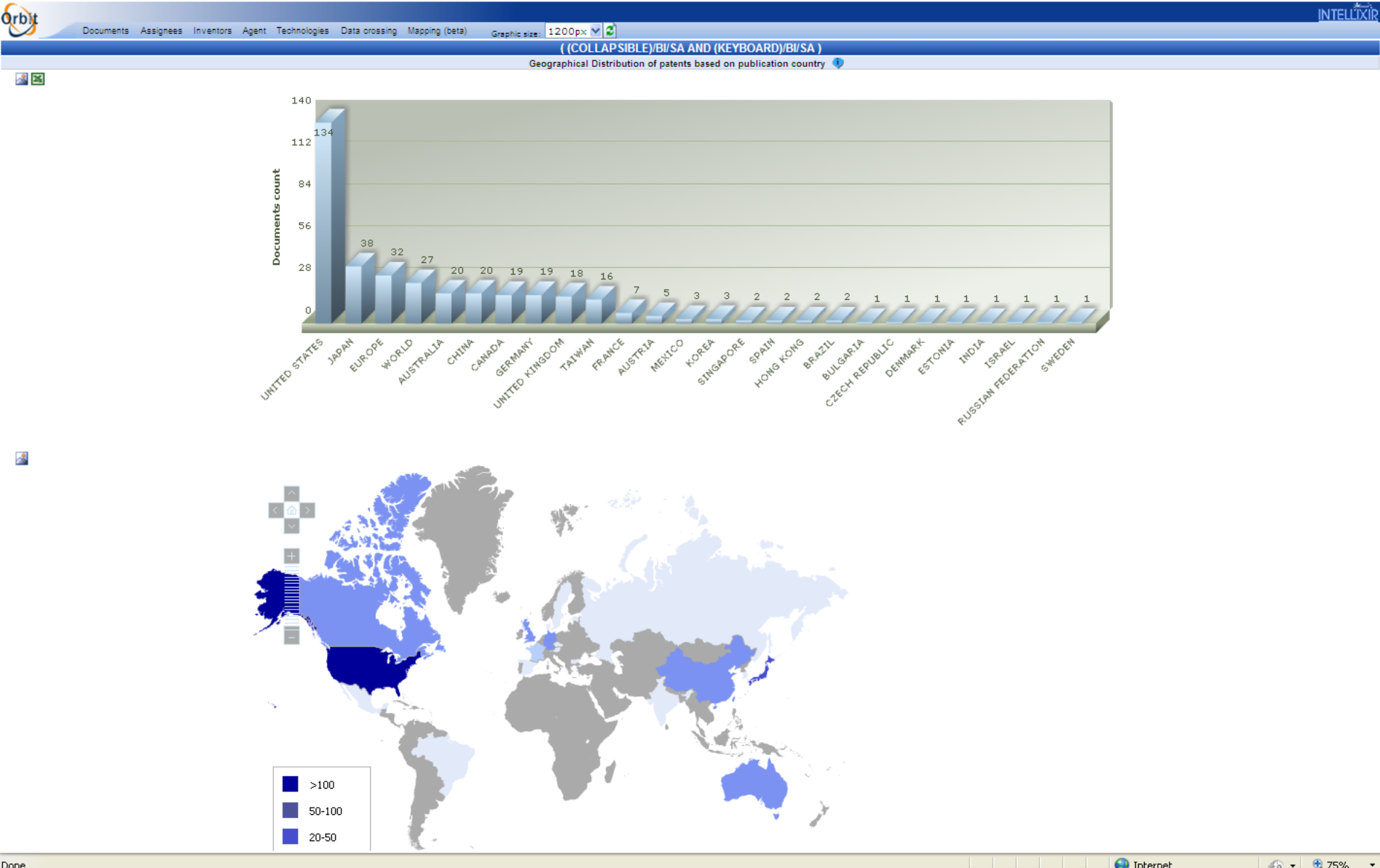
| #                                   | Title                                | Original or current assignee | Publ. number | Pr. Date |
|-------------------------------------|--------------------------------------|------------------------------|--------------|----------|
| <input checked="" type="checkbox"/> | <b>COLLAPSIBLE</b> PROJECTION ...    |                              |              |          |
| <input checked="" type="checkbox"/> | Ventilation support for lapt...      |                              |              |          |
| <input checked="" type="checkbox"/> | <b>HANDHELD ELECTRONIC DEV...</b>    |                              |              |          |
| <input checked="" type="checkbox"/> | Handheld electronic device...        |                              |              |          |
| <input checked="" type="checkbox"/> | Handheld electronic device...        |                              |              |          |
| <input checked="" type="checkbox"/> | Handheld electronic device...        |                              |              |          |
| <input checked="" type="checkbox"/> | <b>MUSICAL INSTRUMENT SUP...</b>     |                              |              |          |
| <input checked="" type="checkbox"/> | <b>COLLAPSIBLE</b> PORTABLE DI...    |                              |              |          |
| <input checked="" type="checkbox"/> | <b>ADJUSTABLE PORTABLE CO...</b>     |                              |              |          |
| <input checked="" type="checkbox"/> | Innovated <b>keyboard</b> for per... |                              |              |          |
| <input checked="" type="checkbox"/> | <b>Collapsible keyboard</b>          |                              |              |          |
| <input checked="" type="checkbox"/> | <b>COLLAPSIBLE KEYBOARD</b>          |                              |              |          |
| <input checked="" type="checkbox"/> | <b>Collapsible keyboard</b>          |                              |              |          |
| <input checked="" type="checkbox"/> | Handheld Electronic Device ...       |                              |              |          |
| <input checked="" type="checkbox"/> | Handheld electronic device...        |                              |              |          |
| <input checked="" type="checkbox"/> | Multifunctional portable co...       |                              |              |          |
| <input checked="" type="checkbox"/> | Modularized electronic dev...        |                              |              |          |
| <input checked="" type="checkbox"/> | An auxiliary device of learni...     |                              |              |          |
| <input checked="" type="checkbox"/> | Tabulate computer                    |                              |              |          |
| <input checked="" type="checkbox"/> | Lectern                              |                              |              |          |
| <input checked="" type="checkbox"/> | <b>Collapsible keyboard</b> with ... |                              |              |          |



Page 1 of 2 | Record 8 of 179 | Displaying records 1 - 100 of 179

# Ex. Questel Orbit

Cobertura Geográfica  
(Publicações por Países)



# Ex. Questel Orbit

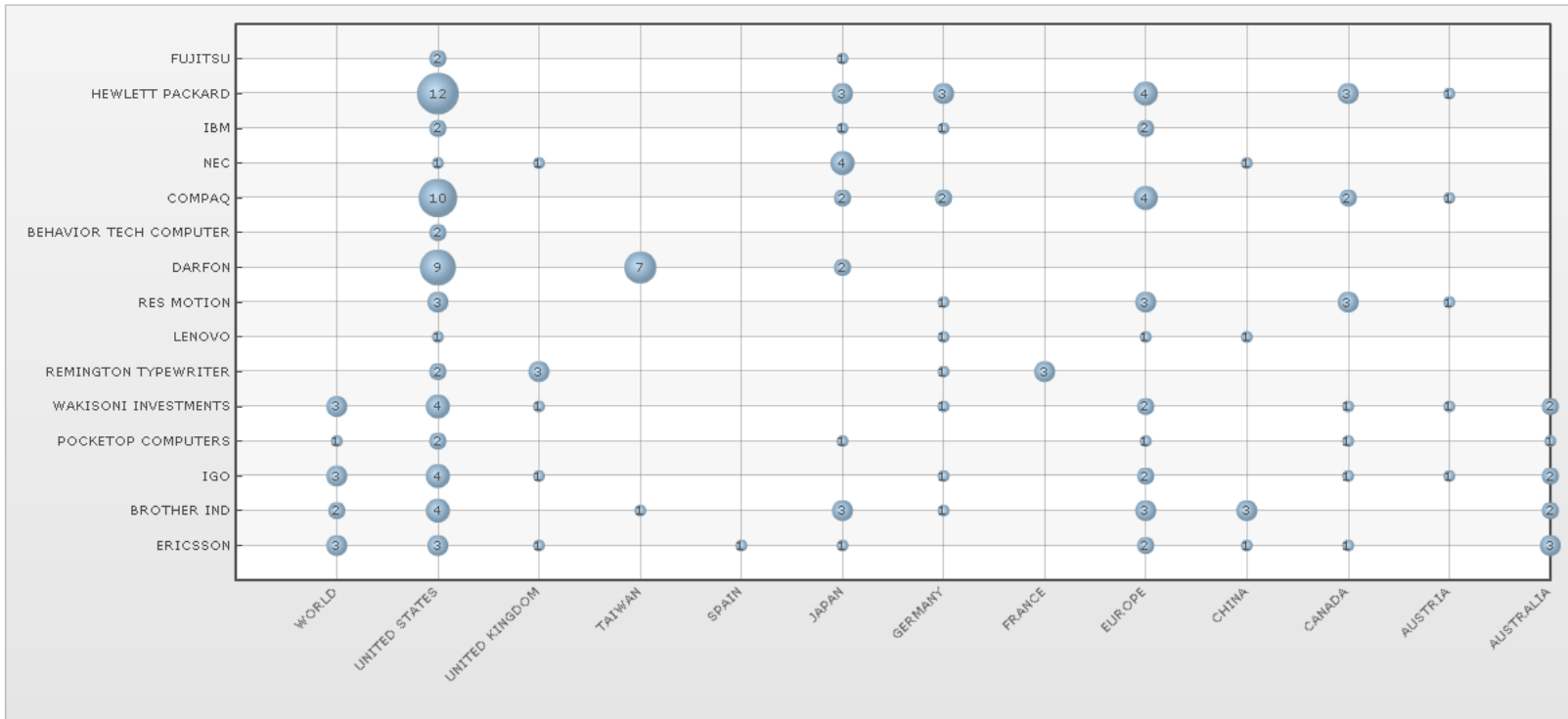
## Cobertura Geográfica Principais Depositantes



Documents Assignees Inventors Agent Technologies Data crossing Mapping (beta) Graphic size: 1200px

( (COLLAPSIBLE)/BI/SA AND (KEYBOARD)/BI/SA )

Bubble graph for Assignees/Patent country





# Ex. Questel Orbit

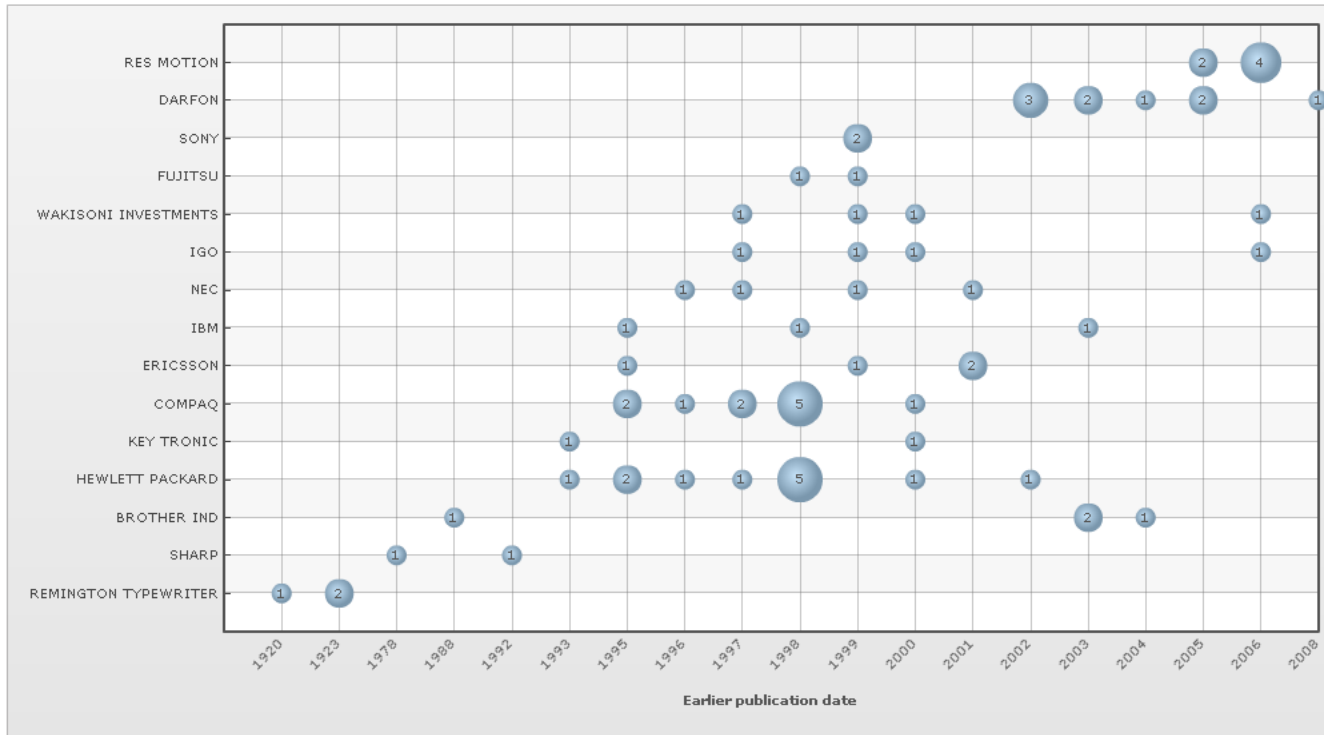
## Evolução Temporal Principais Depositantes



Documents Assignees Inventors Agent Technologies Data crossing Mapping (beta) Graphic size: 1000px

( (COLLAPSIBLE)/BI/SA AND (KEYBOARD)/BI/SA )

Evolution of top 15 assignees



# Ex. Questel Orbit

## Mapa de Citações: Titulares



Documents Assignees Inventors Agent Technologies Data crossing Mapping (beta) Graphic size: 1000px

( (COLLAPSIBLE)/BI/SA AND (KEYBOARD)/BI/SA )

Citations map

Category: All OK

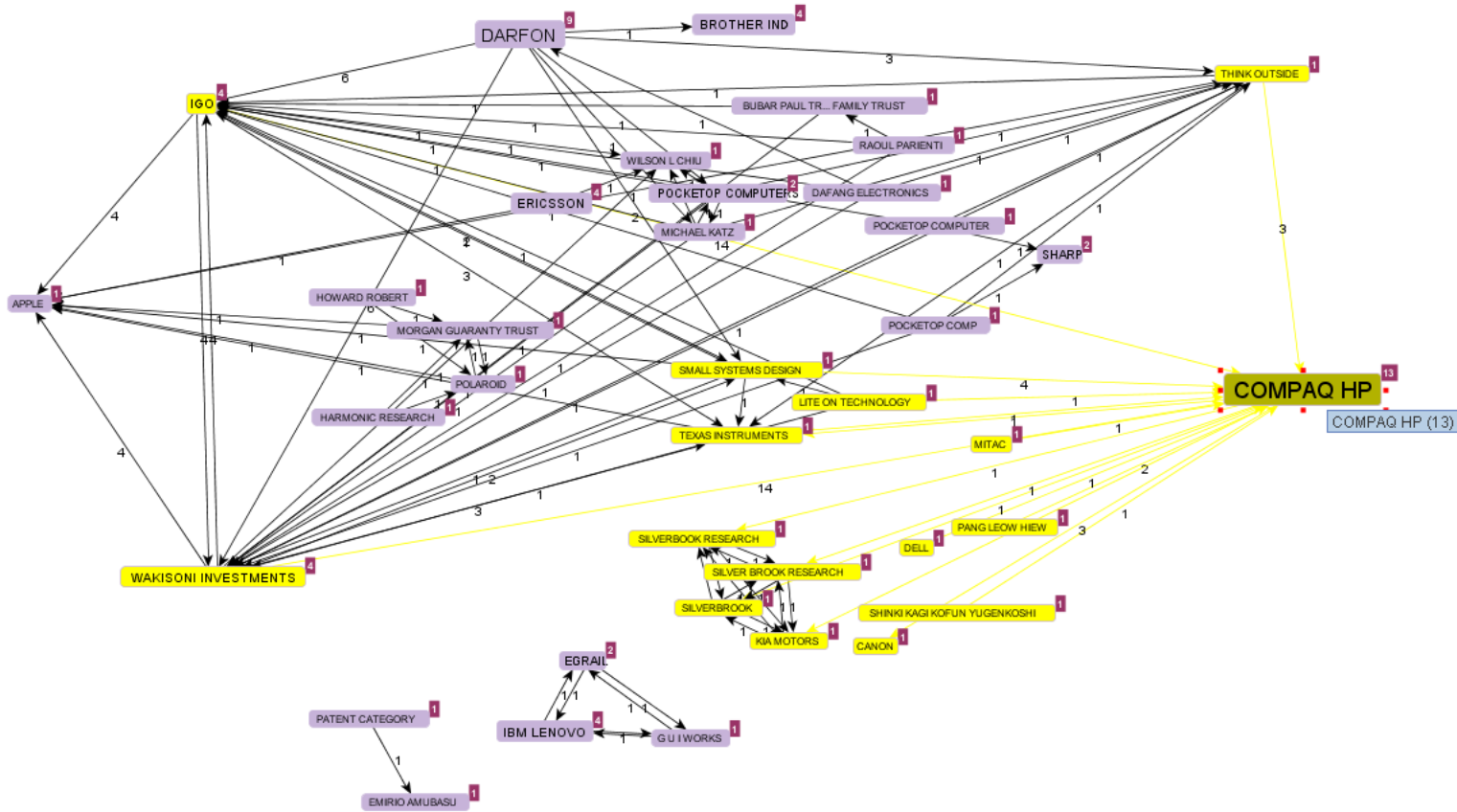
Zoom

Cocurrences 1 Min Occurrences 1 Min

Duration 11 years End date 2006 Update Reset

Min citing 0 Min cited 0

- HARMONIC RESEA
- MITAC
- CANON
- SHINKI KAGI KOFU
- PANG LEOW HIEW
- HOWARD ROBERT
- RAOUL PARIENTI
- POLAROID
- SHARP
- POCKETOP COMP
- EMIRIO AMUBASU
- PATENT CATEGOR
- G U I WORKS
- IBM LENOVO
- EGRAIL
- DAFANG ELECTRO
- BUBAR PAUL TR...
- BROTHER IND
- DARFON
- DELL
- KIA MOTORS
- TEXAS INSTRUME
- SMALL SYSTEMS
- SILVERBOOK RES
- POCKETOP COMP
- WAKISONI INVEST
- POCKETOP COMP
- MORGAN GUARAN
- THINK OUTSIDE
- MICHAEL KATZ
- COMPAQ HP
- LITE ON TECHNOL
- APPLE
- IGO



# Ex. Questel Orbit

Exportação para TXT, PDF, RTF, XLS, CSV, XML e Email. Exportação para VantagePoint, Intelixir, Bizint

The screenshot displays the Questel Orbit web interface. On the left, there is a navigation menu with sections like 'Searches', 'My Session', 'Past Sessions', 'My Searches', and 'My Lists'. The main area shows search results for 'Collapsible keyboard' with 179 results. A table lists patent entries with columns for title, assignee, publication number, and date. An export menu is open, showing options like 'Export as TXT', 'Export as PDF', 'Export as RTF', 'Export as XLS', 'Export as CSV', 'Export as XML', 'Email (permalinks)', 'Bizint Export', 'VantagePoint Export', 'Export Intelixir', and 'My export profiles'. On the right, a technical drawing of a keyboard mechanism is shown with numbered callouts (30, 40, 42, 50, 54, 56, 60, 66, 70, 80, 90). Below the drawing, there is a list of references (AB, PA, PAH, PA0, RP) and their corresponding patent information.

| #   | Title                                                                                                                                                                                         | Assignee                           | Publ. number | Pr. Date   |
|-----|-----------------------------------------------------------------------------------------------------------------------------------------------------------------------------------------------|------------------------------------|--------------|------------|
| 1.  | Computer alternate di method the                                                                                                                                                              | MITAC TECHNOLOGY; SHINKI KAGI K... | US2004093449 | 2002-11-12 |
| 2.  | Foldable ke                                                                                                                                                                                   | BROTHER INDUSTRIES                 | WO03104962   | 2002-06-04 |
| 3.  | Collapsible                                                                                                                                                                                   | DARFON ELECTRONICS                 | US2003122690 | 2001-12-28 |
| 4.  | Collapsible a computer                                                                                                                                                                        |                                    | US6256017    | 1994-02-24 |
| 5.  | Collapsible                                                                                                                                                                                   | DAFANG ELECTRONICS; DARFON EL...   | US2005224320 | 2004-04-09 |
| 6.  | Collapsible                                                                                                                                                                                   | DARFON ELECTRONICS                 | US2005258021 | 2004-05-21 |
| 7.  | Collapsible                                                                                                                                                                                   | DARFON ELECTRONICS                 | US2003197628 | 2002-04-17 |
| 8.  | Collapsible                                                                                                                                                                                   | IGO; WAKISONI INVESTMENTS          | WO9843156    | 1997-03-21 |
| 9.  | Collapsible                                                                                                                                                                                   | DARFON ELECTRONICS                 | US2002003530 | 2000-07-05 |
| 10. | Collapsible keyboard structure for a notebook computer                                                                                                                                        | COMPAQ COMPUTER; COMPAQ INFO...    | EP0691601    | 1994-06-30 |
| 11. | Foldable keyboard                                                                                                                                                                             | BROTHER INDUSTRIES                 | WO03104961   | 2002-06-04 |
| 12. | Collapsible keyboard                                                                                                                                                                          | BEHAVIOR TECHNOLOGY COMPUTER       | US2003030623 | 2001-08-10 |
| 13. | Collapsible keyboard with supporting structure                                                                                                                                                | DARFON ELECTRONICS                 | US2004175220 | 2003-03-07 |
| 14. | Collapsible keyboard                                                                                                                                                                          | LITE ON TECHNOLOGY                 | US2003063939 | 2001-09-28 |
| 15. | Collapsible keyboard                                                                                                                                                                          | DARFON ELECTRONICS                 | US2008173529 | 2004-04-09 |
| 16. | Collapsible keyboard pointing stick structure                                                                                                                                                 | COMPAQ INFORMATION TECHNOLOG...    | US5786806    | 1996-03-29 |
| 17. | Compact notebook computer having a foldable and collapsible keyboard structure                                                                                                                | COMPAQ COMPUTER; COMPAQ INFO...    | EP0691603    | 1994-06-30 |
| 18. | Collapsible keyboard                                                                                                                                                                          | APPLE                              | US5163765    | 1992-03-04 |
| 19. | Collapsible keyboard mechanism with integrated lcd display                                                                                                                                    | COMPAQ INFORMATION TECHNOLOG...    | US6137676    | 1998-05-22 |
| 20. | Collapsible keyboard                                                                                                                                                                          | IGO; SMALL SYSTEMS DESIGN; WAKI... | WO9824963    | 1997-11-12 |
| 21. | Double spring collapsible keyboard structure for a notebook computer, responsive to opening and closing of the computer's lid via relatively shiftable key support structure and shift member | COMPAQ INFORMATION TECHNOLOG...    | US5677826    | 1994-06-30 |
| 22. | Collapsible musical keyboard                                                                                                                                                                  | BUBAR PAUL TRUSTEE OF THE DAVI...  | US2004083877 | 2002-10-30 |
| 23. | Collapsible keyboard stand                                                                                                                                                                    | ULTIMATE SUPPORT SYSTEMS           | US4770380    | 1987-06-22 |

**Collapsible keyboard**

100

AB  
(US20050224320)  
A collapsible keyboard comprises a first key assembly, a second key assembly rotatably connected to the first key assembly and a third key assembly rotatably connected to the second key assembly. The first key assembly is located between the second and third key assemblies when the collapsible keyboard is in a collapsed mode, and the first key assembly, the second and third key assemblies are substantially located on the same level when the collapsible keyboard is in an operating mode.

III HSU CHIEN-SHIH  
PA DAFANG ELECTRONICS  
DARFON ELECTRONICS  
PAH (US20050224320)  
HSU CHIEN SHIH; FROM 20050317 TO 20050317  
DARFON ELECTRONICS; FROM 20050317  
(JP2005302016)  
(A) DAFANG ELECTRONICS CO LTD  
(TW-228739)  
(B) DARFON ELECTRONICS CORP (TW)  
(A) DARFON ELECTRONICS CORP  
PA0 Darfon Electronics Corporation, Taoyuan [TW]  
RP (US20050224320)  
(A1) QUINTERO LAW OFFICE; 1617 BROADWAY, 3RD FLOOR, SANTA MONICA, CA, 90404[US]  
(B2) Quintero Law Office

Page 1 of 8 Record 5 of 179

# Ex. Questel Orbit

Exportação de múltiplos campos, incluindo imagens, reivindicações, famílias de patentes, etc.

The screenshot displays the Questel Orbit interface with search results for 'FAMPAT' and two export dialog boxes. The search results list several patent entries, including 'Electromagnetic isolation chamber for manipulating devices therein', 'Bedtime Computer Table', 'HANDHELD ELECTRONIC DEVICE AND KEYBOARD HAVING MULTIPLE-FUNCTION KEYS', and 'DETECTING KEY ACTUATION IN A KEYBOARD'. The 'Template options' dialog box allows users to choose between 'Classical' and 'Kwic' templates, with a 'Patent number format' dropdown set to 'Short'. The 'Fields selection' dialog box lists various fields for export, such as 'FamPat Family Accession Number', 'Title - Other Languages', 'Priority Numbers and Dates', 'Inventor(s)', 'Assignee(s)', 'International Classification', 'European Classification', 'US Classification', 'Japanese Classification', 'English Abstract - Native or Official Trans.', 'English Abstract - Machine Translation', 'Abstract - Other Languages', 'Designated States', 'Key Info', 'Description', 'Claims', 'Patent and Non-Patent Literature Citations', 'Cited Patent Number Only', 'Legal Status', and 'Other:'. The interface also shows a sidebar with navigation options like 'Searches', 'My Session', 'Past Sessions', and 'My Searches'.

# Ex. Questel Orbit

Exportação de múltiplos campos, incluindo imagens, reivindicações, famílias de patentes, etc.

Microsoft Excel - Exemplo Relatório XLS

Arquivo Editar Exibir Inserir Formatar Ferramentas Dados Janela Ajuda Adobe PDF


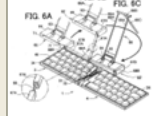
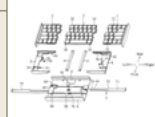
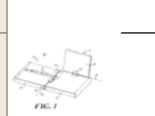
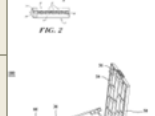
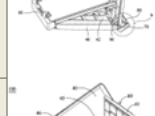
75%

Arial Unicode MS 10

Responder com alterações... Finalizar revisão...

Go to Office Live | Open | Save

D2 Computer system with collapsible keyboard and alternate display functions and processing method thereof

| IMAGE                                                                              | FAN            | XPN                                                                                                                                       | TI                                                                                                             | PA                                               | IC                                                                                                                    | AB                                                                                                                                                                                                                                                                                                                                                                                                                                                                                                                                                                     | ECLM                                                                                                                                                                                                                                                                                                                                                                                                                                                                                                                                   |
|------------------------------------------------------------------------------------|----------------|-------------------------------------------------------------------------------------------------------------------------------------------|----------------------------------------------------------------------------------------------------------------|--------------------------------------------------|-----------------------------------------------------------------------------------------------------------------------|------------------------------------------------------------------------------------------------------------------------------------------------------------------------------------------------------------------------------------------------------------------------------------------------------------------------------------------------------------------------------------------------------------------------------------------------------------------------------------------------------------------------------------------------------------------------|----------------------------------------------------------------------------------------------------------------------------------------------------------------------------------------------------------------------------------------------------------------------------------------------------------------------------------------------------------------------------------------------------------------------------------------------------------------------------------------------------------------------------------------|
|    | 2009011710856  | US7054973; US20040093449 DE10331550 JP2004164544 TW200407784                                                                              | Computer system with <b>collapsible keyboard</b> and alternate display functions and processing method thereof | MITAC TECHNOLOGY<br>SHINKI KAGI KOFUN YUGENKOSHI | G06F-001/16<br>G06F-001/18<br>G06F-003/02<br>G06F-003/023<br>G06F-009/44<br>G06F-013/00<br>G06F-013/20<br>G06F-013/24 | (US20040093449)<br>A computer system with <b>collapsible keyboard</b> and alternate display functions. The computer system includes a main body which stores at least one application. A monitor and <b>collapsible keyboard</b> are coupled to the main body, the <b>keyboard</b> disposable in an open operating position and a folded position. A signal generating device is coupled to both the <b>collapsible keyboard</b> and the main body to generate a first <b>collapsible keyboard</b> and the main body to generate a first <b>collapsible keyboard</b> . | (US7054973)<br>What is claimed is:<br>1. A computer system, comprising a main body for storing at least an application; a monitor coupled to the main body; a keyboard coupled to the main body, disposable in at least an open operating position and a folded position, wherein, when disposed in the folded position, the keyboard covers a first <b>collapsible keyboard</b> and the main body to generate a first <b>collapsible keyboard</b> and the main body to generate a second <b>collapsible keyboard</b> .<br>(EP1510910) |
|    | 2009011304584  | WO2003104962 EP1510910 US20050105952 JP2004021416 JP2004013354 JP2004013343 JP2004013342 JP2004013340 JP2004013336 CN1856436 AU2003241978 | FOLDABLE KEYBOARD                                                                                              | BROTHER INDUSTRIES                               | B41J-005/08<br>G06F-001/16<br>G06F-003/02<br>G06F-015/02                                                              | A control section (62) is provided independent of a <b>keyboard</b> (1), and the control section (62) and a first <b>keyboard</b> unit (3) are connected to each other by an adjustable arm (67). The control section (62) can be placed at substantially the center position of the <b>keyboard</b> (1) because of the adjustable characteristics of the adjustable arm (67). This enables PDA73 connected to a connection member (64) of the control section (62) to be                                                                                              | 1. A foldable keyboard in which a rotational connecting part is provided between a first keyboard unit in which a plurality of key switches to be operated for a left hand are arranged and a second keyboard unit in which a plurality of key switches to be operated for a right hand are arranged so that both units are rotated about the rotational connecting part in a direction to come apart from each other into a horizontally arranged state.<br>(US6950038)                                                               |
|    | 20090110916458 | US6950038; US20030122690 TW-534390U                                                                                                       | Collapsible keyboard                                                                                           | DARFON ELECTRONICS                               | G06F-003/02<br>G06F-003/023<br>H03K-017/94<br>H03M-011/00                                                             | A <b>collapsible keyboard</b> . The <b>collapsible keyboard</b> includes a <b>keyboard</b> chassis, a right track frame, a right key set and a main key set. The right track frame is disposed on the <b>keyboard</b> chassis and slides rightward and leftward. The right track frame has a first sloped sliding groove. The left portion of the first sloped sliding groove is higher than the right portion of the first sloped sliding groove. The right key set is connected to the right track frame during the right track frame move                           | 1. A collapsible keyboard, comprising: a keyboard chassis; a right track frame slidably disposed on the keyboard chassis and sliding rightward and leftward, the right track frame having a first sloped sliding groove, wherein the left portion of the first sloped sliding groove is higher than the right portion of the first sloped sliding groove; a right key set movably connected to the right track frame during the right track frame move.<br>(US6256017)                                                                 |
|   | 20090090073237 | US6256017                                                                                                                                 | Collapsible keyboard and display mechanism for a computer system                                               |                                                  | G06F-001/16<br>G06F-003/02<br>G09G-005/00                                                                             | A <b>collapsible keyboard</b> and display mechanism for a computer system includes a <b>collapsible keyboard</b> having at least two independent <b>keyboard</b> sections and a first hinge device for enabling at least two of the <b>keyboard</b> sections to fold together in face to face relationship; and an independent display section disposed between the two <b>keyboard</b> sections in the collapsed condition.                                                                                                                                           | What is claimed is:<br>1. A collapsible keyboard and display mechanism for a computer system comprising:<br>a) A collapsible keyboard housing having at least two keyboard sections, said housing having a first hinge for enabling two of said keyboard sections to fold together in a face to face relationship, each of said keyboard sections having a                                                                                                                                                                             |
|  | 20090120271268 | US7375295; US20050224320 JP2005302016 TW-228739; TW200534314                                                                              | Collapsible keyboard                                                                                           | DAFANG ELECTRONICS<br>DARFON ELECTRONICS         | G06F-001/16<br>G06F-003/00<br>G06F-003/02<br>H01H-003/00<br>H01H-009/00<br>H01H-009/20<br>H01H-009/26<br>H01H-013/20  | A <b>collapsible keyboard</b> comprises a first key assembly, a second key assembly rotatably connected to the first key assembly and a third key assembly rotatably connected to the second key assembly. The first key assembly is located between the second and third key assemblies when the <b>collapsible keyboard</b> is in a collapsed mode, and the first key assembly, the second and third key assemblies are substantially located on the                                                                                                                 | What is claimed is:<br>1. A collapsible keyboard, comprising: a first key assembly; a second key assembly rotatably connected to the first key assembly; a third key assembly rotatably connected to the second key assembly, wherein the first key assembly is located between the second and third key assemblies when the <b>collapsible keyboard</b> is in a collapsed mode, and the first key                                                                                                                                     |
|  | 20090120378246 | US7153050; US20050258021 JP3112517U TW200539001                                                                                           | Collapsible keyboard                                                                                           | DARFON ELECTRONICS                               | B41J-011/00<br>B41J-011/56<br>B41J-029/06<br>G06F-003/02<br>H01H-009/00                                               | A <b>collapsible keyboard</b> comprises a connection part, a top cover pivoted to the connection part, a first key assembly connected to the connection part and movable between a first position and a second position, and a second key assembly pivoted to the first key assembly. The first key assembly is                                                                                                                                                                                                                                                        | What is claimed is:<br>1. A collapsible keyboard, comprising: a connection part comprising a hook; a top cover pivoted to the connection part; a first key assembly connected to the connection part and movable between a first position and a second position; and                                                                                                                                                                                                                                                                   |

Exemplo Relatório XLS

Pronto

# Ex. Questel Orbit

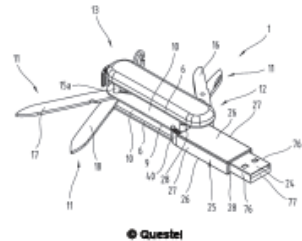
## Pocket tool US20050081302

|                                                                                                                                                                                                                                                                                                                                                                                                                                                                                                                                                                                                                                                                                                                                                                                                                                                                                                                                                                                                                                                                                                                                                                                                                                                                                                                                                                                                                                                                                                                                                                                                                                                                                                                                                                                                                                                                                                                                                                                                                                                                                                               |    |                                                                                                                                                                           |                  |                |    |          |                  |          |    |          |             |             |   |          |               |           |    |          |             |           |    |          |             |          |    |          |             |           |   |          |              |           |    |          |             |          |   |          |             |           |   |          |             |          |    |          |             |          |    |          |             |           |    |          |             |           |    |          |             |          |    |          |             |          |    |          |             |             |   |          |               |           |   |          |             |                |    |          |                  |           |    |          |             |              |    |          |                |               |   |          |                 |           |   |          |             |           |    |          |               |
|---------------------------------------------------------------------------------------------------------------------------------------------------------------------------------------------------------------------------------------------------------------------------------------------------------------------------------------------------------------------------------------------------------------------------------------------------------------------------------------------------------------------------------------------------------------------------------------------------------------------------------------------------------------------------------------------------------------------------------------------------------------------------------------------------------------------------------------------------------------------------------------------------------------------------------------------------------------------------------------------------------------------------------------------------------------------------------------------------------------------------------------------------------------------------------------------------------------------------------------------------------------------------------------------------------------------------------------------------------------------------------------------------------------------------------------------------------------------------------------------------------------------------------------------------------------------------------------------------------------------------------------------------------------------------------------------------------------------------------------------------------------------------------------------------------------------------------------------------------------------------------------------------------------------------------------------------------------------------------------------------------------------------------------------------------------------------------------------------------------|----|---------------------------------------------------------------------------------------------------------------------------------------------------------------------------|------------------|----------------|----|----------|------------------|----------|----|----------|-------------|-------------|---|----------|---------------|-----------|----|----------|-------------|-----------|----|----------|-------------|----------|----|----------|-------------|-----------|---|----------|--------------|-----------|----|----------|-------------|----------|---|----------|-------------|-----------|---|----------|-------------|----------|----|----------|-------------|----------|----|----------|-------------|-----------|----|----------|-------------|-----------|----|----------|-------------|----------|----|----------|-------------|----------|----|----------|-------------|-------------|---|----------|---------------|-----------|---|----------|-------------|----------------|----|----------|------------------|-----------|----|----------|-------------|--------------|----|----------|----------------|---------------|---|----------|-----------------|-----------|---|----------|-------------|-----------|----|----------|---------------|
| <p><b>Patent Assignee</b><br/>VICTORINORKS<br/>VICTORINOX</p> <p><b>Inventor</b><br/>ELSENER CARL</p> <p><b>International Patent Classification</b><br/>A61C-015/00;A61C-015/02;B25F;B25F-001/00;B25F-001/04;B26B;B26B-001/00;B26B-001/04;B26B-011/00;B26B-013/00;B26B-013/22;G06F;G06F-001/00;G06F-003/00;G06F-013/00;G06K-019/04;G06K-019/077;G11C;G11C-016/00</p> <p><b>US Patent Classification</b><br/>D07118000;D07170000</p>                                                                                                                                                                                                                                                                                                                                                                                                                                                                                                                                                                                                                                                                                                                                                                                                                                                                                                                                                                                                                                                                                                                                                                                                                                                                                                                                                                                                                                                                                                                                                                                                                                                                           |    | <p><b>Publication Information</b><br/>US2005081302 A1 20050421 [US20050081302]</p> <p><b>Priority Details</b><br/>2003AT-0001650 20031017<br/>2004AT-0001579 20040921</p> |                  |                |    |          |                  |          |    |          |             |             |   |          |               |           |    |          |             |           |    |          |             |          |    |          |             |           |   |          |              |           |    |          |             |          |   |          |             |           |   |          |             |          |    |          |             |          |    |          |             |           |    |          |             |           |    |          |             |          |    |          |             |          |    |          |             |             |   |          |               |           |   |          |             |                |    |          |                  |           |    |          |             |              |    |          |                |               |   |          |                 |           |   |          |             |           |    |          |               |
| <p><b>Patent family</b></p> <table border="1"> <tr> <td>DE102004048116</td> <td>B4</td> <td>20111208</td> <td>[DE102004048116]</td> </tr> <tr> <td>AT500428</td> <td>B1</td> <td>20110815</td> <td>[AT-500428]</td> </tr> <tr> <td>CN101890728</td> <td>A</td> <td>20101124</td> <td>[CN101890728]</td> </tr> <tr> <td>HK1073625</td> <td>A1</td> <td>20101119</td> <td>[HK1073625]</td> </tr> <tr> <td>FR2891179</td> <td>B1</td> <td>20100730</td> <td>[FR2891179]</td> </tr> <tr> <td>CH700252</td> <td>B1</td> <td>20100730</td> <td>[CH-700252]</td> </tr> <tr> <td>CN1628940</td> <td>B</td> <td>20100809</td> <td>[CN1628940B]</td> </tr> <tr> <td>FR2861007</td> <td>B1</td> <td>20090522</td> <td>[FR2861007]</td> </tr> <tr> <td>TW301790</td> <td>B</td> <td>20081011</td> <td>[TW-301790]</td> </tr> <tr> <td>GB2407056</td> <td>B</td> <td>20070912</td> <td>[GB2407056]</td> </tr> <tr> <td>AT500097</td> <td>B9</td> <td>20070815</td> <td>[AT-500097]</td> </tr> <tr> <td>AT500097</td> <td>B1</td> <td>20070715</td> <td>[AT-500097]</td> </tr> <tr> <td>FR2891179</td> <td>A1</td> <td>20070330</td> <td>[FR2891179]</td> </tr> <tr> <td>US7146567</td> <td>B2</td> <td>20051212</td> <td>[US7146567]</td> </tr> <tr> <td>AT500428</td> <td>A1</td> <td>20051215</td> <td>[AT-500428]</td> </tr> <tr> <td>AT500097</td> <td>A1</td> <td>20051015</td> <td>[AT-500097]</td> </tr> <tr> <td>TW200529993</td> <td>A</td> <td>20050916</td> <td>[TW200529993]</td> </tr> <tr> <td>CN1628940</td> <td>A</td> <td>20050622</td> <td>[CN1628940]</td> </tr> <tr> <td>DE102004048116</td> <td>A1</td> <td>20050512</td> <td>[DE102004048116]</td> </tr> <tr> <td>FR2861007</td> <td>A1</td> <td>20050422</td> <td>[FR2861007]</td> </tr> <tr> <td>US2005081302</td> <td>A1</td> <td>20050421</td> <td>[US2005081302]</td> </tr> <tr> <td>KR20050037399</td> <td>A</td> <td>20050421</td> <td>[KR20050037399]</td> </tr> <tr> <td>GB2407056</td> <td>A</td> <td>20050420</td> <td>[GB2407056]</td> </tr> <tr> <td>GB0422725</td> <td>D0</td> <td>20041117</td> <td>[GB200422725]</td> </tr> </table> |    |                                                                                                                                                                           |                  | DE102004048116 | B4 | 20111208 | [DE102004048116] | AT500428 | B1 | 20110815 | [AT-500428] | CN101890728 | A | 20101124 | [CN101890728] | HK1073625 | A1 | 20101119 | [HK1073625] | FR2891179 | B1 | 20100730 | [FR2891179] | CH700252 | B1 | 20100730 | [CH-700252] | CN1628940 | B | 20100809 | [CN1628940B] | FR2861007 | B1 | 20090522 | [FR2861007] | TW301790 | B | 20081011 | [TW-301790] | GB2407056 | B | 20070912 | [GB2407056] | AT500097 | B9 | 20070815 | [AT-500097] | AT500097 | B1 | 20070715 | [AT-500097] | FR2891179 | A1 | 20070330 | [FR2891179] | US7146567 | B2 | 20051212 | [US7146567] | AT500428 | A1 | 20051215 | [AT-500428] | AT500097 | A1 | 20051015 | [AT-500097] | TW200529993 | A | 20050916 | [TW200529993] | CN1628940 | A | 20050622 | [CN1628940] | DE102004048116 | A1 | 20050512 | [DE102004048116] | FR2861007 | A1 | 20050422 | [FR2861007] | US2005081302 | A1 | 20050421 | [US2005081302] | KR20050037399 | A | 20050421 | [KR20050037399] | GB2407056 | A | 20050420 | [GB2407056] | GB0422725 | D0 | 20041117 | [GB200422725] |
| DE102004048116                                                                                                                                                                                                                                                                                                                                                                                                                                                                                                                                                                                                                                                                                                                                                                                                                                                                                                                                                                                                                                                                                                                                                                                                                                                                                                                                                                                                                                                                                                                                                                                                                                                                                                                                                                                                                                                                                                                                                                                                                                                                                                | B4 | 20111208                                                                                                                                                                  | [DE102004048116] |                |    |          |                  |          |    |          |             |             |   |          |               |           |    |          |             |           |    |          |             |          |    |          |             |           |   |          |              |           |    |          |             |          |   |          |             |           |   |          |             |          |    |          |             |          |    |          |             |           |    |          |             |           |    |          |             |          |    |          |             |          |    |          |             |             |   |          |               |           |   |          |             |                |    |          |                  |           |    |          |             |              |    |          |                |               |   |          |                 |           |   |          |             |           |    |          |               |
| AT500428                                                                                                                                                                                                                                                                                                                                                                                                                                                                                                                                                                                                                                                                                                                                                                                                                                                                                                                                                                                                                                                                                                                                                                                                                                                                                                                                                                                                                                                                                                                                                                                                                                                                                                                                                                                                                                                                                                                                                                                                                                                                                                      | B1 | 20110815                                                                                                                                                                  | [AT-500428]      |                |    |          |                  |          |    |          |             |             |   |          |               |           |    |          |             |           |    |          |             |          |    |          |             |           |   |          |              |           |    |          |             |          |   |          |             |           |   |          |             |          |    |          |             |          |    |          |             |           |    |          |             |           |    |          |             |          |    |          |             |          |    |          |             |             |   |          |               |           |   |          |             |                |    |          |                  |           |    |          |             |              |    |          |                |               |   |          |                 |           |   |          |             |           |    |          |               |
| CN101890728                                                                                                                                                                                                                                                                                                                                                                                                                                                                                                                                                                                                                                                                                                                                                                                                                                                                                                                                                                                                                                                                                                                                                                                                                                                                                                                                                                                                                                                                                                                                                                                                                                                                                                                                                                                                                                                                                                                                                                                                                                                                                                   | A  | 20101124                                                                                                                                                                  | [CN101890728]    |                |    |          |                  |          |    |          |             |             |   |          |               |           |    |          |             |           |    |          |             |          |    |          |             |           |   |          |              |           |    |          |             |          |   |          |             |           |   |          |             |          |    |          |             |          |    |          |             |           |    |          |             |           |    |          |             |          |    |          |             |          |    |          |             |             |   |          |               |           |   |          |             |                |    |          |                  |           |    |          |             |              |    |          |                |               |   |          |                 |           |   |          |             |           |    |          |               |
| HK1073625                                                                                                                                                                                                                                                                                                                                                                                                                                                                                                                                                                                                                                                                                                                                                                                                                                                                                                                                                                                                                                                                                                                                                                                                                                                                                                                                                                                                                                                                                                                                                                                                                                                                                                                                                                                                                                                                                                                                                                                                                                                                                                     | A1 | 20101119                                                                                                                                                                  | [HK1073625]      |                |    |          |                  |          |    |          |             |             |   |          |               |           |    |          |             |           |    |          |             |          |    |          |             |           |   |          |              |           |    |          |             |          |   |          |             |           |   |          |             |          |    |          |             |          |    |          |             |           |    |          |             |           |    |          |             |          |    |          |             |          |    |          |             |             |   |          |               |           |   |          |             |                |    |          |                  |           |    |          |             |              |    |          |                |               |   |          |                 |           |   |          |             |           |    |          |               |
| FR2891179                                                                                                                                                                                                                                                                                                                                                                                                                                                                                                                                                                                                                                                                                                                                                                                                                                                                                                                                                                                                                                                                                                                                                                                                                                                                                                                                                                                                                                                                                                                                                                                                                                                                                                                                                                                                                                                                                                                                                                                                                                                                                                     | B1 | 20100730                                                                                                                                                                  | [FR2891179]      |                |    |          |                  |          |    |          |             |             |   |          |               |           |    |          |             |           |    |          |             |          |    |          |             |           |   |          |              |           |    |          |             |          |   |          |             |           |   |          |             |          |    |          |             |          |    |          |             |           |    |          |             |           |    |          |             |          |    |          |             |          |    |          |             |             |   |          |               |           |   |          |             |                |    |          |                  |           |    |          |             |              |    |          |                |               |   |          |                 |           |   |          |             |           |    |          |               |
| CH700252                                                                                                                                                                                                                                                                                                                                                                                                                                                                                                                                                                                                                                                                                                                                                                                                                                                                                                                                                                                                                                                                                                                                                                                                                                                                                                                                                                                                                                                                                                                                                                                                                                                                                                                                                                                                                                                                                                                                                                                                                                                                                                      | B1 | 20100730                                                                                                                                                                  | [CH-700252]      |                |    |          |                  |          |    |          |             |             |   |          |               |           |    |          |             |           |    |          |             |          |    |          |             |           |   |          |              |           |    |          |             |          |   |          |             |           |   |          |             |          |    |          |             |          |    |          |             |           |    |          |             |           |    |          |             |          |    |          |             |          |    |          |             |             |   |          |               |           |   |          |             |                |    |          |                  |           |    |          |             |              |    |          |                |               |   |          |                 |           |   |          |             |           |    |          |               |
| CN1628940                                                                                                                                                                                                                                                                                                                                                                                                                                                                                                                                                                                                                                                                                                                                                                                                                                                                                                                                                                                                                                                                                                                                                                                                                                                                                                                                                                                                                                                                                                                                                                                                                                                                                                                                                                                                                                                                                                                                                                                                                                                                                                     | B  | 20100809                                                                                                                                                                  | [CN1628940B]     |                |    |          |                  |          |    |          |             |             |   |          |               |           |    |          |             |           |    |          |             |          |    |          |             |           |   |          |              |           |    |          |             |          |   |          |             |           |   |          |             |          |    |          |             |          |    |          |             |           |    |          |             |           |    |          |             |          |    |          |             |          |    |          |             |             |   |          |               |           |   |          |             |                |    |          |                  |           |    |          |             |              |    |          |                |               |   |          |                 |           |   |          |             |           |    |          |               |
| FR2861007                                                                                                                                                                                                                                                                                                                                                                                                                                                                                                                                                                                                                                                                                                                                                                                                                                                                                                                                                                                                                                                                                                                                                                                                                                                                                                                                                                                                                                                                                                                                                                                                                                                                                                                                                                                                                                                                                                                                                                                                                                                                                                     | B1 | 20090522                                                                                                                                                                  | [FR2861007]      |                |    |          |                  |          |    |          |             |             |   |          |               |           |    |          |             |           |    |          |             |          |    |          |             |           |   |          |              |           |    |          |             |          |   |          |             |           |   |          |             |          |    |          |             |          |    |          |             |           |    |          |             |           |    |          |             |          |    |          |             |          |    |          |             |             |   |          |               |           |   |          |             |                |    |          |                  |           |    |          |             |              |    |          |                |               |   |          |                 |           |   |          |             |           |    |          |               |
| TW301790                                                                                                                                                                                                                                                                                                                                                                                                                                                                                                                                                                                                                                                                                                                                                                                                                                                                                                                                                                                                                                                                                                                                                                                                                                                                                                                                                                                                                                                                                                                                                                                                                                                                                                                                                                                                                                                                                                                                                                                                                                                                                                      | B  | 20081011                                                                                                                                                                  | [TW-301790]      |                |    |          |                  |          |    |          |             |             |   |          |               |           |    |          |             |           |    |          |             |          |    |          |             |           |   |          |              |           |    |          |             |          |   |          |             |           |   |          |             |          |    |          |             |          |    |          |             |           |    |          |             |           |    |          |             |          |    |          |             |          |    |          |             |             |   |          |               |           |   |          |             |                |    |          |                  |           |    |          |             |              |    |          |                |               |   |          |                 |           |   |          |             |           |    |          |               |
| GB2407056                                                                                                                                                                                                                                                                                                                                                                                                                                                                                                                                                                                                                                                                                                                                                                                                                                                                                                                                                                                                                                                                                                                                                                                                                                                                                                                                                                                                                                                                                                                                                                                                                                                                                                                                                                                                                                                                                                                                                                                                                                                                                                     | B  | 20070912                                                                                                                                                                  | [GB2407056]      |                |    |          |                  |          |    |          |             |             |   |          |               |           |    |          |             |           |    |          |             |          |    |          |             |           |   |          |              |           |    |          |             |          |   |          |             |           |   |          |             |          |    |          |             |          |    |          |             |           |    |          |             |           |    |          |             |          |    |          |             |          |    |          |             |             |   |          |               |           |   |          |             |                |    |          |                  |           |    |          |             |              |    |          |                |               |   |          |                 |           |   |          |             |           |    |          |               |
| AT500097                                                                                                                                                                                                                                                                                                                                                                                                                                                                                                                                                                                                                                                                                                                                                                                                                                                                                                                                                                                                                                                                                                                                                                                                                                                                                                                                                                                                                                                                                                                                                                                                                                                                                                                                                                                                                                                                                                                                                                                                                                                                                                      | B9 | 20070815                                                                                                                                                                  | [AT-500097]      |                |    |          |                  |          |    |          |             |             |   |          |               |           |    |          |             |           |    |          |             |          |    |          |             |           |   |          |              |           |    |          |             |          |   |          |             |           |   |          |             |          |    |          |             |          |    |          |             |           |    |          |             |           |    |          |             |          |    |          |             |          |    |          |             |             |   |          |               |           |   |          |             |                |    |          |                  |           |    |          |             |              |    |          |                |               |   |          |                 |           |   |          |             |           |    |          |               |
| AT500097                                                                                                                                                                                                                                                                                                                                                                                                                                                                                                                                                                                                                                                                                                                                                                                                                                                                                                                                                                                                                                                                                                                                                                                                                                                                                                                                                                                                                                                                                                                                                                                                                                                                                                                                                                                                                                                                                                                                                                                                                                                                                                      | B1 | 20070715                                                                                                                                                                  | [AT-500097]      |                |    |          |                  |          |    |          |             |             |   |          |               |           |    |          |             |           |    |          |             |          |    |          |             |           |   |          |              |           |    |          |             |          |   |          |             |           |   |          |             |          |    |          |             |          |    |          |             |           |    |          |             |           |    |          |             |          |    |          |             |          |    |          |             |             |   |          |               |           |   |          |             |                |    |          |                  |           |    |          |             |              |    |          |                |               |   |          |                 |           |   |          |             |           |    |          |               |
| FR2891179                                                                                                                                                                                                                                                                                                                                                                                                                                                                                                                                                                                                                                                                                                                                                                                                                                                                                                                                                                                                                                                                                                                                                                                                                                                                                                                                                                                                                                                                                                                                                                                                                                                                                                                                                                                                                                                                                                                                                                                                                                                                                                     | A1 | 20070330                                                                                                                                                                  | [FR2891179]      |                |    |          |                  |          |    |          |             |             |   |          |               |           |    |          |             |           |    |          |             |          |    |          |             |           |   |          |              |           |    |          |             |          |   |          |             |           |   |          |             |          |    |          |             |          |    |          |             |           |    |          |             |           |    |          |             |          |    |          |             |          |    |          |             |             |   |          |               |           |   |          |             |                |    |          |                  |           |    |          |             |              |    |          |                |               |   |          |                 |           |   |          |             |           |    |          |               |
| US7146567                                                                                                                                                                                                                                                                                                                                                                                                                                                                                                                                                                                                                                                                                                                                                                                                                                                                                                                                                                                                                                                                                                                                                                                                                                                                                                                                                                                                                                                                                                                                                                                                                                                                                                                                                                                                                                                                                                                                                                                                                                                                                                     | B2 | 20051212                                                                                                                                                                  | [US7146567]      |                |    |          |                  |          |    |          |             |             |   |          |               |           |    |          |             |           |    |          |             |          |    |          |             |           |   |          |              |           |    |          |             |          |   |          |             |           |   |          |             |          |    |          |             |          |    |          |             |           |    |          |             |           |    |          |             |          |    |          |             |          |    |          |             |             |   |          |               |           |   |          |             |                |    |          |                  |           |    |          |             |              |    |          |                |               |   |          |                 |           |   |          |             |           |    |          |               |
| AT500428                                                                                                                                                                                                                                                                                                                                                                                                                                                                                                                                                                                                                                                                                                                                                                                                                                                                                                                                                                                                                                                                                                                                                                                                                                                                                                                                                                                                                                                                                                                                                                                                                                                                                                                                                                                                                                                                                                                                                                                                                                                                                                      | A1 | 20051215                                                                                                                                                                  | [AT-500428]      |                |    |          |                  |          |    |          |             |             |   |          |               |           |    |          |             |           |    |          |             |          |    |          |             |           |   |          |              |           |    |          |             |          |   |          |             |           |   |          |             |          |    |          |             |          |    |          |             |           |    |          |             |           |    |          |             |          |    |          |             |          |    |          |             |             |   |          |               |           |   |          |             |                |    |          |                  |           |    |          |             |              |    |          |                |               |   |          |                 |           |   |          |             |           |    |          |               |
| AT500097                                                                                                                                                                                                                                                                                                                                                                                                                                                                                                                                                                                                                                                                                                                                                                                                                                                                                                                                                                                                                                                                                                                                                                                                                                                                                                                                                                                                                                                                                                                                                                                                                                                                                                                                                                                                                                                                                                                                                                                                                                                                                                      | A1 | 20051015                                                                                                                                                                  | [AT-500097]      |                |    |          |                  |          |    |          |             |             |   |          |               |           |    |          |             |           |    |          |             |          |    |          |             |           |   |          |              |           |    |          |             |          |   |          |             |           |   |          |             |          |    |          |             |          |    |          |             |           |    |          |             |           |    |          |             |          |    |          |             |          |    |          |             |             |   |          |               |           |   |          |             |                |    |          |                  |           |    |          |             |              |    |          |                |               |   |          |                 |           |   |          |             |           |    |          |               |
| TW200529993                                                                                                                                                                                                                                                                                                                                                                                                                                                                                                                                                                                                                                                                                                                                                                                                                                                                                                                                                                                                                                                                                                                                                                                                                                                                                                                                                                                                                                                                                                                                                                                                                                                                                                                                                                                                                                                                                                                                                                                                                                                                                                   | A  | 20050916                                                                                                                                                                  | [TW200529993]    |                |    |          |                  |          |    |          |             |             |   |          |               |           |    |          |             |           |    |          |             |          |    |          |             |           |   |          |              |           |    |          |             |          |   |          |             |           |   |          |             |          |    |          |             |          |    |          |             |           |    |          |             |           |    |          |             |          |    |          |             |          |    |          |             |             |   |          |               |           |   |          |             |                |    |          |                  |           |    |          |             |              |    |          |                |               |   |          |                 |           |   |          |             |           |    |          |               |
| CN1628940                                                                                                                                                                                                                                                                                                                                                                                                                                                                                                                                                                                                                                                                                                                                                                                                                                                                                                                                                                                                                                                                                                                                                                                                                                                                                                                                                                                                                                                                                                                                                                                                                                                                                                                                                                                                                                                                                                                                                                                                                                                                                                     | A  | 20050622                                                                                                                                                                  | [CN1628940]      |                |    |          |                  |          |    |          |             |             |   |          |               |           |    |          |             |           |    |          |             |          |    |          |             |           |   |          |              |           |    |          |             |          |   |          |             |           |   |          |             |          |    |          |             |          |    |          |             |           |    |          |             |           |    |          |             |          |    |          |             |          |    |          |             |             |   |          |               |           |   |          |             |                |    |          |                  |           |    |          |             |              |    |          |                |               |   |          |                 |           |   |          |             |           |    |          |               |
| DE102004048116                                                                                                                                                                                                                                                                                                                                                                                                                                                                                                                                                                                                                                                                                                                                                                                                                                                                                                                                                                                                                                                                                                                                                                                                                                                                                                                                                                                                                                                                                                                                                                                                                                                                                                                                                                                                                                                                                                                                                                                                                                                                                                | A1 | 20050512                                                                                                                                                                  | [DE102004048116] |                |    |          |                  |          |    |          |             |             |   |          |               |           |    |          |             |           |    |          |             |          |    |          |             |           |   |          |              |           |    |          |             |          |   |          |             |           |   |          |             |          |    |          |             |          |    |          |             |           |    |          |             |           |    |          |             |          |    |          |             |          |    |          |             |             |   |          |               |           |   |          |             |                |    |          |                  |           |    |          |             |              |    |          |                |               |   |          |                 |           |   |          |             |           |    |          |               |
| FR2861007                                                                                                                                                                                                                                                                                                                                                                                                                                                                                                                                                                                                                                                                                                                                                                                                                                                                                                                                                                                                                                                                                                                                                                                                                                                                                                                                                                                                                                                                                                                                                                                                                                                                                                                                                                                                                                                                                                                                                                                                                                                                                                     | A1 | 20050422                                                                                                                                                                  | [FR2861007]      |                |    |          |                  |          |    |          |             |             |   |          |               |           |    |          |             |           |    |          |             |          |    |          |             |           |   |          |              |           |    |          |             |          |   |          |             |           |   |          |             |          |    |          |             |          |    |          |             |           |    |          |             |           |    |          |             |          |    |          |             |          |    |          |             |             |   |          |               |           |   |          |             |                |    |          |                  |           |    |          |             |              |    |          |                |               |   |          |                 |           |   |          |             |           |    |          |               |
| US2005081302                                                                                                                                                                                                                                                                                                                                                                                                                                                                                                                                                                                                                                                                                                                                                                                                                                                                                                                                                                                                                                                                                                                                                                                                                                                                                                                                                                                                                                                                                                                                                                                                                                                                                                                                                                                                                                                                                                                                                                                                                                                                                                  | A1 | 20050421                                                                                                                                                                  | [US2005081302]   |                |    |          |                  |          |    |          |             |             |   |          |               |           |    |          |             |           |    |          |             |          |    |          |             |           |   |          |              |           |    |          |             |          |   |          |             |           |   |          |             |          |    |          |             |          |    |          |             |           |    |          |             |           |    |          |             |          |    |          |             |          |    |          |             |             |   |          |               |           |   |          |             |                |    |          |                  |           |    |          |             |              |    |          |                |               |   |          |                 |           |   |          |             |           |    |          |               |
| KR20050037399                                                                                                                                                                                                                                                                                                                                                                                                                                                                                                                                                                                                                                                                                                                                                                                                                                                                                                                                                                                                                                                                                                                                                                                                                                                                                                                                                                                                                                                                                                                                                                                                                                                                                                                                                                                                                                                                                                                                                                                                                                                                                                 | A  | 20050421                                                                                                                                                                  | [KR20050037399]  |                |    |          |                  |          |    |          |             |             |   |          |               |           |    |          |             |           |    |          |             |          |    |          |             |           |   |          |              |           |    |          |             |          |   |          |             |           |   |          |             |          |    |          |             |          |    |          |             |           |    |          |             |           |    |          |             |          |    |          |             |          |    |          |             |             |   |          |               |           |   |          |             |                |    |          |                  |           |    |          |             |              |    |          |                |               |   |          |                 |           |   |          |             |           |    |          |               |
| GB2407056                                                                                                                                                                                                                                                                                                                                                                                                                                                                                                                                                                                                                                                                                                                                                                                                                                                                                                                                                                                                                                                                                                                                                                                                                                                                                                                                                                                                                                                                                                                                                                                                                                                                                                                                                                                                                                                                                                                                                                                                                                                                                                     | A  | 20050420                                                                                                                                                                  | [GB2407056]      |                |    |          |                  |          |    |          |             |             |   |          |               |           |    |          |             |           |    |          |             |          |    |          |             |           |   |          |              |           |    |          |             |          |   |          |             |           |   |          |             |          |    |          |             |          |    |          |             |           |    |          |             |           |    |          |             |          |    |          |             |          |    |          |             |             |   |          |               |           |   |          |             |                |    |          |                  |           |    |          |             |              |    |          |                |               |   |          |                 |           |   |          |             |           |    |          |               |
| GB0422725                                                                                                                                                                                                                                                                                                                                                                                                                                                                                                                                                                                                                                                                                                                                                                                                                                                                                                                                                                                                                                                                                                                                                                                                                                                                                                                                                                                                                                                                                                                                                                                                                                                                                                                                                                                                                                                                                                                                                                                                                                                                                                     | D0 | 20041117                                                                                                                                                                  | [GB200422725]    |                |    |          |                  |          |    |          |             |             |   |          |               |           |    |          |             |           |    |          |             |          |    |          |             |           |   |          |              |           |    |          |             |          |   |          |             |           |   |          |             |          |    |          |             |          |    |          |             |           |    |          |             |           |    |          |             |          |    |          |             |          |    |          |             |             |   |          |               |           |   |          |             |                |    |          |                  |           |    |          |             |              |    |          |                |               |   |          |                 |           |   |          |             |           |    |          |               |



Arquivos exportáveis com famílias de patentes, incluindo hiperlinks para textos integrais, imagens e citações (mesmo para não assinantes)

**Abstract:**  
(US20050081302)  
The invention specifies a pocket tool, particularly a pocket knife ( 1 ) or plate-like tool card, comprising a housing ( 2 ) with at least one receiving area ( 10 ), and at least two functional components ( 11 ) movable from a storage position within the receiving area ( 10 ), into a working position outside of the receiving area ( 10 ). The first functional component ( 11 ) is designed as a tool, particularly a pair of scissors ( 16 ) or knife ( 1 ). The second functional component ( 11 ) has a support casing ( 25 ) and is equipped with a recordable and readable, nonvolatile memory, as well as with an interface ( 24 ). A releasable locking device and a longitudinal guide or pivot bearing are arranged between the support casing ( 25 ) of the second functional component ( 11 ) and the housing ( 2 ).



© Questel

# Pesquisa de Patentes

## Agregadores



- Dialog ([www.dialog.com](http://www.dialog.com)) \*
- Questel ([www.questel.com](http://www.questel.com))
- STN ([www.stn-international.de](http://www.stn-international.de)) \*
- Lexis Nexis ([www.lexisnexis.com](http://www.lexisnexis.com))
- Etc...

# Pesquisa de Patentes

## Meta- Agregadores



- Landon IP, Inc ([www.landon-ip.com](http://www.landon-ip.com))
- Cardinal IP, LLC ([www.cardinal-ip.com](http://www.cardinal-ip.com))
- Nerac, Inc ([www.nerac.com](http://www.nerac.com))
- CPA Global ([www.cpaglobal.com](http://www.cpaglobal.com))
- Etc...





# Uso Estratégico de Propriedade Intelectual e Informações Tecnológicas

## Foco no Setor Farmacêutico

- Agenda

- Propriedade Intelectual no contexto farmacêutico, com destaque a patentes
- Uso estratégico de patentes e informações patentárias
- Ferramentas e técnicas de busca e análise de informações tecnológicas
- Fontes, sistemas de busca e análise de informações com foco na área farmacêutica
- **Exemplo de mapeamento de segmento tecnológico**

# Uso Estratégico de Patentes & Informações Tecnológicas em Projetos de P&D

FIOCRUZ - Rio de Janeiro, RJ  
29 de abril de 2013

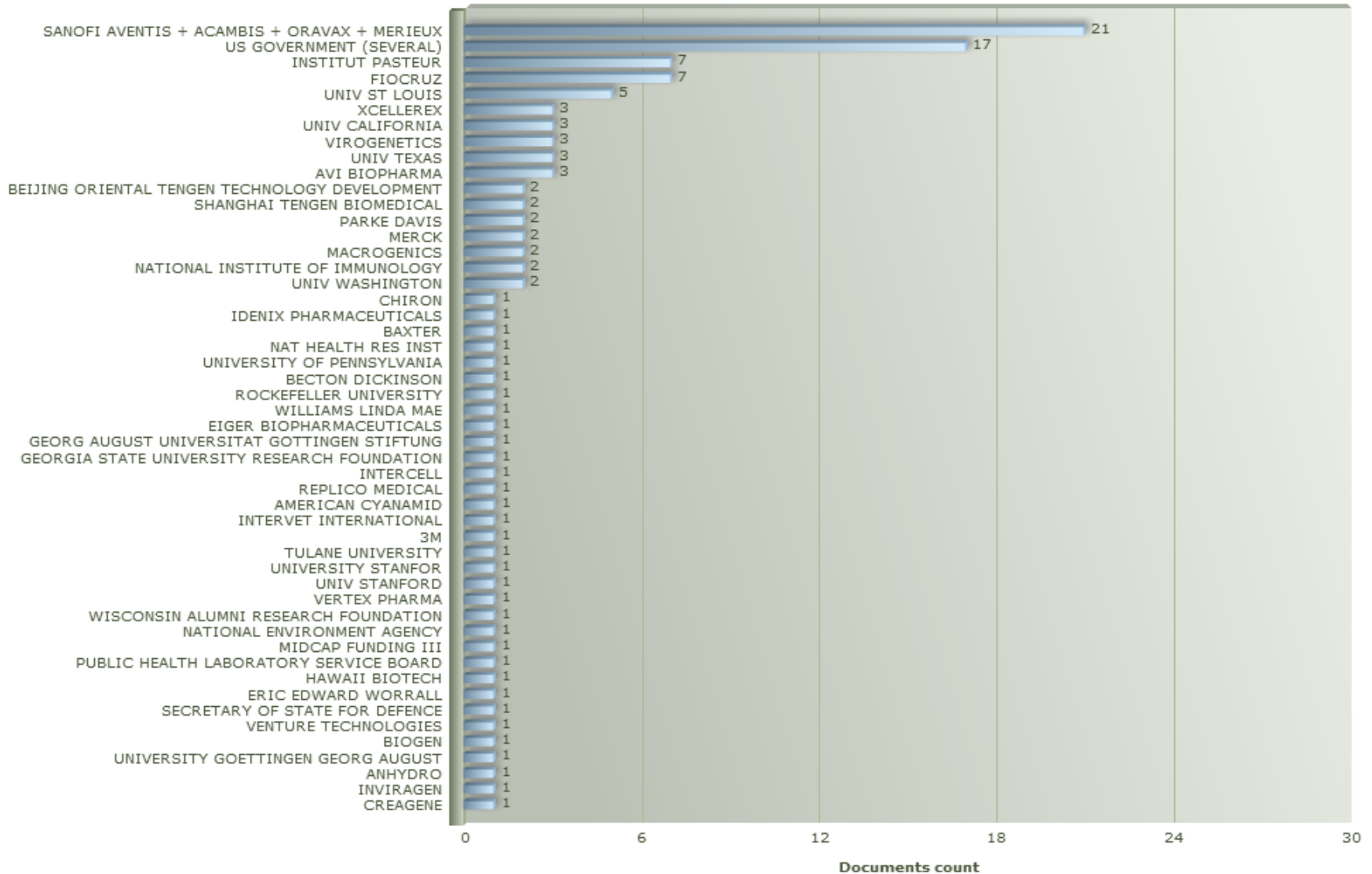
# Exemplo

Vacinas contra Febre Amarela e outros Flavivírus.

- Em relação a patentes de terceiros...
- Em relação a notificações de estudos clínicos...
- Em relação a publicações técnicas...
- Em relação a informações sobre esforços de P&D de terceiros...
- Em relação a notícias...
- Em relação a opiniões de experts...

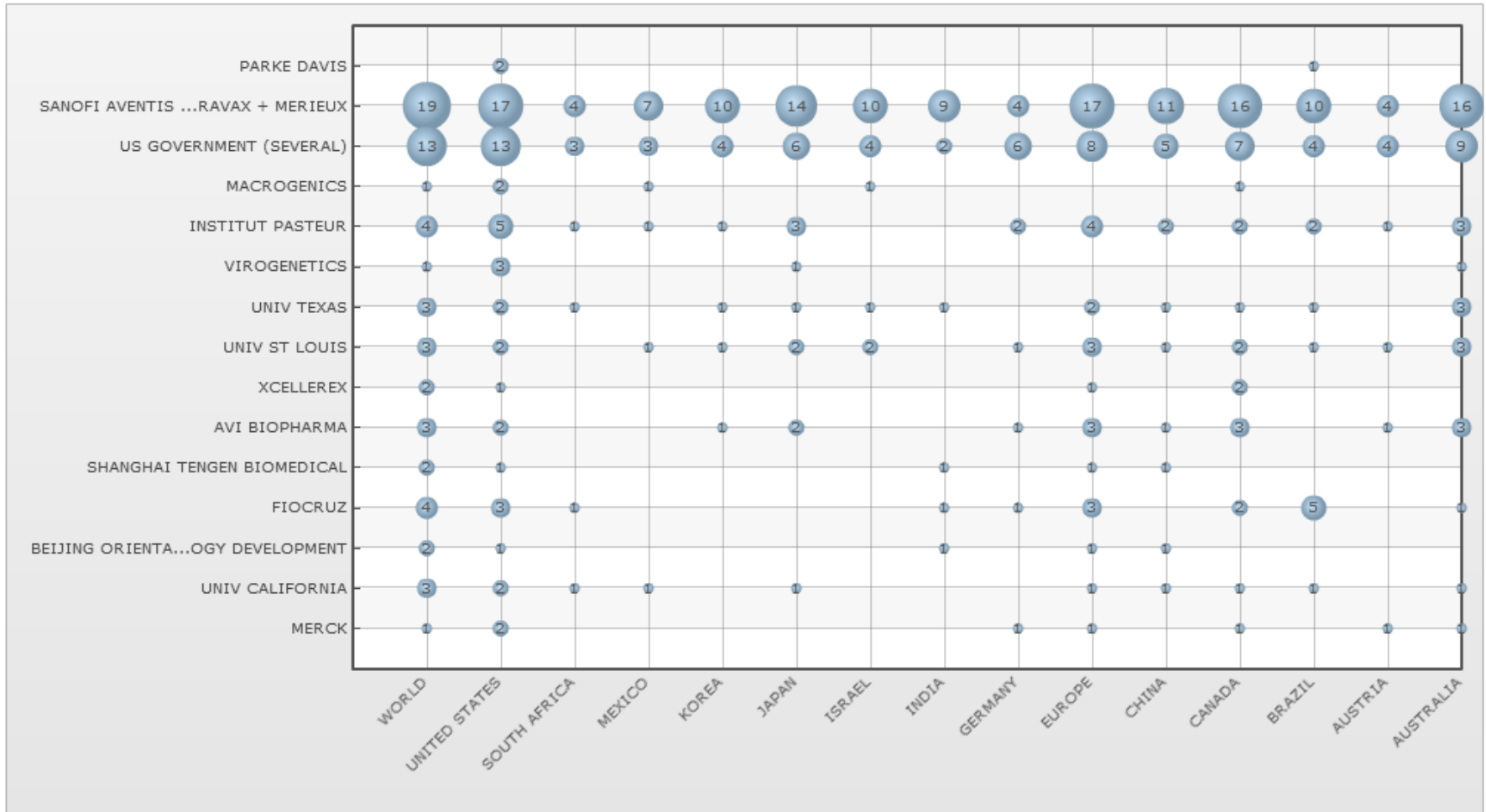
Em relação a patentes de terceiros...

# Febre Amarela maiores depositantes

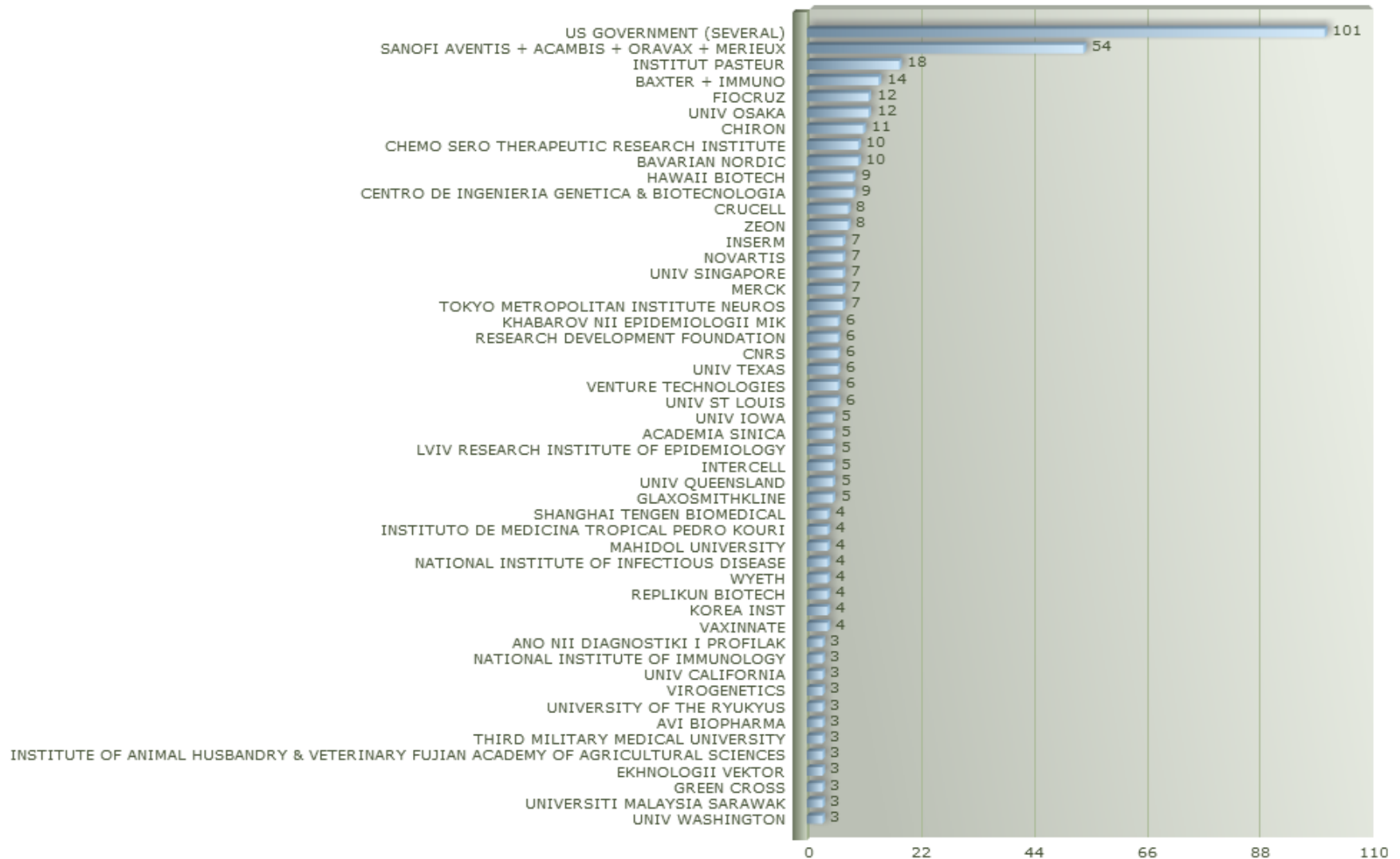




# Febre Amarela maiores depositantes cobertura geográfica



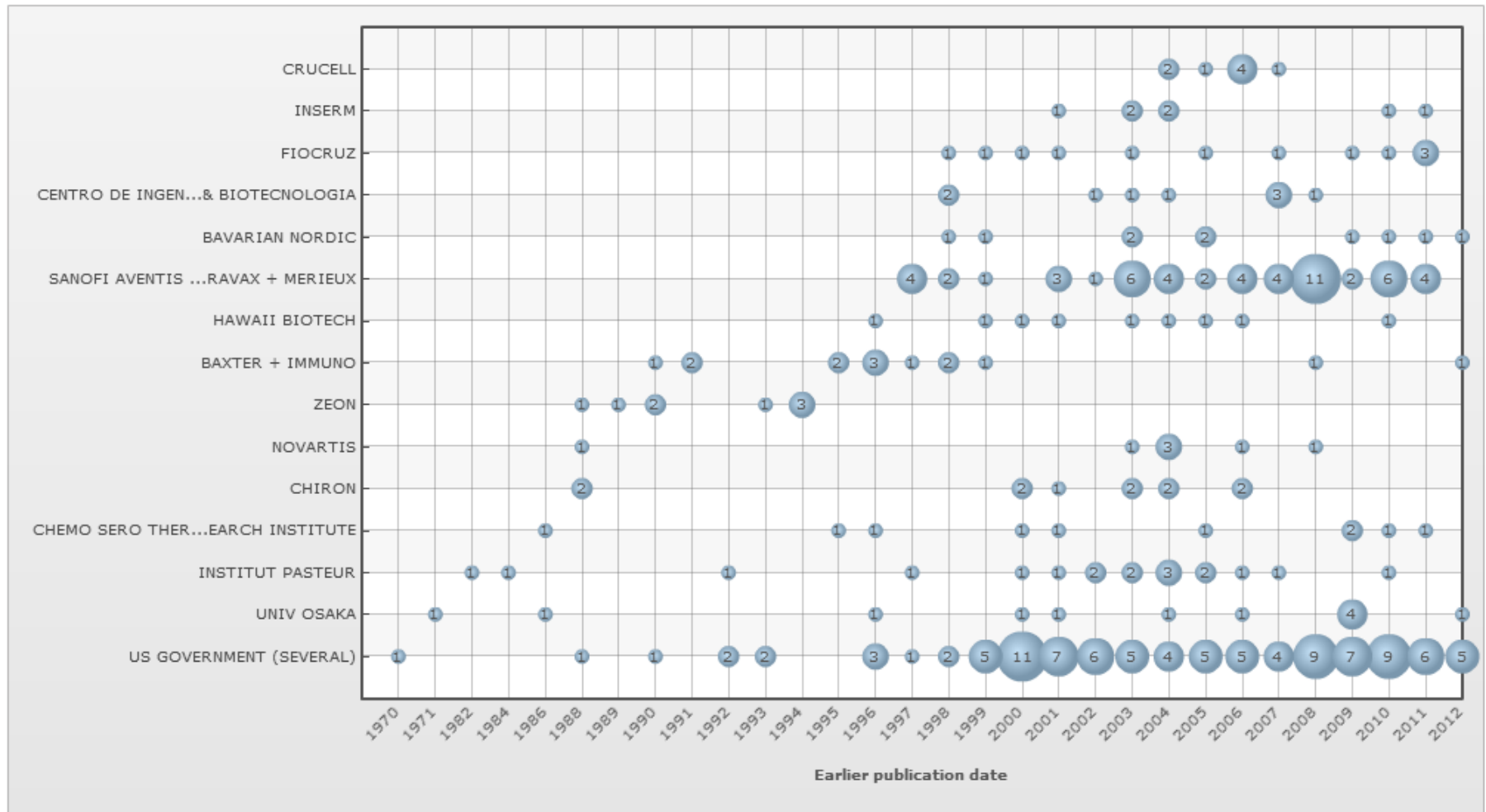
# Flavivirus maiores depositantes





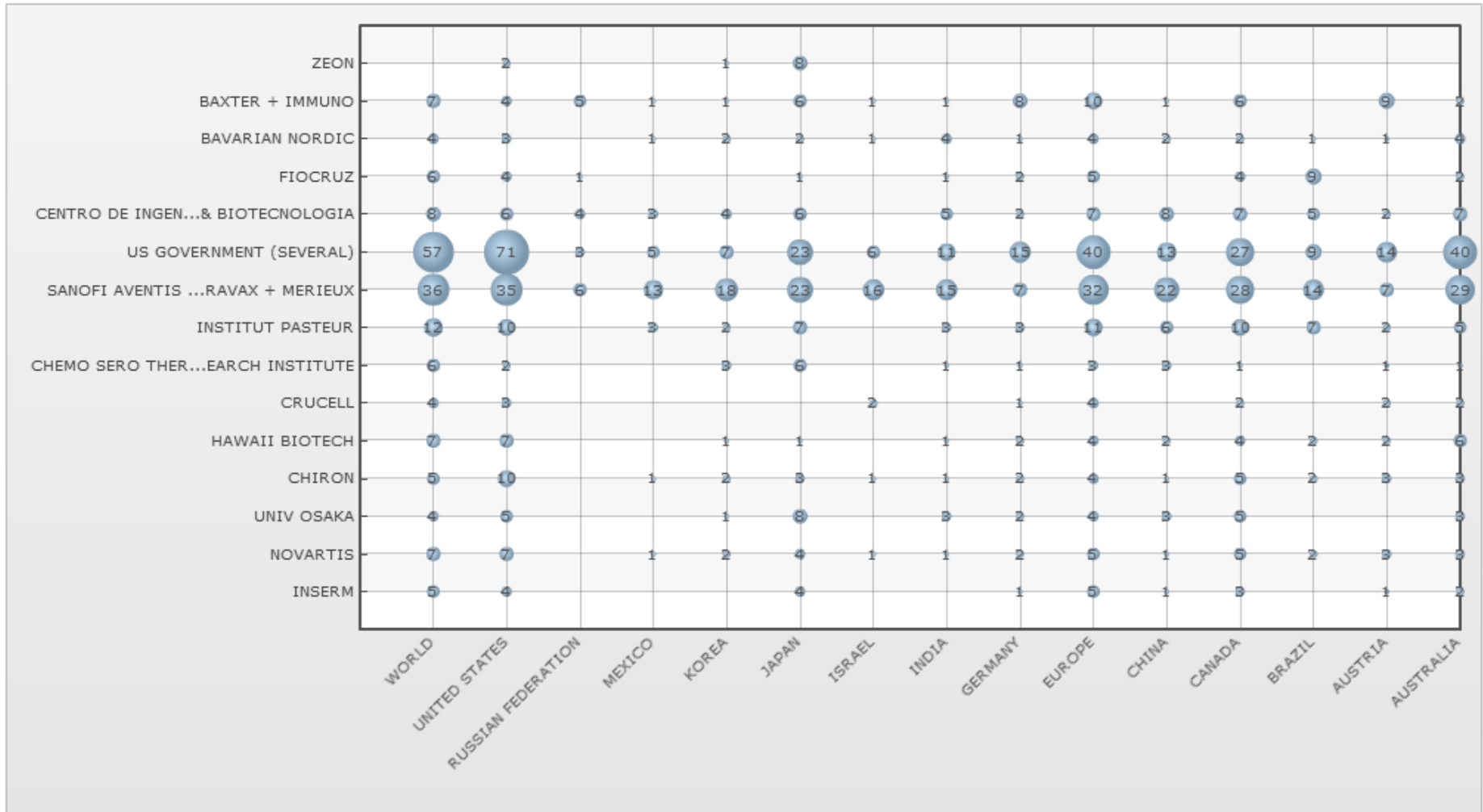
# Flavivirus maiores depositantes

## evolução temporal



# Flavivirus maiores depositantes

## cobertura geográfica



Em relação a notificações de estudos clínicos...

Arquivo | Página Inicial | Inserir | Layout da Página | Fórmulas | Dados | Revisão | Exibição

Calibri | 11 | A A

Fonte | Alinhamento | Número | Estilo | Células | Edição

Formatação Condicional | Inserir | Excluir | Formatar | Estilos de Célula

Classificar e Filtrar | Localizar e Selecionar | Share This File | WebEx

| Rank | Phases     | Start Year | Sponsor/Collaborators                                                                                                                                                                                     | Title                                                                                                                                                               | Recr |
|------|------------|------------|-----------------------------------------------------------------------------------------------------------------------------------------------------------------------------------------------------------|---------------------------------------------------------------------------------------------------------------------------------------------------------------------|------|
| 2    | 1          | 2011       | Emory University   Sri Edupuganti, MD MPH   University of California, Berkeley                                                                                                                            | Turnover of Antigen Specific Lymphocytes After Immunization With the Yellow Fever Vaccine                                                                           | Recr |
| 3    | 3 Phase 2  | 2011       | Sanofi-Aventis   Sanofi-Aventis                                                                                                                                                                           | Immune Response to Different Schedules of a Tetravalent Dengue Vaccine Given With or Without Yellow Fever Vaccine                                                   | Acti |
| 4    | 4 Phase 3  | 2011       | Sanofi-Aventis   Sanofi-Aventis                                                                                                                                                                           | Study of Yellow Fever Vaccine Administered With Tetravalent Dengue Vaccine in Healthy Toddlers                                                                      | Acti |
| 5    | 8 Phase 3  | 2011       | French National Institute for Health and Medical Research-French National Agency for Research on AIDS and Viral Hepatitis (Inserm-ANRS)   French National Agency for Research on AIDS and Viral Hepatitis | The Yellow Fever Vaccine Immunity in HIV Infected Patients : Development of New Assays for Virological and Immunological Monitoring in HIV Infected Patient.        | Com  |
| 8    | 16 Phase 3 | 2011       | Novartis   Novartis   Novartis Vaccines                                                                                                                                                                   | A Phase 3b, Randomized, Open-Label Study to Evaluate the Safety and Immunogenicity of Select Travel Vaccines When Administered Concomitantly With MenACWY in Adults | Acti |
| 9    | 6          | 2010       | Emory University   Emory University                                                                                                                                                                       | Immune Responses to Yellow Fever Vaccine                                                                                                                            | Enrc |
| 10   | 11 Phase 1 | 2010       | Xcellerex, Inc.   Xcellerex, Inc.                                                                                                                                                                         | Trial of Yellow Fever Inactivated Vaccine                                                                                                                           | Acti |
| 11   | 5          | 2008       | Emory University   Emory University                                                                                                                                                                       | Human Immune Responses to The Yellow Fever Virus Vaccine                                                                                                            | Recr |
| 16   | 18         | 2007       | Rockefeller University   Rockefeller University   Emory University                                                                                                                                        | Characterization of T Cell Responses Following Yellow Fever Virus Vaccination in Healthy Adults                                                                     | Com  |
| 17   | 2 Phase 1  | 2006       | Emory University   Emory University   Sanofi Pasteur MSD   Centers for Disease Control and Prevention                                                                                                     | Yellow Fever Virus Vaccine and Immune Globulin Study                                                                                                                | Com  |
| 20   | 9 Phase 2  | 2004       | Sanofi-Aventis   Sanofi-Aventis                                                                                                                                                                           | Study of Live Attenuated Japanese Encephalitis Vaccine (ChimeriVax®, C-JE) and Yellow Fever Vaccine (STAMARILÂ®)                                                    | Com  |

Arquivo | Página Inicial | Inserir | Layout da Página | Fórmulas | Dados | Revisão | Exibição

Normal | Layout da Página | Modos de Exibição Personalizados | Tela Inteira

Modos de Exibição de Pasta de Trabalho | Mostrar | Barra de Fórmulas | Linhas de Grade | Títulos

Zoom 100% | Zoom na Seleção

Nova Janela | Organizar Tudo | Congelar Painéis

Salvar Espaço de Trabalho | Alternar Janelas

Macros

| Rank | Start | Phase | Sponsor/Collaborators | Title                                                                                                                                                                                           | Recru                                                                                                                         | Study     | Cond    | Interv   | Enroll   | Start | Comp       | Prims     | URL       |                                                                                                       |
|------|-------|-------|-----------------------|-------------------------------------------------------------------------------------------------------------------------------------------------------------------------------------------------|-------------------------------------------------------------------------------------------------------------------------------|-----------|---------|----------|----------|-------|------------|-----------|-----------|-------------------------------------------------------------------------------------------------------|
| 2    | 7     | 2012  | Phase 2               | Sanofi-Aventis Sanofi-Aventis<br>U.S. Army Medical Research and Materiel Command U.S. Army Medical Research and Materiel Command GlaxoSmithKline Walter Reed Army Institute of Research (WRAIR) | Study of a Tetravalent Dengue Vaccine in Healthy Adult Subjects Aged 18 to 45 Years in India                                  | Active, n | No Resu | Dengue   | Biologic | 189   | March 20   | Decemb    | Decemb    | <a href="http://ClinicalTrials.gov/show/NCT01550289">http://ClinicalTrials.gov/show/NCT01550289</a>   |
| 3    | 47    | 2012  | Phase 1               | Sanofi-Aventis Sanofi-Aventis                                                                                                                                                                   | A Two-dose Primary Vaccination Study of a Tetravalent Dengue Virus Purified Inactivated Vaccine vs. Placebo in Healthy Adults | Not yet r | No Resu | Dengue f | Biologic | 100   | Septemb    | Decemb    | Decemb    | <a href="http://ClinicalTrials.gov/show/NCT01666652">http://ClinicalTrials.gov/show/NCT01666652</a>   |
| 4    | 48    | 2012  | Phase 1               | Merck Merck                                                                                                                                                                                     | Study of a Dengue Vaccine (V180) in Healthy Adults (V180-001 AM1)                                                             | Recruiti  | No Resu | Dengue   | Biologic | 120   | July 2012  | Decemb    | Decemb    | <a href="http://ClinicalTrials.gov/show/NCT01477580">http://ClinicalTrials.gov/show/NCT01477580</a>   |
| 6    | 3     | 2011  | Phase 2               | Sanofi-Aventis Sanofi-Aventis                                                                                                                                                                   | Immune Response to Different Schedules of a Tetravalent Dengue Vaccine Given With or Without Yellow Fever Vaccine             | Active, n | No Resu | Dengue   | Biologic | 330   | Decemb     | June 201  | June 201  | <a href="http://ClinicalTrials.gov/show/NCT01488890">http://ClinicalTrials.gov/show/NCT01488890</a>   |
| 7    | 9     | 2011  | Phase 3               | Sanofi-Aventis Sanofi-Aventis                                                                                                                                                                   | Study of a Novel Tetravalent Dengue Vaccine in Healthy Children Aged 2 to 14 Years in Asia                                    | Recruiti  | No Resu | Dengue   | Biologic | 10278 | June 201   | July 2014 | July 2014 | <a href="http://ClinicalTrials.gov/show/NCT01373281">http://ClinicalTrials.gov/show/NCT01373281</a>   |
| 8    | 10    | 2011  | Phase 3               | Sanofi-Aventis Sanofi-Aventis                                                                                                                                                                   | Study of a Novel Tetravalent Dengue Vaccine in Healthy Children and Adolescents Aged 9 to 16 Years in Latin America           | Active, n | No Resu | Dengue f | Biologic | 20875 | June 201   | August 2  | August 2  | <a href="http://ClinicalTrials.gov/show/NCT01374516">http://ClinicalTrials.gov/show/NCT01374516</a>   |
| 9    | 11    | 2011  | Phase 3               | Sanofi-Aventis Sanofi-Aventis                                                                                                                                                                   | Study of Yellow Fever Vaccine Administered With Tetravalent Dengue Vaccine in Healthy Toddlers                                | Active, n | No Resu | Dengue   | Biologic | 792   | Septemb    | January 2 | January 2 | <a href="http://ClinicalTrials.gov/show/NCT014136396">http://ClinicalTrials.gov/show/NCT014136396</a> |
| 10   | 12    | 2011  | Phase 3               | Sanofi-Aventis Sanofi-Aventis                                                                                                                                                                   | Study of a Booster Injection of Pentaxim®, a Vaccine Administered With Dengue Vaccine in Healthy Toddlers                     | Recruiti  | No Resu | Dengue   | Biologic | 732   | July 2011  | April 20  | April 20  | <a href="http://ClinicalTrials.gov/show/NCT01411241">http://ClinicalTrials.gov/show/NCT01411241</a>   |
| 11   | 18    | 2011  | Phase 1               | U.S. Army Medical Research and Materiel Command U.S. Army Medical Research and Materiel Command Vical Walter Reed Army Institute of Research (WRAIR) Naval Medical Research Center              | Evaluation of the Safety and the Ability of a DNA Vaccine to Protect Against Dengue Disease                                   | Active, n | No Resu | Dengue f | Biologic | 40    | Decemb     | Decemb    | Decemb    | <a href="http://ClinicalTrials.gov/show/NCT01502358">http://ClinicalTrials.gov/show/NCT01502358</a>   |
| 12   | 46    | 2011  | Phase 1               | U.S. Army Medical Research and Materiel Command U.S. Army Medical Research and Materiel Command                                                                                                 | Safety Study of a Vaccine (DENV-1 PIV) to Prevent Dengue Disease                                                              | Active, n | No Resu | Dengue f | Biologic | 20    | Decemb     | Septemb   | Septemb   | <a href="http://ClinicalTrials.gov/show/NCT01502735">http://ClinicalTrials.gov/show/NCT01502735</a>   |
| 14   | 13    | 2010  | Phase 2               | Sanofi-Aventis Sanofi-Aventis                                                                                                                                                                   | A Study of Dengue Vaccine in Healthy Toddlers Aged 12 to 15 Months in the                                                     | Active, n | No Resu | Dengue f | Biologic | 210   | January 2  | Septemb   | Septemb   | <a href="http://ClinicalTrials.gov/show/NCT01064141">http://ClinicalTrials.gov/show/NCT01064141</a>   |
| 15   | 14    | 2010  | Phase 3               | Sanofi-Aventis Sanofi-Aventis                                                                                                                                                                   | Study of a Tetravalent Dengue Vaccine in Healthy Adults in Australia                                                          | Active, n | No Resu | Dengue f | Biologic | 715   | October    | October   | Novemb    | <a href="http://ClinicalTrials.gov/show/NCT01134263">http://ClinicalTrials.gov/show/NCT01134263</a>   |
| 16   | 16    | 2010  | Phase 2               | Sanofi-Aventis Sanofi-Aventis                                                                                                                                                                   | Study of CYD Dengue Vaccine in Healthy Children and Adolescents in South America                                              | Active, n | No Resu | Dengue   | Biologic | 150   | August 2   | June 201  | Decemb    | <a href="http://ClinicalTrials.gov/show/NCT01187433">http://ClinicalTrials.gov/show/NCT01187433</a>   |
| 17   | 17    | 2010  | Phase 3               | Sanofi-Aventis Sanofi-Aventis                                                                                                                                                                   | Study of a Tetravalent Dengue Vaccine in Healthy Children Aged 2 to 11 Years in                                               | Active, n | No Resu | Dengue f | Biologic | 250   | Decemb     | January 2 | January 2 | <a href="http://ClinicalTrials.gov/show/NCT01254422">http://ClinicalTrials.gov/show/NCT01254422</a>   |
| 18   | 26    | 2010  | Phase 1               | National Institute of Allergy and Infectious Diseases (NIAID) National Institute of Allergy and Infectious Diseases (NIAID) Johns Hopkins Bloomberg School of Public Health                     | Evaluation of the Safety and Immune Response of Five Admixtures of a Tetravalent Dengue Virus Vaccine                         | Active, n | No Resu | Dengue   | Biologic | 140   | July 2010  |           |           | <a href="http://ClinicalTrials.gov/show/NCT01072786">http://ClinicalTrials.gov/show/NCT01072786</a>   |
| 19   | 32    | 2010  | Phase 1               | National Institute of Allergy and Infectious Diseases (NIAID) National Institute of Allergy and Infectious Diseases (NIAID)                                                                     | Tetravalent Chimeric Dengue Vaccine Trial                                                                                     | Comple    | No Resu | Dengue   | Drug; Pl | 72    | May 201    | April 20  | April 20  | <a href="http://ClinicalTrials.gov/show/NCT01110551">http://ClinicalTrials.gov/show/NCT01110551</a>   |
| 20   | 37    | 2010  | Phase 1               | National Institute of Allergy and Infectious Diseases (NIAID) National Institute of Allergy and Infectious Diseases (NIAID)                                                                     | Evaluation of the Safety and Immune Response to an Investigational Dengue Type 1 Vaccine                                      | Active, n | No Resu | Dengue   | Biologic | 18    | April 2010 |           |           | <a href="http://ClinicalTrials.gov/show/NCT01084291">http://ClinicalTrials.gov/show/NCT01084291</a>   |
| 21   | 38    | 2010  | Phase 1               | National Institute of Allergy and Infectious Diseases (NIAID) National Institute of Allergy and Infectious Diseases (NIAID)                                                                     | Safety and Immune Response to an Investigational Dengue Type 2 Vaccine                                                        | Comple    | No Resu | Dengue   | Biologic | 18    | February   | June 201  | June 201  | <a href="http://ClinicalTrials.gov/show/NCT01073306">http://ClinicalTrials.gov/show/NCT01073306</a>   |
| 22   | 45    | 2010  | Phase 1               | Inviragen Inc. Inviragen Inc.                                                                                                                                                                   | Safety and Immunogenicity Study to Assess DENVax, a Live Attenuated Tetravalent Vaccine for Prevention of Dengue Fever        | Active, n | No Resu | Dengue f | Biologic | 112   | October    | Septemb   | June 201  | <a href="http://ClinicalTrials.gov/show/NCT01224639">http://ClinicalTrials.gov/show/NCT01224639</a>   |

Arquivo | Página Inicial | Inserir | Layout da Página | Fórmulas | Dados | Revisão | Exibição

Normal | Visualização da Quebra de Página | Régua | Barra de Fórmulas | Nova Janela | Organizar Tudo | Congelar Painéis | Salvar Espaço de Trabalho | Alternar Janelas | Macros

Layout da Página | Modos de Exibição Personalizados | Tela Inteira | Linhas de Grade | Títulos | Zoom 100% | Zoom na Seleção | Janela

Modos de Exibição de Pasta de Trabalho | Mostrar

|    | A    | B          | D       | E                                                                                                                                                                               | F                                                                                                |
|----|------|------------|---------|---------------------------------------------------------------------------------------------------------------------------------------------------------------------------------|--------------------------------------------------------------------------------------------------|
| 1  | Rank | Start Year | Phases  | Sponsor/Collaborators                                                                                                                                                           | Title                                                                                            |
| 6  | 2    | 2008       | Phase 1 | Hawaii Biotech, Inc.   Hawaii Biotech, Inc.                                                                                                                                     | Safety Study of HBV-002 West Nile Vaccine in Healthy Adults                                      |
| 7  | 3    | 2008       | Phase 2 | Sanofi-Aventis   Sanofi-Aventis                                                                                                                                                 | Safety and Immunogenicity Study of ChimeriVax West Nile Vaccine in Healthy Adults                |
| 8  | 5    | 2008       | Phase 1 | National Institute of Allergy and Infectious Diseases (NIAID)   National Institute of Allergy and Infectious Diseases (NIAID)   Johns Hopkins Bloomberg School of Public Health | Safety of and Immune Response to a West Nile Virus Vaccine (WN/DEN4delta30) in Healthy Adults    |
| 12 | 6    | 2006       | Phase 1 | National Institutes of Health Clinical Center (CC)   National Institute of Allergy and Infectious Diseases (NIAID)                                                              | Phase I Study of West Nile Virus Vaccine                                                         |
| 15 | 1    | 2005       | Phase 2 | Sanofi-Aventis   Sanofi-Aventis                                                                                                                                                 | Safety and Immunogenicity of ChimeriVax-WN02 West Nile Vaccine in Healthy Adults                 |
| 16 | 4    | 2005       | Phase 1 | National Institute of Allergy and Infectious Diseases (NIAID)   National Institute of Allergy and Infectious Diseases (NIAID)   Johns Hopkins Bloomberg School of Public Health | Safety of and Immune Response to a West Nile Virus Vaccine (WN/DEN4-3'delta30) in Healthy Adults |
| 17 | 7    | 2005       | Phase 1 | National Institutes of Health Clinical Center (CC)   National Institute of Allergy and Infectious Diseases (NIAID)                                                              | Vaccine to Prevent West Nile Virus Disease                                                       |
| 20 |      |            |         |                                                                                                                                                                                 |                                                                                                  |
| 21 |      |            |         |                                                                                                                                                                                 |                                                                                                  |
| 22 |      |            |         |                                                                                                                                                                                 |                                                                                                  |
| 23 |      |            |         |                                                                                                                                                                                 |                                                                                                  |
| 24 |      |            |         |                                                                                                                                                                                 |                                                                                                  |



Arquivo | Página Inicial | Inserir | Layout da Página | Fórmulas | Dados | Revisão | Exibição

Régua     Barra de Fórmulas    Zoom 100%    Nova Janela    Organizar Tudo    Salvar Espaço de Trabalho    Alternar Janelas    Macros

Linhas de Grade     Títulos    Zoom na Seleção    Congelar Painéis    Janela    Macros

Modos de Exibição de Pasta de Trabalho    Mostrar    Zoom    Janela    Macros

| Rank | Start | Phase | Sponsor/Collaborators                                                                                                                                                                             | Title                                                                                                                                                                                                                                                                                        | Recru                                                                                                             | Study      | Condi     | Interv             |           |
|------|-------|-------|---------------------------------------------------------------------------------------------------------------------------------------------------------------------------------------------------|----------------------------------------------------------------------------------------------------------------------------------------------------------------------------------------------------------------------------------------------------------------------------------------------|-------------------------------------------------------------------------------------------------------------------|------------|-----------|--------------------|-----------|
| 1    |       |       | Indian Institute of Science Indian Institute of Science National Institute of Mental Health and Neurosciences University of Liverpool Program for Appropriate Technology in Health Wellcome Trust | A Prospective, Open Label Study of Human T Cell Responses to Live Attenuated Japanese Encephalitis Vaccine SA                                                                                                                                                                                | Recruiting                                                                                                        | No Result  | Japanese  | Biological         |           |
| 2    | 1     | 2012  | Phase 4                                                                                                                                                                                           | Novartis Novartis Vaccines                                                                                                                                                                                                                                                                   | Safety and Immunogenicity of 2 Different Vaccination Schedules of Rabies and Japanese Encephalitis Vaccines in H  | Not yet re | No Result | Rabies J           | Biologica |
| 3    | 18    | 2012  | Phase 3                                                                                                                                                                                           | Intercell AG Intercell AG                                                                                                                                                                                                                                                                    | Immune Response in IXIARO Batch JEV09L37 Recipients Before and After Revaccination                                | Not yet re | No Result | Japanese           | Biologica |
| 4    | 22    | 2012  | Phase 4                                                                                                                                                                                           | Program for Appropriate Technology in Health Program for Appropriate Technology in Health                                                                                                                                                                                                    | Lot-to-lot Consistency Trial of JE Live Attenuated SA 14-14-2 Vaccine                                             | Not yet re | No Result | Japanese           | Biologica |
| 5    | 45    | 2012  | Phase 4                                                                                                                                                                                           | Intercell AG Intercell AG                                                                                                                                                                                                                                                                    | Safety Surveillance After Immunization With IXIARO                                                                | Recruiting | No Result | Japanese           | Biologica |
| 7    | 24    | 2011  | Phase 3                                                                                                                                                                                           | Novartis Novartis Vaccines                                                                                                                                                                                                                                                                   | A Phase 3b, Randomized, Open-Label Study to Evaluate the Safety and Immunogenicity of Select Travel Vaccines v    | Active, n  | No Result | Meningo            | Biologica |
| 8    | 29    | 2011  | Phase 3                                                                                                                                                                                           | Sanofi-Aventis Sanofi-Aventis                                                                                                                                                                                                                                                                | Study of a Live Attenuated Japanese Encephalitis Chimeric Virus Vaccine (IMJJEVã, ç) Compared to CD, JEVAXã, ç i  | Active, n  | No Result | Japanese           | Biologica |
| 9    | 38    | 2011  | Phase 3                                                                                                                                                                                           | Mahidol University Pornthep Chanthavanich Liaoning Cheng Da Biotechnology Co., Ltd. China Bionet-Asia Co., Ltd. Thailand                                                                                                                                                                     | Immunogenicity and Safety of Inactivated Vero Cell Derived Japanese Encephalitis Vaccine in Thai Children         | Active, n  | No Result | Encepha            | Biologica |
| 11   | 7     | 2010  | Phase 3                                                                                                                                                                                           | Intercell AG Intercell AG                                                                                                                                                                                                                                                                    | Open-label, Randomized Study in a Pediatric Population in a JEV(Japanese Encephalitis Vaccine)-Endemic Country    | Active, n  | No Result | Japanese           | Biologica |
| 14   | 17    | 2010  | Phase 3                                                                                                                                                                                           | Boryung Pharmaceutical Co., Ltd Boryung Pharmaceutical Co., Ltd Seoul National University Hospital Gachon University Gil Medical Center Inha University Hospital Inje University Korea Cancer Center Hospital Samsung Medical Center The Catholic University of Korea Ewha Womans University | Clinical Trial to Assess the Immunogenicity and Safety of the Vero Cell-derived JE Vaccine in Korea               | Recruiting | No Result | Japanese           | Biologica |
| 15   | 31    | 2010  | Phase 3                                                                                                                                                                                           | Intercell AG Intercell AG                                                                                                                                                                                                                                                                    | Long Term Immunity and Safety Following Vaccination With the JEV IC51 (IXIARÔ, JESPECT) in Pediatric Popul        | Recruiting | No Result | Japanese           | Procedur  |
| 16   | 33    | 2010  | Phase 3                                                                                                                                                                                           | Sanofi-Aventis Sanofi-Aventis                                                                                                                                                                                                                                                                | A Study of Japanese Encephalitis Chimeric Virus Vaccine Compared With SA14-14-2 Vaccine in Infants and Toddlers   | Complete   | No Result | Encepha            | Biologica |
| 17   | 35    | 2010  | Phase 3                                                                                                                                                                                           | Sanofi-Aventis Sanofi-Aventis                                                                                                                                                                                                                                                                | Study of Japanese Encephalitis Chimeric Virus Vaccine Given With Measles-Mumps-Rubella Vaccine in Taiwanese T     | Active, n  | No Result | Japanese           | Biologica |
| 18   | 39    | 2010  | Phase 3                                                                                                                                                                                           | Sanofi-Aventis Sanofi-Aventis                                                                                                                                                                                                                                                                | Study of Japanese Encephalitis Chimeric Virus Vaccine (JE-CV) in Children Previously Immunized With JE-CV         | Active, n  | No Result | Japanese           | Biologica |
| 19   | 40    | 2010  | Phase 3                                                                                                                                                                                           | Intercell AG Intercell AG                                                                                                                                                                                                                                                                    | This is a Study to Assess the Safety and Immunogenicity of Ixiaro (IC51) in an Elderly Population                 | Complete   | No Result | Japanese           | Biologica |
| 20   | 47    | 2010  | Phase 4                                                                                                                                                                                           | Mennonite Christian Hospital Mennonite Christian Hospital                                                                                                                                                                                                                                    | Seroepidemiology of Japanese Encephalitis Virus Infection in Hualien, Taiwan                                      | Enrolling  | No Result | Japanese Enceph    |           |
| 21   | 48    | 2010  |                                                                                                                                                                                                   | Sanofi-Aventis Sanofi-Aventis                                                                                                                                                                                                                                                                | Long-term Follow-up of Immunogenicity of a Single Dose of Japanese Encephalitis Chimeric Virus Vaccine in Toddler | Enrolling  | No Result | Encephalitis Japar |           |
| 23   | 43    | 2009  | Phase 3                                                                                                                                                                                           | Sanofi-Aventis Sanofi-Aventis                                                                                                                                                                                                                                                                | Study of ChimeriVaxã, ç-Japanese Encephalitis Vaccine in Toddlers in Thailand and the Philippines                 | Complete   | No Result | Japanese           | Biologica |
| 24   | 2     | 2008  | Phase 3                                                                                                                                                                                           | Sanofi-Aventis Sanofi-Aventis                                                                                                                                                                                                                                                                | Study of ChimeriVaxã, ç-Japanese Encephalitis Vaccine in Toddlers in Thailand and the Philippines                 | Complete   | No Result | Japanese           | Biologica |

Em relação a publicações técnicas...



- Easy Search
- Advanced Search**
- CAS Number Search
- Patent Lookup

Review Saved Items

- + Help
- Session Cost
- Price List
- Preferences
- Search History
- + Cust. Support
- Comments
- Log Off**

Results for [Search Question:](#)

**yellow fever**

**Save** these search terms for future use

- 4617 answers in [BIOSIS](#)
- 499 answers in [BIOTECHNO](#)
- 2669 answers in [CABA](#)
- 2574 answers in [CAplus](#)
- 6926 answers in [EMBASE](#)
- 1031 answers in [ESBIOBASE](#)
- 2 answers in [KOSMET](#)
- 4611 answers in [MEDLINE](#)
- 1252 answers in [PASCAL](#)
- 3560 answers in [SCISEARCH](#)
- 27741 total hits

[\[Hide Database Info.\]](#)

Too many answers?

[Refine Your Search](#)

| <a href="#">Clear</a>       | Titles from BIOSIS in <a href="#">Most Recent Order</a>   <a href="#">Best Match Order</a>                                                              |
|-----------------------------|---------------------------------------------------------------------------------------------------------------------------------------------------------|
| <input type="checkbox"/> 1  | <a href="#">Proteomic Biomarkers for Ageing the Mosquito Aedes aegypti to Determine Risk of Pathogen Transmission.</a> [\$3.45]                         |
| <input type="checkbox"/> 2  | <a href="#">Electrophysiology of the isolated and perfused midgut of adult female <b>yellow fever</b> mosquitoes (Aedes aegypti).</a> [\$3.45]          |
| <input type="checkbox"/> 3  | <a href="#">Inhibition of strong midgut alkalinization in larval <b>yellow fever</b> mosquitoes (Aedes aegypti) with HEPES buffer.</a> [\$3.45]         |
| <input type="checkbox"/> 4  | <a href="#">The effect of targeted silencing of ferritin in the <b>yellow fever</b> mosquito, Aedes aegypti.</a> [\$3.45]                               |
| <input type="checkbox"/> 5  | <a href="#">Identification and characterization of a novel ferritin subunit from Aedes aegypti.</a> [\$3.45]                                            |
| <input type="checkbox"/> 6  | <a href="#">The effect of bacterial challenge on ferritin regulation in Aedes aegypti.</a> [\$3.45]                                                     |
| <input type="checkbox"/> 7  | <a href="#">PROBLEMS OF MEDICAL PARASITOLOGY.</a> [\$3.45]                                                                                              |
| <input type="checkbox"/> 8  | <a href="#">SCANNING ELECTRON MICROSCOPY OF EGGS OF SABETHES CYANEUS.</a> [\$3.45]                                                                      |
| <input type="checkbox"/> 9  | <a href="#">Active assessment of adverse events following <b>yellow fever</b> vaccination of persons aged 60 years and more.</a> [\$3.45]               |
| <input type="checkbox"/> 10 | <a href="#">The other half of the insect SLC4 family: a Cl/HCO3 anion exchanger from mosquito renal tubules.</a> [\$3.45]                               |
| <input type="checkbox"/> 11 | <a href="#">Evolution of resistance to satyrization through reproductive character displacement in populations of invasive dengue vectors.</a> [\$3.45] |

Results for [Search Question:](#)

**yellow fever AND Title: yellow fever and vaccin?**

**Save** these search terms for future use

- 428 answers in [BIOSIS](#)
- 73 answers in [BIOTECHNO](#)
- 286 answers in [CABA](#)
- 183 answers in [CAplus](#)
- 709 answers in [EMBASE](#)
- 169 answers in [ESBIOBASE](#)
- 0 answers in [KOSMET](#)
- 538 answers in [MEDLINE](#)
- 205 answers in [PASCAL](#)
- 383 answers in [SCISEARCH](#)
- 2974 total hits

[\[Hide Database Info.\]](#)

Too many answers?

[Refine Your Search](#)

[Show Duplicates](#)

| <input type="button" value="Clear"/> | Titles from BIOSIS in <a href="#">Most Recent Order</a>   <a href="#">Best Match Order</a>                                                                                                                |
|--------------------------------------|-----------------------------------------------------------------------------------------------------------------------------------------------------------------------------------------------------------|
| <input type="checkbox"/> 1           | <a href="#">Active assessment of adverse events following yellow fever vaccination of persons aged 60 years and more.</a> [\$3.45]                                                                        |
| <input type="checkbox"/> 2           | <a href="#">The Synergistic Effect of Combined Immunization with a DNA Vaccine and Chimeric Yellow Fever/Dengue Virus Leads to Strong Protection against Dengue.</a> [\$3.45]                             |
| <input type="checkbox"/> 3           | <a href="#">Safety and Immunogenicity of Yellow Fever Vaccine in Patients Receiving Systemic Corticosteroid Therapy: An Observational Cohort Study.</a> [\$3.45]                                          |
| <input type="checkbox"/> 4           | <a href="#">Identification of three H-2K(d) restricted CTL epitopes of NS4A and NS4B protein from Yellow fever 17D vaccine.</a> [\$3.45]                                                                  |
| <input type="checkbox"/> 5           | <a href="#">T-Cell Memory Responses Elicited by Yellow Fever Vaccine are Targeted to Overlapping Epitopes Containing Multiple HLA-I and -II Binding Motifs.</a> [\$3.45]                                  |
| <input type="checkbox"/> 6           | <a href="#">A Randomized, Double-Blind, Controlled Trial of the 17D Yellow Fever Virus Vaccine Given in Combination with Immune Globulin or Placebo: Comparative Viremia and Immunogenicity.</a> [\$3.45] |
| <input type="checkbox"/> 7           | <a href="#">17DD and 17D-213/77 Yellow Fever Substrains Trigger a Balanced Cytokine Profile in Primary Vaccinated Children.</a> [\$3.45]                                                                  |
| <input type="checkbox"/> 8           | <a href="#">Detection of Anti-Yellow Fever Virus Immunoglobulin M Antibodies at 3-4 Years Following Yellow Fever Vaccination.</a> [\$3.45]                                                                |
|                                      | <a href="#">Quality control for yellow fever vaccines used in the Brazilian National Immunization Program.</a>                                                                                            |

- Easy Search
- Advanced Search**
- CAS Number Search
- Patent Lookup

Review Saved Items

- + Help
- Session Cost
- Price List
- Preferences
- Search History
- + Cust. Support
- Comments
- Log Off**

Results for [Search Question:](#)

**yellow fever AND Title: yellow fever and vaccin?**

**Save** these search terms for future use

- 428 answers in [BIOSIS](#)
- 73 answers in [BIOTECHNO](#)
- 286 answers in [CABA](#)
- 183 answers in [CAplus](#)
- 709 answers in [EMBASE](#)
- 169 answers in [ESBIOBASE](#)
- 538 answers in [MEDLINE](#)
- 205 answers in [PASCAL](#)
- 383 answers in [SCISEARCH](#)
- 2974 total hits
- [\[Hide Database Info.\]](#)

Too many answers?

[Refine Your Search](#)

| <input type="button" value="Clear"/> | Titles from BIOSIS in Most Recent Order   <a href="#">Best Match Order</a>                                                                                                                                                                                           |
|--------------------------------------|----------------------------------------------------------------------------------------------------------------------------------------------------------------------------------------------------------------------------------------------------------------------|
| <input type="checkbox"/> 1           | <a href="#">Active assessment of adverse events following yellow fever vaccination of persons aged 60 years and more.</a> [\$3.45]<br>This answer is also in EMBASE, SCISEARCH                                                                                       |
| <input type="checkbox"/> 2           | <a href="#">The Synergistic Effect of Combined Immunization with a DNA Vaccine and Chimeric Yellow Fever/Dengue Virus Leads to Strong Protection against Dengue.</a> [\$3.45]                                                                                        |
| <input type="checkbox"/> 3           | <a href="#">Safety and Immunogenicity of Yellow Fever Vaccine in Patients Receiving Systemic Corticosteroid Therapy: An Observational Cohort Study.</a> [\$3.45]                                                                                                     |
| <input type="checkbox"/> 4           | <a href="#">Identification of three H-2K(d) restricted CTL epitopes of NS4A and NS4B protein from Yellow fever 17D vaccine.</a> [\$3.45]<br>This answer is also in CABA, CAPLUS, EMBASE, ESBIOBASE, MEDLINE, PASCAL, SCISEARCH                                       |
| <input type="checkbox"/> 5           | <a href="#">T-Cell Memory Responses Elicited by Yellow Fever Vaccine are Targeted to Overlapping Epitopes Containing Multiple HLA-I and -II Binding Motifs.</a> [\$3.45]                                                                                             |
| <input type="checkbox"/> 6           | <a href="#">A Randomized, Double-Blind, Controlled Trial of the 17D Yellow Fever Virus Vaccine Given in Combination with Immune Globulin or Placebo: Comparative Viremia and Immunogenicity.</a> [\$3.45]<br>This answer is also in CABA, EMBASE, MEDLINE, SCISEARCH |
| <input type="checkbox"/> 7           | <a href="#">17DD and 17D-213/77 Yellow Fever Substrains Trigger a Balanced Cytokine Profile in Primary Vaccinated Children.</a> [\$3.45]                                                                                                                             |
| <input type="checkbox"/> 8           | <a href="#">Detection of Anti-Yellow Fever Virus Immunoglobulin M Antibodies at 3-4 Years Following Yellow Fever Vaccination.</a> [\$3.45]                                                                                                                           |

- Easy Search
- Advanced Search**
- CAS Number Search
- Patent Lookup

Review Saved Items

- + Help
- Session Cost
- Price List
- Preferences
- Search History
- + Cust. Support
- Comments
- Log Off**

Em relação a informações sobre esforços de  
P&D de terceiros...

# Exemplo: Flavivirus (ADIS R&D Insight)

|    | A                                                                                                                                                                                                                                                                                             | B                                                                                                                                                                                                                       | C                   | E           |
|----|-----------------------------------------------------------------------------------------------------------------------------------------------------------------------------------------------------------------------------------------------------------------------------------------------|-------------------------------------------------------------------------------------------------------------------------------------------------------------------------------------------------------------------------|---------------------|-------------|
| 1  | PRODUCT NAME                                                                                                                                                                                                                                                                                  | COMPANY                                                                                                                                                                                                                 | HIGHEST DEVPT PHASE | DATABASE    |
| 12 | BERNA-YF; FLAVIMUN(R); YELLOW FEVER VACCINE - CRUCELL; attenuated yellow fever (YF) vaccine of the 17D strain                                                                                                                                                                                 | CRUCELL; BERNA BIOTECH                                                                                                                                                                                                  | 03. PREREGISTRATION | ADISINSIGHT |
| 13 | JAPANESE ENCEPHALITIS VACCINE - BORYUNG PHARMACEUTICAL; KD 287; KD-287; VERO CELL-DERIVED INACTIVATED JAPANESE ENCEPHALITIS VACCINE KD-287                                                                                                                                                    | BORYUNG PHARMACEUTICAL; BORYUNG                                                                                                                                                                                         | 04. PHASE III       | ADISINSIGHT |
| 14 | CHIMERIVAX-DENGUE; ATTENUATED; CHIMERIVAX(TM) TETRAVALENT DENGUE VACCINE; CHIMERIVAX(TM)-DEN1-4; CYD DENGUE VACCINE; DENGUE SEROTYPE 1; DENGUE VACCINE TETRAVALENT - SANOFI; LIVE; TETRAVALENT DENGUE VACCINE; 2; 3; 4 VIRUS VACCINE                                                          | SANOPI PASTEUR; ACAMBIS; INTERNATIONAL VACCINE INSTITUTE                                                                                                                                                                | 04. PHASE III       | ADISINSIGHT |
| 15 | JAPANESE ENCEPHALITIS VACCINE - BHARAT BIOTECH; JENVAC                                                                                                                                                                                                                                        | BHARAT BIOTECH                                                                                                                                                                                                          | 05. PHASE II        | ADISINSIGHT |
| 16 | CHIKUNGUNYA VIRUS VACCINE - INVIRAGEN; CHIKV - INVIRAGEN                                                                                                                                                                                                                                      | INVIRAGEN; SINGVAX; DUKE-NUS GRADUATE MEDICAL SCHOOL SINGAPORE                                                                                                                                                          | 05. PHASE II        | ADISINSIGHT |
| 17 | DENVAX(TM); NEEDLE-FREE DENGUE VACCINE; TETRAVALENT HYBRID DENGUE VIRUS VACCINE - INVIRAGEN/CDC/NIAID. DENVax is a tetravalent (four-component) combination vaccine containing the original attenuated DEN-2 PDK-53 vaccine and each of the chimeric vaccines (DEN-2/1, DEN-2/3 and DEN-2/4). | INVIRAGEN; CENTERS FOR DISEASE CONTROL AND PREVENTION; NATIONAL INSTITUTE OF ALLERGY AND INFECTIOUS DISEASES; NATIONAL INSTITUTES OF HEALTH (USA); DUKE-NUS GRADUATE MEDICAL SCHOOL SINGAPORE; PHARMAJET; UNIVERSITY OF | 05. PHASE II        | ADISINSIGHT |
| 18 | DENGUE VACCINE - GLAXOSMITHKLINE                                                                                                                                                                                                                                                              | WALTER REED ARMY INSTITUTE OF RESEARCH; GLAXOSMITHKLINE; OSWALDO CRUZ FOUNDATION                                                                                                                                        | 05. PHASE II        | ADISINSIGHT |
| 19 | HILTONOL(R); P.I.C.L.C.; POLY ICLC; POLY-ICLC; POLYINOSINIC POLYCYTIDYLIC ACID; POLYRIBOINOSINIC-POLYRIBOCYTIDYLIC ACID-POLYLYSINE CARBOXYMETHYLCELLULOSE; POLYRIBOINOSINIC-POLYRIBOCYTIDYLIC ACID                                                                                            | ONCOVIR; NATIONAL CANCER INSTITUTE (USA); UNIVERSITY OF PITTSBURGH                                                                                                                                                      | 05. PHASE II        | ADISINSIGHT |

Em relação a notícias...

Results for [Search Question:](#)

**vaccin? AND Publication Year: 2012-current AND yellow fever**

**Save** these search terms for future use

3 answers in [CBNB](#)

0 answers in [CIN](#)

3 total hits

[\[Hide Database Info.\]](#)

Too many answers?

[Refine Your Search](#)

|                                      |                                                                                                                                                                                                       |
|--------------------------------------|-------------------------------------------------------------------------------------------------------------------------------------------------------------------------------------------------------|
| <input type="button" value="Clear"/> | <b>Titles from CBNB in Most Recent Order</b>   <a href="#">Best Match Order</a>                                                                                                                       |
| <input type="checkbox"/> 1           | <a href="#">Successful <b>vaccine</b> developments at Themis Bioscience, Pasteur Institute Technology proves its effective potential.</a> [\$7.60]                                                    |
| <input type="checkbox"/> 2           | <a href="#">iBio selects proprietary recombinant C1 inhibitor for clinical development.</a> [\$7.60]                                                                                                  |
| <input type="checkbox"/> 3           | <a href="#">Sanofi Pasteur's Val-de-Reuil site increase <b>yellow fever vaccines</b> capacity.</a><br><a href="#">Sanofi Pasteur Val-de-Reuil monte en puissance contre la fièvre jaune.</a> [\$7.60] |

[Page 1]

Display Selection  Display Format  Display Style

[Display Answers](#)

- Easy Search
- Advanced Search**
- CAS Number Search
- Patent Lookup

Review Saved Items

- + Help
- Session Cost
- Price List
- Preferences
- Search History
- + Cust. Support
- Comments
- Log Off**



Results for [Search Question:](#)

**vaccin? AND Publication Year: 2012-current AND west nile**

**Save** these search terms for future use

7 answers in [CBNB](#)

0 answers in [CIN](#)

7 total hits

[\[Hide Database Info.\]](#)

Too many answers?

[Refine Your Search](#)

| <input type="button" value="Clear"/> | Titles from <a href="#">CBNB</a> in <b>Most Recent Order</b>   <a href="#">Best Match Order</a>                                                                                        |
|--------------------------------------|----------------------------------------------------------------------------------------------------------------------------------------------------------------------------------------|
| <input type="checkbox"/> 1           | <a href="#">Hawaii Biotech Gains Rights to <b>West Nile Vaccine</b> Technology From Merck.</a> [\$7.60]                                                                                |
| <input type="checkbox"/> 2           | <a href="#">Hawaii Biotech Inc gains rights to <b>West Nile vaccine</b> technology from Merck &amp; Co Inc.</a> [\$7.60]                                                               |
| <input type="checkbox"/> 3           | <a href="#">News and press releases: Committee for Medicinal Products for Veterinary Use (CVMP) Meeting of 9-11 Apr 2013: CVMP opinions on veterinary medicinal products.</a> [\$7.60] |
| <input type="checkbox"/> 4           | <a href="#">Pending EC decision: Equilis <b>West Nile</b>, inactivated chimeric Flavivirus strain YF-WN. Opinion date: 11-Apr-2013.</a> [\$7.60]                                       |
| <input type="checkbox"/> 5           | <a href="#">Successful <b>vaccine</b> developments at Themis Bioscience, Pasteur Institute Technology proves its effective potential.</a> [\$7.60]                                     |
| <input type="checkbox"/> 6           | <a href="#">News and press releases: Committee for Medicinal Products for Veterinary Use (CVMP) meeting of 8-10 Jan 2013: Pharmacovigilance.</a> [\$7.60]                              |
| <input type="checkbox"/> 7           | <a href="#">News and press releases: Committee for Medicinal Products for Veterinary Use (CVMP) meeting of 10-12 Jul 2012: Pharmacovigilance.</a> [\$7.60]                             |

[Page 1]

Display Selection  Display Format  Display Style

- Easy Search
- Advanced Search**
- CAS Number Search
- Patent Lookup

Review Saved Items

- + Help
- Session Cost
- Price List
- Preferences
- Search History
- + Cust. Support
- Comments
- Log Off**



Results for [Search Question:](#)

vaccin? AND Publication Year: 2012-current AND japanese encephalitis

 these search terms for future use
39 answers in [CBNB](#)0 answers in [CIN](#)

39 total hits

[\[Hide Database Info.\]](#)

Too many  
 answers?

| <input type="button" value="Clear"/> | Titles from <a href="#">CBNB</a> in <a href="#">Most Recent Order</a>   <a href="#">Best Match Order</a>                                                                                     |
|--------------------------------------|----------------------------------------------------------------------------------------------------------------------------------------------------------------------------------------------|
| <input type="checkbox"/> 1           | <a href="#">Successful <b>vaccine</b> developments at Themis Bioscience, Pasteur Institute Technology proves its effective potential.</a> [\$7.60]                                           |
| <input type="checkbox"/> 2           | <a href="#">Intercell AG announces 4Q and preliminary full year 2012 financial results and business update: Business highlights: Solid IXIARO/JESPECT sales growth performance.</a> [\$7.60] |
| <input type="checkbox"/> 3           | <a href="#">Indian Immunologicals to develop Chikungunya and <b>Japanese encephalitis vaccines</b>.</a> [\$7.60]                                                                             |
| <input type="checkbox"/> 4           | <a href="#">Intercell announces pediatric approval of its <b>Japanese Encephalitis vaccine</b> in Europe.</a> [\$7.60]                                                                       |
| <input type="checkbox"/> 5           | <a href="#">Vabiotech licenses Inviragen technology for <b>Japanese encephalitis vaccine</b> production.</a> [\$7.60]                                                                        |
| <input type="checkbox"/> 6           | <a href="#">Bharat Bio to launch <b>Japanese encephalitis vaccine</b> by Apr 2013.</a> [\$7.60]                                                                                              |
| <input type="checkbox"/> 7           | <a href="#">Proposed Merger of Equals between Vivalis and Intercell - Creation of a European biotech leader in <b>vaccines</b> and antibodies.</a> [\$7.60]                                  |
| <input type="checkbox"/> 8           | <a href="#">Intercell receives CHMP positive opinion for the pediatric indication of its <b>Japanese Encephalitis vaccine</b> in Europe.</a> [\$7.60]                                        |
| <input type="checkbox"/> 9           | <a href="#">JEEV Infusing life into humanity.</a> [\$7.60]                                                                                                                                   |
| <input type="checkbox"/> 10          | <a href="#">Vivalis to buy Intercell AG in European biotech merger for \$174 M.</a> [\$7.60]                                                                                                 |
| <input type="checkbox"/> 11          | <a href="#"><b>Vaccine</b> producer Intercell and Vivalis merge. Impfstoffhersteller Intercell und Vivalis fusionieren.</a> [\$7.60]                                                         |
| <input type="checkbox"/> 12          | <a href="#">Sanofi Pasteur launches next generation <b>Japanese encephalitis vaccine</b> in Thailand.</a> [\$7.60]                                                                           |
| <input type="checkbox"/> 13          | <a href="#">Sanofi Pasteur launches <b>Japanese encephalitis vaccine</b> in Australia.</a> [\$7.60]                                                                                          |
| <input type="checkbox"/> 14          | <a href="#">Sanofi Pasteur launches Imojev first single-dose <b>vaccine</b> against <b>Japanese encephalitis</b> in</a>                                                                      |

Results for [Search Question](#):

vaccin? AND Publication Year: 2012-current AND dengue

**Save** these search terms for future use23 answers in [CBNB](#)1 answers in [CIN](#)

24 total hits

[\[Hide Database Info.\]](#)Too many  
answers?[Refine Your Search](#)

| <input type="button" value="Clear"/> | Titles from <a href="#">CBNB</a> in <b>Most Recent Order</b>   <a href="#">Best Match Order</a>                                                                                         |
|--------------------------------------|-----------------------------------------------------------------------------------------------------------------------------------------------------------------------------------------|
| <input type="checkbox"/> 1           | <a href="#">Participation in Global Health Innovative Technology Fund (GHIT Fund).</a> [\$7.60]                                                                                         |
| <input type="checkbox"/> 2           | <a href="#">A*STAR: Australia and Singapore join forces to tackle emerging infectious diseases.</a> [\$7.60]                                                                            |
| <input type="checkbox"/> 3           | <a href="#">VaxInnate awarded US grant to develop recombinant <b>vaccine</b> for <b>dengue</b>.</a> [\$7.60]                                                                            |
| <input type="checkbox"/> 4           | <a href="#">Successful <b>vaccine</b> developments at Themis Bioscience, Pasteur Institute Technology proves its effective potential.</a> [\$7.60]                                      |
| <input type="checkbox"/> 5           | <a href="#">Nagasaki University and Astellas launch collaborative research for screening new anti-<b>dengue</b> virus drugs for neglected tropical diseases.</a> [\$7.60]               |
| <input type="checkbox"/> 6           | <a href="#">European <b>vaccines</b> market poised for growth.</a> [\$7.60]                                                                                                             |
| <input type="checkbox"/> 7           | <a href="#">Dengue fever <b>vaccine</b> proves effective.</a> [\$7.60]<br>This answer is also in <a href="#">CIN</a>                                                                    |
| <input type="checkbox"/> 8           | <a href="#">Sanofi Pasteur obtains mixed results for <b>dengue vaccine</b> trial.</a><br><a href="#">Vaccins: resultats mitigés de Sanofi Pasteur contre la <b>dengue</b>.</a> [\$7.60] |
| <input type="checkbox"/> 9           | <a href="#">Dengue weapons.</a> [\$7.60]                                                                                                                                                |
| <input type="checkbox"/> 10          | <a href="#">Sanofi Pasteur announces publication in The Lancet of world's first efficacy results for its <b>dengue vaccine</b> candidate.</a> [\$7.60]                                  |
| <input type="checkbox"/> 11          | <a href="#">Sanofi (France) <b>dengue vaccine</b> less effective than hoped.</a> [\$7.60]                                                                                               |
| <input type="checkbox"/> 12          | <a href="#">Sanofi (France)'s world first <b>dengue vaccine</b> beats 3 virus strains.</a> [\$7.60]                                                                                     |

Easy Search  
**Advanced Search**  
 CAS Number Search  
 Patent Lookup

Review Saved Items

+ Help  
 Session Cost  
 Price List  
 Preferences  
 Search History  
 + Cust. Support  
 Comments  
**Log Off**

Easy Search

**Advanced Search**

CAS Number Search

Patent Lookup

Review Saved Items

+ Help

Session Cost

Price List

Preferences

Search History

+ Cust. Support

Comments

**Log Off**

|                             |                                                                                                                                                                                                                   |
|-----------------------------|-------------------------------------------------------------------------------------------------------------------------------------------------------------------------------------------------------------------|
| <input type="checkbox"/> 8  | <a href="#">Sanofi Pasteur obtains mixed results for <b>dengue vaccine</b> trial.</a><br><a href="#">Vaccins</a> : resultats mitiges de Sanofi Pasteur contre la <b>dengue</b> . [\$7.60]                         |
| <input type="checkbox"/> 9  | <a href="#">Dengue weapons.</a> [\$7.60]                                                                                                                                                                          |
| <input type="checkbox"/> 10 | <a href="#">Sanofi Pasteur announces publication in The Lancet of world's first efficacy results for its <b>dengue vaccine</b> candidate.</a> [\$7.60]                                                            |
| <input type="checkbox"/> 11 | <a href="#">Sanofi (France) <b>dengue vaccine</b> less effective than hoped.</a> [\$7.60]                                                                                                                         |
| <input type="checkbox"/> 12 | <a href="#">Sanofi (France)'s world first <b>dengue vaccine</b> beats 3 virus strains.</a> [\$7.60]                                                                                                               |
| <input type="checkbox"/> 13 | <a href="#">Sanofi (France)'s world first <b>dengue vaccine</b> beats 3 virus strains.</a> [\$7.60]                                                                                                               |
| <input type="checkbox"/> 14 | <a href="#">Panacea Biotec: Hard hit by WHO.</a> [\$7.60]                                                                                                                                                         |
| <input type="checkbox"/> 15 | <a href="#">BioDiem licenses hepatitis <b>vaccine</b> tech from UC</a> [\$7.60]                                                                                                                                   |
| <input type="checkbox"/> 16 | <a href="#">BioDiem sets sights on <b>dengue</b> fever <b>vaccine</b>.</a> [\$7.60]                                                                                                                               |
| <input type="checkbox"/> 17 | <a href="#">BioDiem closes <b>dengue</b> fever deal.</a> [\$7.60]                                                                                                                                                 |
| <input type="checkbox"/> 18 | <a href="#">BioDiem, ANU sign <b>Dengue</b> fever <b>vaccine</b> technology agreement.</a> [\$7.60]                                                                                                               |
| <input type="checkbox"/> 19 | <a href="#">BioDiem Ltd signs full agreement with Australian National University for <b>dengue</b> fever <b>vaccine</b> technology.</a> [\$7.60]                                                                  |
| <input type="checkbox"/> 20 | <a href="#">Australian National University to Grant BioDiem Ltd exclusive licence for novel technology to target infectious diseases.</a> [\$7.60]                                                                |
| <input type="checkbox"/> 21 | <a href="#">BioNet shifts strategy to new multipurpose <b>vaccines</b>.</a> [\$7.60]                                                                                                                              |
| <input type="checkbox"/> 22 | <a href="#">MNCs circle, descend on Indian <b>vaccine</b> market: Introduction of immunisation programme and aggressive product rollout by domestic firms are prompting MNCs to strengthen presence.</a> [\$7.60] |
| <input type="checkbox"/> 23 | <a href="#">US Navy advances <b>dengue</b> DNA <b>vaccine</b> using Vical Inc's vaxfectin adjuvant.</a> [\$7.60]                                                                                                  |
|                             | <b>Titles from CIN in Most Recent Order</b>                                                                                                                                                                       |
| <input type="checkbox"/> 24 | <a href="#">Dengue fever <b>vaccine</b> proves effective</a> [\$6.10]<br>This answer is also in CBNB                                                                                                              |

[Page 1]

Display Selection  ▾Display Format  ▾Display Style  ▾**Display Answers**



US Navy Advances Dengue DNA Vaccine Using Vical Inc Vaxfectin Adjuvant



suzuki@marcelinosuzuki.com ▾

Web Images Maps Shopping More ▾ Search tools



About 1,480 results (0.15 seconds)

Ad related to **US Navy Advances Dengue DNA Vaccine Using ...** ⓘ

**Dengue Antigen - Microbix.com**

[www.microbix.com/dengue](http://www.microbix.com/dengue)

High Quality Native Dengue Antigens Fast Shipping! Expert Virologists.

**US Navy Advances Dengue DNA Vaccine Using Vical's ... - Vical, I...**

[www.vical.com/.../US-Navy-Advances-Dengue-DNA-Vaccine-Using-Vic...](http://www.vical.com/.../US-Navy-Advances-Dengue-DNA-Vaccine-Using-Vic...) ▾

Mar 5, 2012 – U.S. Navy Advances Dengue DNA Vaccine Using Vical's ... dengue DNA vaccine formulated with the company's Vaxfectin® adjuvant. The trial ...

**US Navy Advances Dengue DNA Vaccine Using Vical ... - Reuters**

[www.reuters.com/finance/stocks/VICL.O/key-developments/.../2494421](http://www.reuters.com/finance/stocks/VICL.O/key-developments/.../2494421) ▾

Mar 5, 2012 – U.S. Navy Advances Dengue DNA Vaccine Using Vical Inc's ... dengue DNA vaccine formulated with the company's Vaxfectin adjuvant.

**Vical Inc (VICL.O) Key Developments | Reuters.com**

[www.reuters.com/finance/stocks/VICL.O/key-developments](http://www.reuters.com/finance/stocks/VICL.O/key-developments) ▾

U.S. Navy Advances Dengue DNA Vaccine Using Vical Inc's Vaxfectin Adjuvant Monday, 5 Mar 2012 06:30am EST. Vical Inc announced that the Naval Medical ...

**Vical Says U.S. Navy Advances Dengue DNA Vaccine Using Its ...**

[www.rttnews.com/.../vical-says-u-s-navy-advances-dengue-dna-vaccine-...](http://www.rttnews.com/.../vical-says-u-s-navy-advances-dengue-dna-vaccine-...) ▾

Mar 5, 2012 – Vical Inc. (VICL) said the Naval Medical Research Center, or NMRC, has ... Vical Says U.S. Navy Advances Dengue DNA Vaccine Using Its Vaxfectin Adjuvant ... DNA vaccine formulated with the company's Vaxfectin adjuvant.

**Vical Says US Navy Advances Dengue DNA Vaccine Using Its ...**

[www.patriotfiles.com](http://www.patriotfiles.com) > The Patriot Files Forums > Military News > Navy ▾

Mar 5, 2012 - 2 posts

Vical Says US Navy Advances Dengue DNA Vaccine Using Its Vaxfectin Adjuvant RTT News (RTTNews) - Vical Inc. (VICL: News ) said the ...



# investors

## INVESTORS

Home / Investors / News Releases / News Release Details

Print this Page | 

Overview

What's in Vical's DNA?

Stock Information

News Releases

Events & Presentations

SEC Filings

Briefcase

Fact Sheet

IR & Media Contacts

## U.S. Navy Advances Dengue DNA Vaccine Using Vical's Vaxfectin® Adjuvant

03/05/2012

SAN DIEGO, March 5, 2012 (GLOBE NEWSWIRE) – Vical Incorporated (Nasdaq:VICL) today announced that the Naval Medical Research Center (NMRC) has initiated a Phase 1 human clinical trial of a tetravalent dengue DNA vaccine formulated with the company's Vaxfectin® adjuvant. The trial is based on exciting efficacy data from a nonhuman primate study recently published in the journal *Vaccine*<sup>1</sup>. Vical manufactured the vaccine and the adjuvant for both the preclinical and clinical studies, and is providing regulatory and clinical expertise to NMRC for the dengue program.

Vical completed three prior Phase 1 trials, with no safety issues and no dose-limiting toxicity, of Vaxfectin®-formulated DNA vaccines against H5N1 and H1N1 pandemic influenza.

Under a prior Collaborative Research and Development Agreement (CRADA) with Vical, NMRC developed a tetravalent DNA vaccine (TVDV) containing genes encoding the pre-membrane (prM) and envelope (E) proteins for all four serotypes of dengue virus, and formulated with Vical's Vaxfectin® adjuvant. Both Vaxfectin®-formulated and unformulated vaccines are now being evaluated in Phase 1 human testing. A total of 40 subjects will be assigned to three dose groups: a low dose TVDV without adjuvant, a low dose TVDV with Vaxfectin® adjuvant, or a high dose TVDV with Vaxfectin® adjuvant. Vaccines will be administered by intramuscular injections on days 0, 30 and 90, with follow-up through approximately one year. Key endpoints in the trial will be safety and immunogenicity.

The recently published preclinical TVDV immunogenicity and challenge data indicated that Vaxfectin® significantly improved neutralizing antibody responses and significantly enhanced protection against challenge. Nonhuman primates received the tetravalent DNA vaccine, formulated with or without the Vaxfectin® adjuvant, or a blank DNA control, on days 0, 28, and 84. All four (100%) rhesus macaques receiving the Vaxfectin®-formulated vaccine developed neutralizing antibodies to all four serotypes of dengue by one month after the second injection, compared with none of the four (0%) macaques receiving the unformulated vaccine and none of the three (0%) unvaccinated control animals. By one month after the third injection, all (100%) macaques in both vaccine groups (Vaxfectin®-formulated and unformulated) developed neutralizing antibodies to all four serotypes of dengue, compared with none (0%) of the unvaccinated control animals.

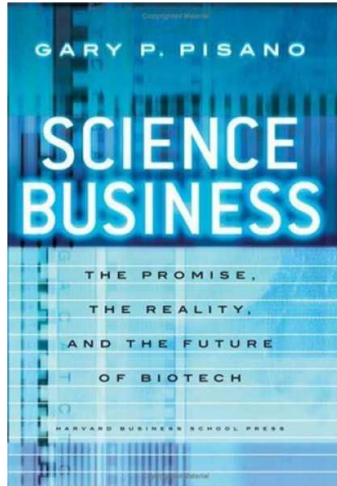
 ShareThis

Em relação a opiniões de experts...

# E daí?

- Quais são os objetivos da instituição?
- Quais são as perguntas a serem respondidas?

# Leitura Recomendada



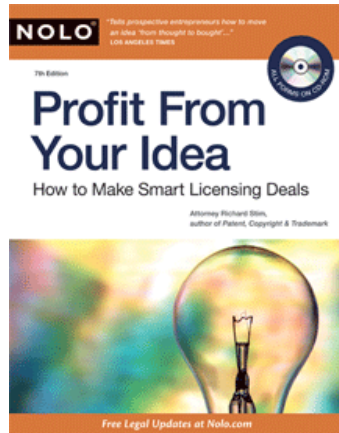
Science Business  
Gary Pisano



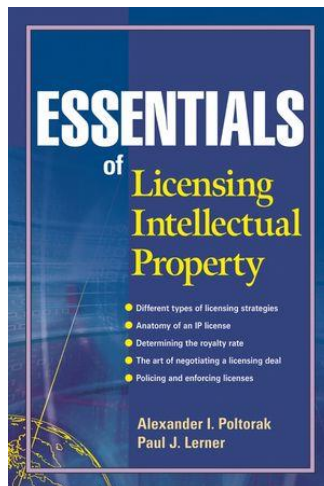
Patent It Yourself  
David Pressman



# Leitura Recomendada



## Profit From Your Idea Richard Stim

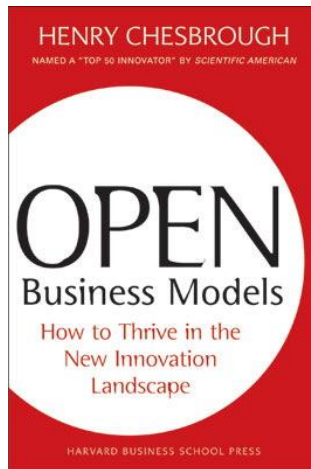


## Essentials of Licensing Intellectual Property Alexander Poltorak & Paul Lerner

# Leitura Recomendada



Open Innovation  
Henry Chesbrough



Open Business Models  
Henry Chesbrough



**Muito obrigado pela atenção!**

**Henry Suzuki**

henry.suzuki@axonal.com.br

**Axonal Consultoria Tecnológica Ltda.**

www.axonal.com.br



**CRF-AC**



# Oficina: Inovação Farmacêutica & Propriedade Intelectual

FAMETA  
Rio Branco, AC  
06 de abril de 2018

## Apoiadores



## Mantenedores da Academia de Ciências Farmacêuticas do Brasil

Diamante:



Prata:



